

TEMPORARY TRAFFIC CONTROL MANUAL 2024

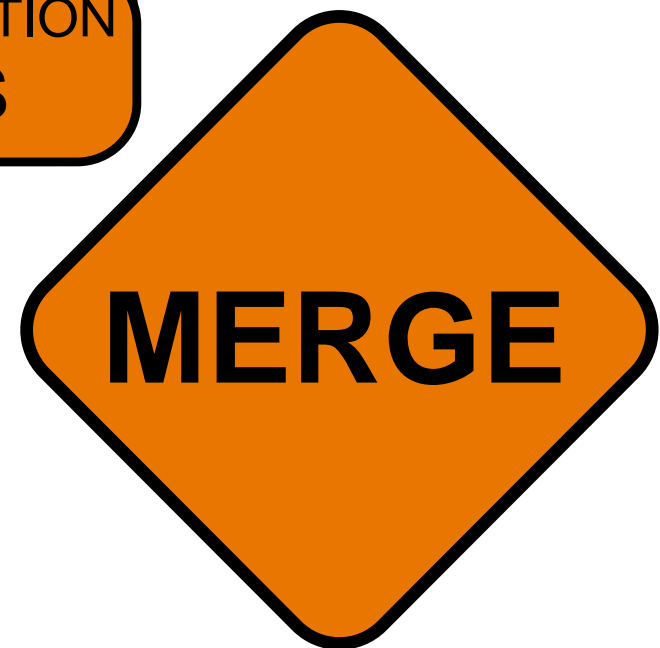
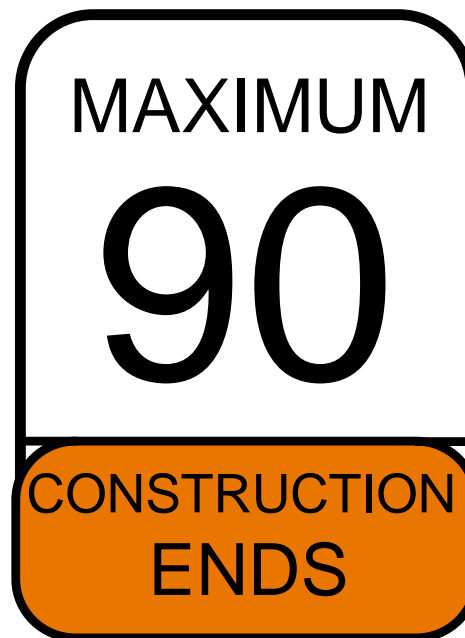
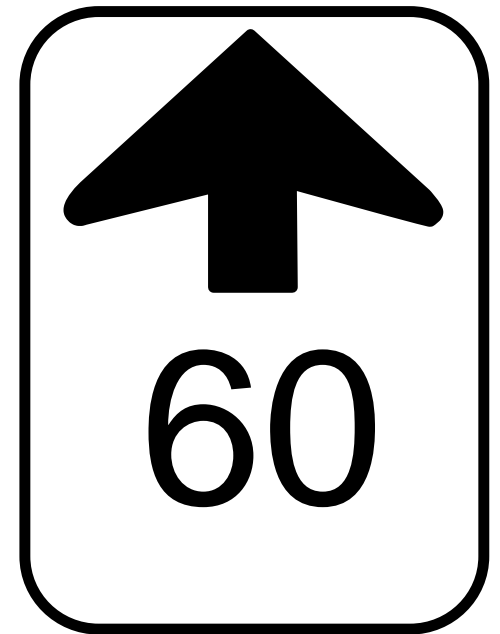
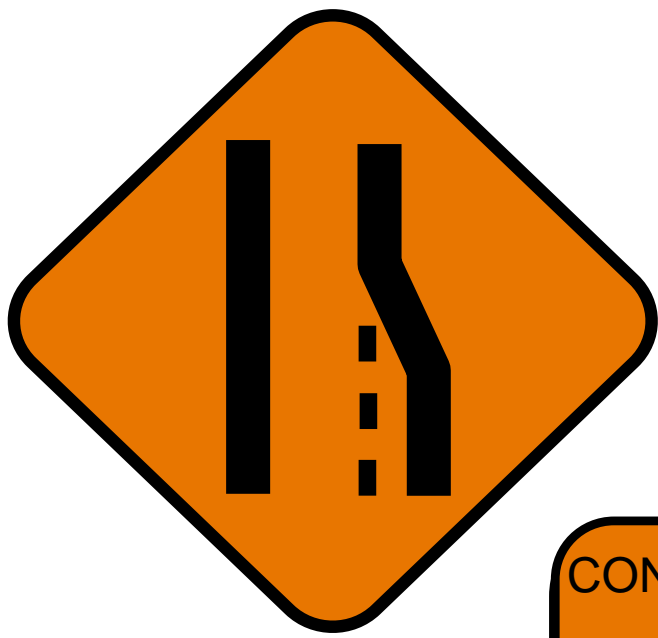

TEMPORARY TRAFFIC CONTROL MANUAL (2024)

CHAPTER 1 – INTRODUCTION

Purpose.....1
Scope.....1
Authority.....1

CHAPTER 2 – BEFORE YOU WORK ON CITY ROW (RIGHT-OF-WAY)

Worksite assessment and checklist2
 Before the job2
 During the job2
 After the job3
Required permits / Authorization3
Requirements for Night work.....3
Saskatchewan temporary traffic control accreditation4
Traffic control person (flag person) accreditation4

CHAPTER 3 – PERFORMANCE GUIDELINES

Pedestrian safety5
Standards of performance and responsibility5
Securing the work site8
 During periods on activity.....8
 During periods of inactivity.....9
 Bridging.....9
Installation and maintenance10
 Installation.....10
 Maintenance10
 Record Keeping10
Temporary work zone component areas.....10
Basic TTC tapers and tangents criteria12
Duration of work12
 Mobile12
 Very short duration12
 Short Duration.....12
 Long Duration12
Restricted areas16
 Heavy rail ROWs (CN, CP).....16
 Idylwyld Drive/Freeway and Circle Dr16
 Central Business District.....16

CHAPTER 4 – GUIDELINES FOR TRAFFIC CONTROL DEVICES

Signs and specifications..... 17
Control of traffic using a traffic control person 26
Delineation (channelization) devices 28
Barricades 30
 Acceptable use of barricades..... 30
 Non-acceptable use of barricades 30
 Light barricades 31
 Cone Bars 32
 Heavy barricades 33
 Wheelchair Ramps 34
Traffic barriers 35
Arrow boards 36
Variable message boards 37
Impact attenuators 37

CHAPTER 5 – TEMPORARY TRAFFIC CONTROL (TYPICAL APPLICATIONS)

Drawing Index 38

GLOSSARY 124

APPENDIX

TTC Checklist..... 131
Lane Designations 132
Traffic Bylaw..... 133
Roadway Classification Map (printed version only)..... 134

CHAPTER 1 – INTRODUCTION

PURPOSE

The purpose of this traffic control manual is to set out mandatory standards and specifications for temporary traffic control designed for:

1. The safety of employees at the work site.
2. The safety of motorists, cyclists and pedestrians within the traffic zone.
3. The protection of equipment used at the work site.
4. Minimizing traffic disruption around the work site.

SCOPE

This manual is intended as a practical mandatory standard to be used by private contractors, consultants, utility companies and City personnel. Uniform standards and procedures are set out in this manual and shall be adhered to when working on or adjacent to roadways under the jurisdiction of The City of Saskatoon. The TTCPs (Temporary traffic Control Plans) in this manual are intended to be a guide for the site-specific plans that are required when working on or adjacent to City of Saskatoon roadways.

All agencies and contractors shall observe and maintain these standards to ensure:

1. Uniform standards for design and quality of traffic control devices within The City of Saskatoon Right of Way (ROW).
2. Standardized procedure and placement of traffic control device to minimize confusion for all users.
3. The promotion of uniform design and standard throughout Canada.

This manual shall be used in conjunction with the *Employment Standards Act* and *The Traffic Safety Act*, The National Building Code and associated regulations, all applicable bylaws and related contract documents.

AUTHORITY

All work performed on City-owned ROW shall conform to the policies, standards and procedures set out by The City of Saskatoon including this Temporary Traffic Control Manual and the *Saskatchewan Employment Standards Act*.

The Transportation Division manager is the final authority on temporary traffic control standards and sets the extent of traffic disruption allowed on all City-owned ROW. As such, the Transportation Division must be notified in advance of expected start date (policies found on the City of Saskatoon website, www.saskatoon.ca/detourrequests) before commencing work on, or adjacent to, all City-owned ROW.

CHAPTER 2 – BEFORE YOU WORK ON CITY ROW

WORKSITE ASSESSMENT AND CHECKLIST

BEFORE THE JOB

1. Has the Transportation Division approved your work order and traffic accommodation plan?
2. Do you need assistance from the Detour Group, Transportation, for temporary traffic control?
3. Do you have the necessary permits (ROW permit)?
4. Is a tree protection plan required? (Contact Parks – Urban Forestry)
5. Do you require a temporary parking accommodation plan?
6. Have you contacted Saskatoon Transit if you are working on a bus route?
7. Have you given adequate advance notice of the work that you plan to do to the affected businesses, utilities and residents (by means of a letter drop)? Has this letter been approved by the Transportation Division?
8. Are the proper temporary traffic control devices available at the worksite to accommodate traffic?
9. Are the pedestrians and motorists properly separated and protected from each other and the work site?
10. Access for emergency vehicles shall be maintained at all times. Have you done everything to ensure emergency access?
11. Do you have a Temporary Traffic Control Checklist? (See Appendix)

DURING THE JOB

1. Is there enough proper equipment available to secure the worksite overnight if necessary? Remember, you will need reflective signs, markers, flashers and sandbags for your set-up. You also may need bridging materials, snow fence and barricades for the worksite. Are there signs that need to be covered or removed during periods of inactivity?
2. Are all the traffic control devices still in their proper places, aligned and standing upright? Do you need to secure signs with sandbags? Are the signs clean and legible (day and night)?
3. If a traffic control person is being used, are proper procedures being followed? Has the traffic control person(s) been trained by an accredited institution? (IMSA)
4. Does the traffic set-up continue to meet the needs of your job? If not, seek approval from Detour Group, Transportation, to modify and make changes.
5. Is the work zone being monitored as specified?
6. Do you have an approved contingency plan in place to accommodate peak hour traffic if there is the possibility that the work may run into the peak hours?
7. Have arrangements been made for paving materials to bring the ROW back into service?

AFTER THE JOB

1. Have you obtained approval from the Transportation Division to reopen the roadway?
2. Have you cleaned up the worksite and rehabilitated the ROW in a condition equal to or better than it was prior to the start of work?
3. Have arrangements been made to restore or rehabilitate the ROW?
4. Have you removed all temporary traffic control devices?

OH&S TRAFFIC PLAN REQUIREMENTS

According to OH&S regulations, a temporary traffic control plan must be as per 0-1.1 Regulation 1, Section 133, and **Subsection 7**:

(7) A traffic control plan required by subsection (6) must:

- a) *Be in writing*
- b) *Be made readily available for reference by workers at the place of employment; and*
- c) *Set out, where appropriate:*
 - i. *The maximum allowable speed of any vehicle or class of vehicles, including powered mobile equipment, in use at the place of employment;*
 - ii. *The maximum operation grades;*
 - iii. *The location and type of control signs;*
 - iv. *The route to be taken by vehicles or powered mobile equipment;*
 - v. *The priority to be established for classes of vehicle;*
 - vi. *The location and type of barriers or restricted areas; and*
 - vii. *The duties of workers and the employer or contractor.*

REQUIRED PERMIT / AUTHORIZATION

All work on City-owned ROW requires authorization and, in certain situations, may require a permit. For information on required authorization and permits, contact Transportation at rowpermits@saskatoon.ca

REQUIREMENTS FOR NIGHT WORK

When working at night adequate lighting must be present on all work sites. Nighttime work sites must be illuminated to **50 lumens per square meter** at all times. A lighting plan must be created by any contractor working at night on or adjacent to City of Saskatoon roadways. Contractors can add the lights they will need to the TTCP that they have received or created.

TEMPORARY TRAFFIC CONTROL ACCREDITATION

All persons designing temporary traffic controls (TTC) should be accredited by an appropriate agency. Accreditation will assist all parties involved in understanding and implementing temporary traffic control practices and procedures for construction worksites in the province of Saskatchewan.

TRAFFIC CONTROL PERSON (FLAGPERSON) ACCREDITATION

Any individual who will be acting as a traffic control person shall be properly trained and certified in flagging. Certification can be obtained through the Heavy Construction Safety Association, Saskatchewan Safety Council or other accredited agencies.

TEMPORARY TRAFFIC CONTROL – FIELD APPLICATIONS ACCREDITATION

At least one person involved in the implementation of TTC plans must be accredited by an appropriate agency. It is recommended that all persons involved in the implementation of TTC plans be accredited by an appropriate agency.

CHAPTER 3 – PERFORMANCE GUIDELINES

PEDESTRIAN AND CYCLIST SAFETY

As per City Council Policy C07-032, the safety of pedestrians, cyclists and motorists must be considered in the design, set-up and operation of a temporary traffic control situation.

1. Pedestrian and vehicular traffic must be physically separated.
2. Pedestrian traffic must be physically separated from workers and equipment in the work area. Accommodations must be made for a safe passage through or around the work area. For example, crosswalks and sidewalks may be closed to prevent pedestrian traffic through or around the work area, provided alternate means of detouring pedestrian traffic is available. If a sidewalk must be closed for a short duration to complete work safely, the sidewalk on the other side of the roadway must remain open and usable for pedestrians. In cases where it is not possible to detour pedestrian traffic to the other side of the roadway, and/or for long durations (6 months or more), pedestrians will have to be protected as they pass through the work area. This may require the use of barricades to separate the worksite from the pedestrian walkway. It may be necessary to use bridges (complete with handrails) and sheltered walkways. In all cases, measures taken to protect the pedestrians must be to the satisfaction of the manager of Transportation.
3. A pedestrian diversion must provide a reasonably safe, continuous, accessible and convenient route with a smooth hard surface with continuous detectable edges and accessible features (grades and ramps) consistent with the affected facility. Detectable warnings are required at temporary asphalt pedestrian curb ramps.
4. A bicycle detour route must provide a reasonably safe, continuous, accessible and convenient route with a smooth hard surface and features consistent with the affected facility.

Specifications used for bridges and hoarding must be reviewed by the Transportation Division prior to commencing any work.

STANDARDS OF PERFORMANCE AND RESPONSIBILITY

With the exception of emergency related work, all work on City-owned ROW shall:

1. Be approved by the Transportation Division under authority of the manager. They will set the extent of traffic disruption allowed. They will determine temporary traffic control necessary for the work proposed.
2. Be pre-authorized and reported to the Transportation Division in advance of expected start date. The Roadway Activity Group can be contacted at tu.detourgroup@saskatoon.ca and detour request forms and information can be found at www.saskatoon.ca/detourrequests
3. Require authorization and/or a special permit when working in restricted areas.
4. Require a Building or Demolition Permit from Building Standards before building or demolition is started.

5. In the case of emergency related work (after business hours), contact Public Works Customer Service Centre before work is started. Phone Public Works Customer Service Centre at 306-975-2476 (9-1-1 for life threatening situations). Notify of the location of any detour or diversion on any arterials, expressways or freeways. Always use qualified traffic control persons or the Saskatoon Police Service (306-975-8300) to supplement an incomplete set-up under these circumstances.

In all cases:

1. All necessary traffic control devices must be in place before work commences. These devices shall be maintained by the contracting agency for the duration of work/temporary traffic control while any obstruction to traffic exists. These devices shall remain in place for the duration of the work. The approved traffic control plan will be maintained at the worksite.
2. Minimum driving lane width shall be 3.0 metres per lane. This width shall be adjusted upward under circumstances such as curves, heavy vehicle traffic, truck routes and high-speed situations. Bus routes require a minimum driving lane width of 3.5m
3. In the city centre or other areas of high pedestrian volumes, the minimum sidewalk width shall be 2.0 metres. In other parts of the city, the minimum sidewalk width shall be 1.8 metres or match the existing width of the current sidewalk infrastructure. This width shall be adjusted upwards under such circumstances as the likelihood of people using mobility aids or heavy pedestrian traffic. The path of travel shall be free from obstructions for the full width of the walk to a minimum height of 2.4 metres.
4. Minimum bike lane width shall be 1.5 metres per lane. This width shall be adjusted upwards under such circumstances as curves, heavy truck traffic or high-speed situations. Path of travel shall be free from obstructions for the full width of the lane to a minimum height of 2.5 metres.
5. Minimum multi-use pathway shall be 2.0 metres clear width with no obstructions or encroachments. The width shall be adjusted upwards under such circumstances as the likelihood of people using mobility aids or heavy pedestrian and cyclist traffic. Path of travel shall be free from obstructions for the full width of the pathway to a minimum height of 2.5 metres.
6. Sidewalks shall be smooth, free of tripping hazards, provide positive drainage, have detectable edges and adequate lighting.
7. Channelized pedestrian detours in the city-centre or high pedestrian traffic areas (transit stops) shall be illuminated for 24-hour use.
8. Multi-use pathways shall be smooth, free of tripping hazards and provide positive drainage.
9. Store vehicles and equipment outside of the pedestrian route.
10. Limit site access across the pedestrian route to controlled points and maintain the pedestrian route surface at the site access driveways (remove tracked earth, gravel, mud) to provide a smooth surface for pedestrians.
11. Any disruption that may affect pathway operations outside of the City road right-of-way shall be co-ordinated with the Parks Division. Pathway detours within the road right-of-way shall be co-ordinated with Parks and the Transportation Division.

12. Any disruption that may affect on-street bicycle route operations shall be co-ordinated with the Transportation Division. The City Cycling Guide can be found at www.saskatoon.ca/moving-around/cycling/cycling-safety/cycling-guide-tips-and-where-ride.
13. All temporary traffic control set-ups shall be to the satisfaction of the Transportation Division. The set-up shall be maintained satisfactory at all times until normal conditions are restored.
14. Street closures and/or detours may be preferable to using complicated traffic set-ups or traffic control persons. Approval shall be obtained from the Transportation Division in advance of expected start date (policies found on the City of Saskatoon website, www.saskatoon.ca/detourrequests).
15. It is the responsibility of the contractor, utility company or business unit to notify affected residents/businesses of road closures, parking restrictions and other work that impacts normal traffic flow. The recommended method to notify the public of parking restrictions is by advanced signage. Parking services shall be contacted by email at parking.services@saskatoon.ca
16. Requests for paid parking area restrictions and No Parking Zones to be established require advanced notice as per the policies found at www.saskatoon.ca/parkingpermits. No Parking signs shall be placed a minimum of 36 hours prior to commencing work and must not be attached to trees. In either case, the requesting party is responsible for sign maintenance. This zone will only be enforced provided there is enough signage and adequate notice. Parking services email is parking.services@saskatoon.ca
17. Saskatoon Transit must be notified of work affecting a bus route or bus stops. For a simple traffic diversion, Saskatoon Transit requires one full working day advance notice. For a traffic detour, notify Saskatoon Transit at least two full working days in advance. The Detour Group can assist on work affecting transit routes/stops. Avoid delaying transit operations whenever possible noting that consecutive bus stops along a route cannot be closed unless approval has been given by the Transportation Division.

Other possible cases:

1. In case of emergency work affecting Saskatoon Transit, contact the Saskatoon Transit Detour group by email at dITUTransitServiceSupervisors@Saskatoon.ca
2. Waste & Recycling Services (306-975-2486) or dITUWWSolidWasteDispatch@Saskatoon.ca shall be notified 36 hours in advance of laneway or street closures affecting garbage pickup for longer than one day. Notify Waste & Recycling Services immediately of emergency work affecting garbage pickup.
3. Rush hour traffic in Saskatoon is typically from 07:00 to 09:00 and from 16:00 to 18:00, Monday to Friday. During these times, construction work is not allowed on arterials, expressways or freeways, except in cases of emergency or with prior approval of the Transportation Division.
4. When traffic lanes within the worksite are required to be open to travel (i.e. during rush hours or at the end of a shift), trenches and small excavation sites may be bridged with steel plates. This should be used only if backfilling all or part of a trench is not practical. Bridging must meet City of Saskatoon standards and specifications.

5. Contracting departments or agencies shall ensure that private contractors and other agencies working for them, maintain City of Saskatoon procedures and standards. Transportation Division may inspect any worksite at any time, and recommendations made by the Transportation Division shall be implemented.
6. The restoration of road surfaces, sidewalks and boulevards must be to the satisfaction of the Public Works – Roadways.
7. Occasionally, an emergency vehicle (e.g. Police, Ambulance, and Fire) will approach the traffic control zone with sirens and lights flashing. Worksite employees are responsible to see that traffic is stopped by accepted traffic control methods so the emergency vehicle may drive safely through the traffic control zone.
8. The Transportation Division shall be notified if a permanent traffic sign has to be removed. This should be reported at the same time as approval for traffic set-up is sought. The Sign Shop shall place a portable sign to replace the permanent sign. The permanent sign must be removed and replaced by the Transportation Division.
9. Any disruption that may affect signal timing or signal operations shall be co-ordinated with the Transportation Division at traffic.operations@saskatoon.ca. In the event of a signal related emergency, after business hours, contact Public Works Customer Service Centre @ 306-975-2476

SECURING THE WORKSITE

Securing the worksite is necessary to protect the public from potentially hazardous conditions within the work zone. It is necessary to secure the worksite during any periods of inactivity and during the period when work is taking place. Some examples of inactivity are shutdowns due to weather conditions, end of shift, weekends, holidays and lunch/coffee breaks. The necessary steps to secure the worksite are outlined below.

DURING PERIODS OF ACTIVITY

1. Ensure that all temporary traffic control devices are legible and properly placed.
2. All devices must be retro-reflective.
3. Remove or securely cover any signs that are not required or are conflicting. For example, cover the gazetted speed if the set-up requires a speed reduction.
4. Place barricades around all stockpiled material, spoil piles and equipment that is stored on the road or the shoulder.
5. All temporary traffic devices shall be properly secured.
6. Inspect the worksite as required and keep a record of the inspection.
7. Once secured, drive and walk the worksite to ensure that the traffic control set-up provides motorists, cyclist and pedestrians with adequate advance warning and provides positive guidance around the worksite. Ensure that safe, convenient and accessible pedestrian and cyclist movement is maintained, and pedestrian and vehicle movement are separated.

8. Arrange to have sidewalks and multi-use pathways within the traffic control zone cleared of snow, ice and debris. If required, sand during periods of icy condition.

DURING PERIODS OF INACTIVITY

1. Where possible, remove all equipment and materials from the roadway.
2. Establish a barrier around open trench/excavations using physical barriers, such as concrete safety shaped barriers, suitable fencing (1.8m solid wire mesh), etc. The location and the nature of the excavation will dictate the method used to provide the necessary safety required. "OPEN TRENCH" or "OPEN PIT" caution signs must be posted conspicuously at the trench/excavation.
3. Place barricades around all stockpiled material, spoil piles and equipment that is stored on the road or the shoulder.
4. Retro-reflective chevrons or flashers shall be used to delineate the tapers. Flashers shall be used to separate the travel lane(s) and the worksite. They shall also be used to identify material and equipment storage on the road or the shoulder. The Transportation Division, Sign Shop, does not supply flashers with their temporary traffic control set-ups. It is therefore the responsibility of the contractor, utility company or other City department to supply and maintain these.
5. All traffic supply devices shall be secured during periods of inactivity.
6. Arrange to have roads within the traffic control zone sanded during periods of icy conditions.
7. Remove or cover any signage that is not required.
8. Inspect the worksite as required and keep a record on the inspections.
9. Arrange to have sidewalks and multi-use pathways within the traffic control zone cleared of snow, ice and debris. If required, sand during period of icy conditions.

BRIDGING

When steel plate bridging is required on city streets, the following standards shall be maintained:

- Contact Transportation Division to determine the necessary set-up required (for example, plating may require a speed reduction)
- Bump signs shall be provided for each traffic direction.
- All bridge edges must be smoothed out or feathered using hot or cold mix asphalt.
- All bridge plates must be adequately pinned to the road surface to prevent bridge movement.
- Temporary hazard markers shall be used to mark the location of bridging plates.
- Insulate the plates to prevent banging, especially in the vicinity of residential communities.
- Define/highlight the edges of the plating with high visibility material, such as fluorescent orange paint.

INSTALLATION AND MAINTENANCE

INSTALLATION

All devices shall be placed in a manner so as not to interfere with existing traffic control devices. It is important to survey the site before preparing a temporary traffic control plan. This ensures any conflicting signs are covered or removed. For example, if a speed reduction is required, the gazetted signs shall be covered or removed. Work in the proximity of a signalized intersection may require signal timing revision based on the circumstances. Revise road markings where required and remove redundant road markings or addition of new markings.

MAINTENANCE

It is important to maintain all temporary traffic control devices. Some examples of maintenance include, but are not limited to:

- Cleaning all signs and devices
- Replacing damaged or illegible signs & barricades
- Ensuring all signs and devices are located as per plan
- Ensuring all signs and devices are secured for adverse conditions
- Cleanliness and operation of flashing lights for night use

RECORD KEEPING

Record Keeping is an important component of temporary traffic control to document and ensure the appropriate measures are in place at all times. The project supervisor is responsible for maintaining a record of the temporary traffic control used and taking the necessary steps to correct any deficiencies. This may include contacting the Transportation - Detour Group, other providers of traffic control or, in the case where the contractor has been given the authority to provide its own traffic control, correcting the deficiency.

TEMPORARY WORKZONE COMPONENT AREAS

A typical temporary traffic control set-up can be divided into five areas:

1. Advance warning area: this area is used to inform the road users of the upcoming work zone and what action to take.
2. Transition area: this area is used to move the road users out of the normal path.
3. Buffer area: this area provides protection for traffic and workers.
4. Work area: this is the area where the work takes place.
5. Termination area; this area is used to allow the road users to return to their normal path.

Please refer to the diagram Components of a Temporary Traffic Control Zone, which details the above areas.

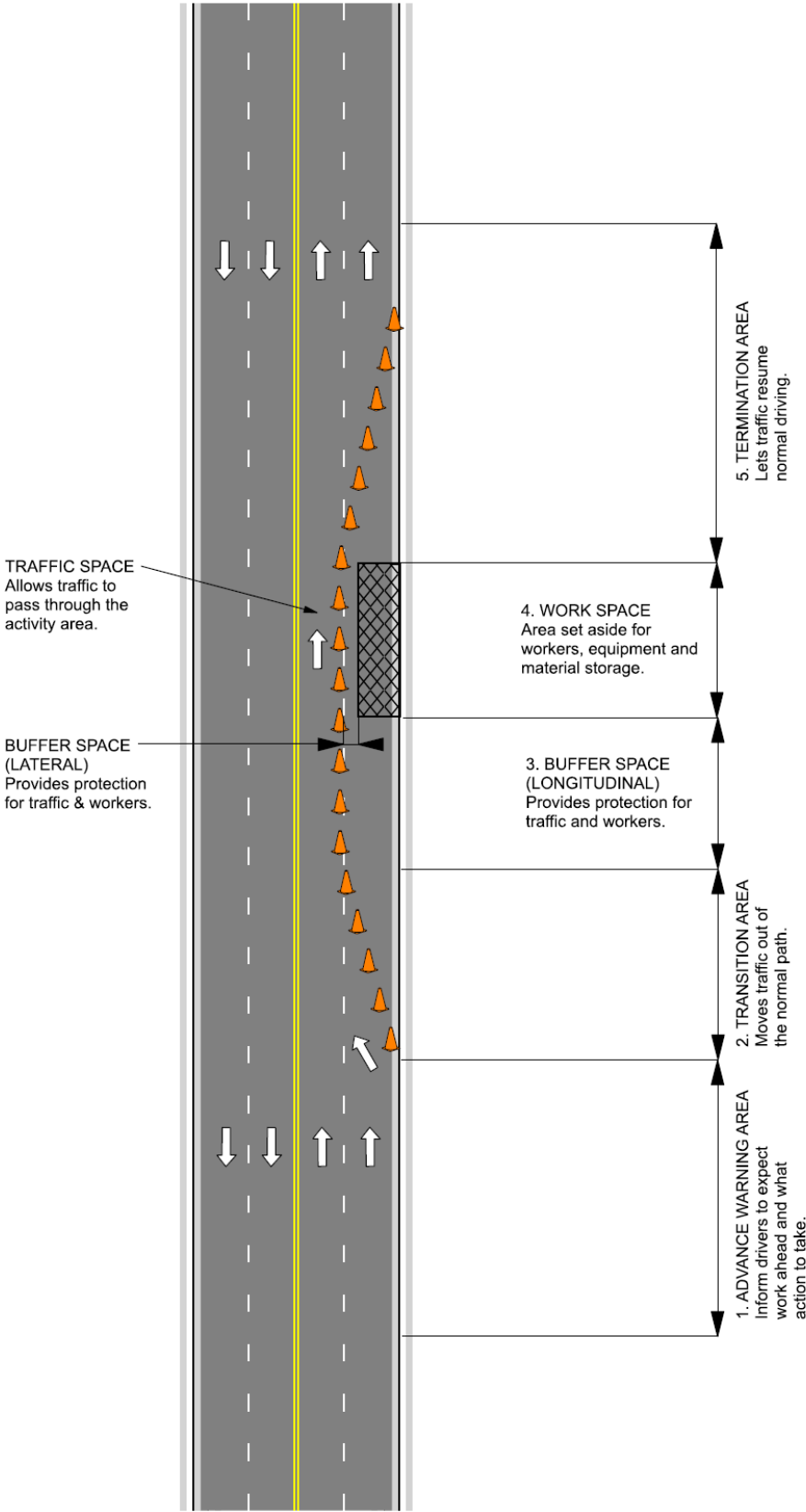

BASIC TTC TAPERS AND TANGENTS CRITERIA

<i>TYPE OF TAPER</i>	<i>TAPER LENGTH (L) (METRES)</i>
Merging Taper – 2 lanes to 1 (lane closure)	L Minimum
Shifting Taper	L/2 Minimum
Shoulder Taper	L/3 Minimum
One Lane – two-way traffic taper	30m Maximum
Downstream Taper	30m Minimum

<i>TANGENTS BETWEEN TAPER</i>	<i>TAPER LENGTH (L) (METRES)</i>
Merging followed by merge	2L (desirable) L (minimum)
Merge followed by shift	L/2

Please refer to pages 13-15 for diagrams of tapers and the chart used to calculate the various lengths.

DURATION OF WORK

MOBILE

- Mobile operations are those typically performed on the move at low speed and may require periodic stopping for only a few minutes.
- Examples of mobile operations are: street sweeping, longitudinal pavement marking, and watering of trees.

VERY SHORT DURATION

- Very short duration operations are those can be completed in 30 minutes or less and may be stationary or mobile with frequent short stops.
- Examples of very short duration operations are: minor utility and roadwork, crack sealing, catch basin cleanout, pothole patching/repair, symbol and transverse road markings, minor sign maintenance, signal light replacement and emergency response (e.g. spills and vehicular accidents)

SHORT DURATION





- Short duration operations are stationary and range between 30 minutes and 24 hours.
- Examples of short duration operations are: maintenance, sidewalk/boulevard repair, utility work, asphalt patching, emergency water main repairs and emergency response.

LONG DURATION

- Long durations are stationary and take longer than 24 hours.
- Examples of long duration operations are: manhole replacement, utility replacement, bridge rehabilitation, roadway upgrading, large paving operations and sidewalk/boulevard replacement.

GUIDELINES FOR LANE CLOSURE TAPERS AND LONGITUDINAL BUFFER SPACE

The guidelines for lane closures tapers and longitudinal buffer space are in the table below. The distances used in this table are a minimum standard and can at times be adjusted.

GUIDELINES FOR LANE CLOSURE TAPERS AND LONGITUDINAL BUFFER SPACE						
V(km/h)	A(m)	L(m)	B(m)	D(m)		
50	50	30	35	8		
60	50	40	45	12		SHORT TERM
70	75	60	50	15		LONG TERM
80	100	80	60	15		
90	100	105	65	18		
100	125	125	70	18		

Where:
V = Posted Speed Limit
A = Spacing between Signs
L = Length of Taper
B = Length of Longitudinal Buffer Space
D = Spacing between Delineation Devices

A description of how to use the above table is as follows:

- 1st column of the guideline (V) is the gazetted (permanent) posted road speed on the road that the closure is taking place on (not the temporary speed that is needed for a closure)
- 2nd column (A) will dictate the spacing between signs as per the gazetted speed in column 1 (V)
- 3rd column (L) is the length of your taper as per the gazetted speed in column 1 (V). The taper is a gradual process of merging traffic from two lanes to one lane, and away from the work-zone area
- 4th column (B) is the length of your buffer zone as per the gazetted speed in column 1 (V). The buffer zone is there to provide a space between the taper and the actual work-zone
- 5th column (D) is the maximum allowed spacing between delineation devices (cones, barrels, etc.) as per the gazetted speed in column 1 (V). Less spacing between delineation devices is encouraged.

In the table go to the 1st column (V) and go down the table to find the gazetted speed of the road your closure is on (ex: 90 Km/h). This will be the line you will use for the closure set up. With a gazetted road speed of 90km/h; Column (A) sign spacing should be 100 metres, Column (L) taper length should be 105 metres, Column (B) buffer space should be 65 metres and Column (D) maximum spacing for delineation devices should be 18 metres.

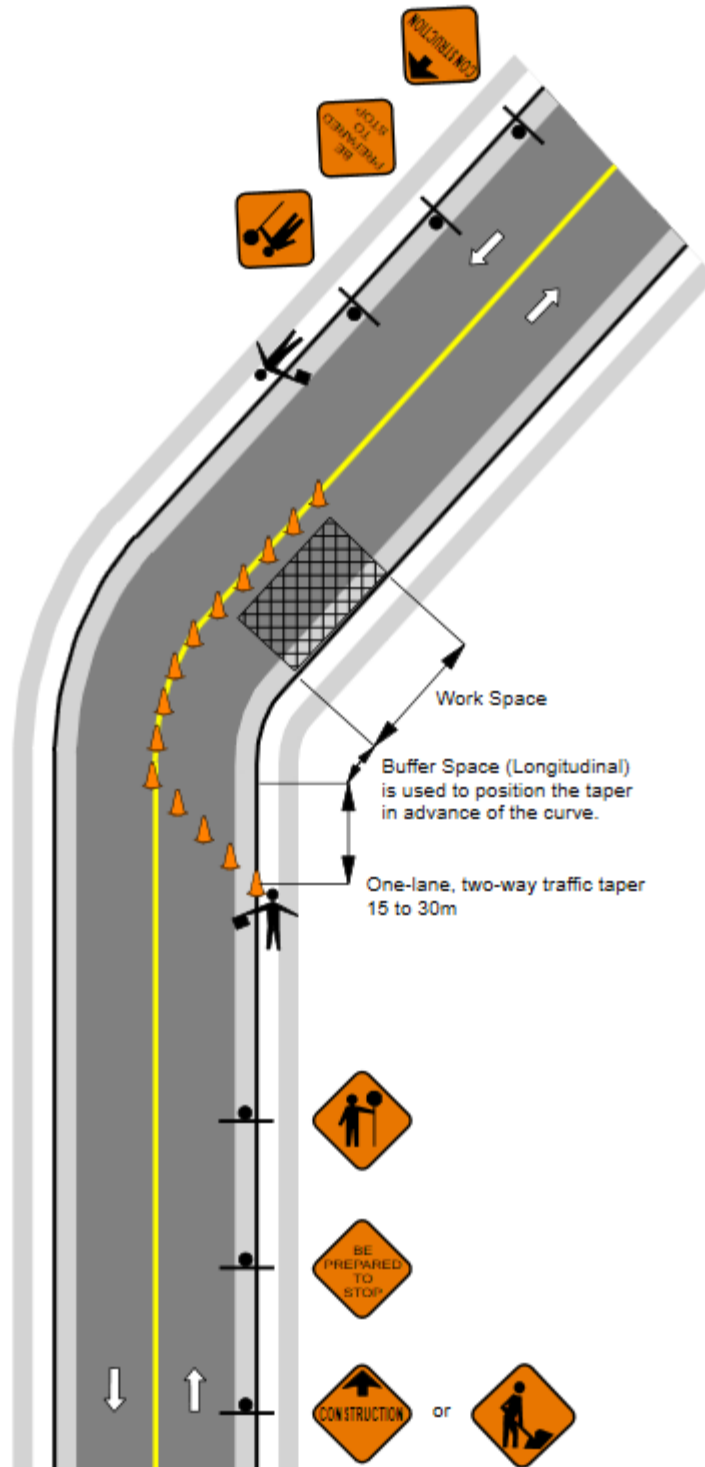

ONE-LANE, TWO-WAY TRAFFIC TAPER

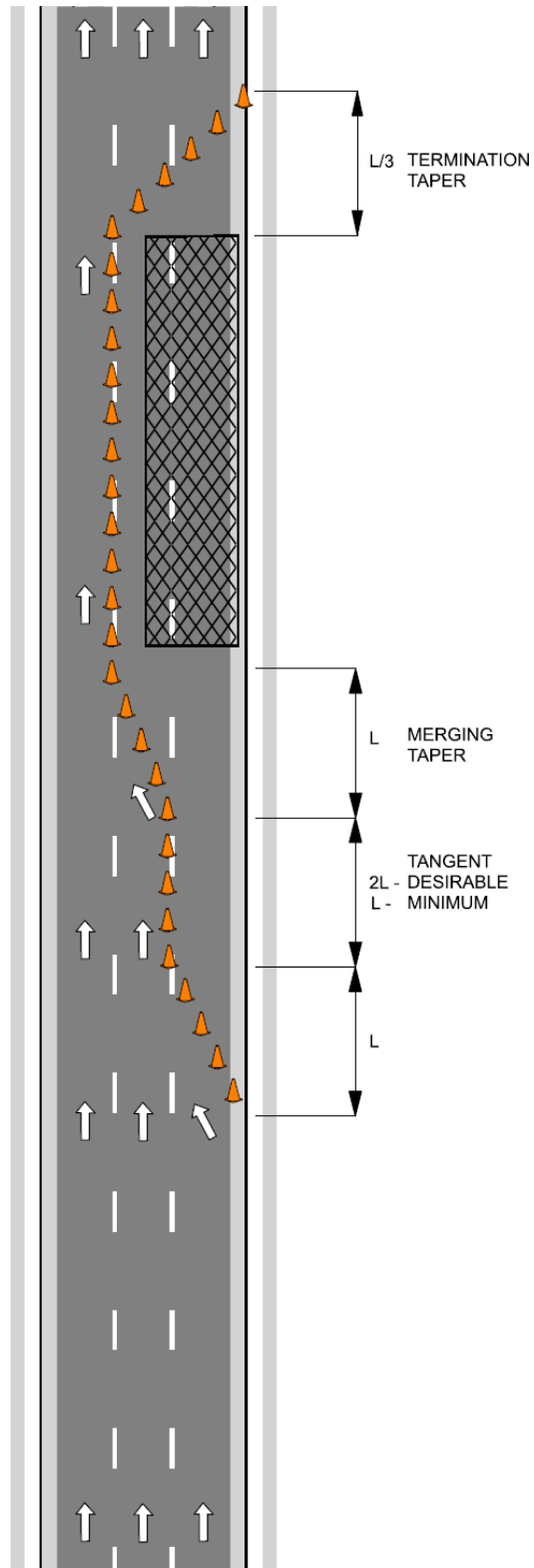

NOTE:
This drawing is a graphical representation of the detour setup. It is NOT drawn to scale.

GUIDELINES FOR LANE CLOSURE TAPERS AND LONGITUDINAL BUFFER SPACE					
V(km/h)	A(m)	L(m)	B(m)	D(m)	
50	50	30	35	8	
60	50	40	45	12	SHORT TERM
70	75	60	50	15	
80	100	80	60	15	LONG TERM
90	100	105	65	18	
100	125	125	70	18	

Where:
V = Posted Speed Limit
A = Spacing between Signs
L = Length of Taper
B = Length of Longitudinal Buffer Space
D = Spacing between Delineation Devices

MERGE TAPER FOLLOWED BY A MERGE TAPER

RESTRICTED AREAS

HEAVY RAIL RIGHT-OF-WAYS (CN, CP)

All work that encroaches upon either the Canadian National (CN) or the Canadian Pacific (CP) rail ROWs shall be co-ordinated through the associated company. For approval and requirements regarding temporary traffic control, contact CN at 800-665-5662 and CP at 888-333-8111.

IDYLWYLD DRIVE / FREEWAY AND CIRCLE DRIVE

Planned maintenance and construction activities must be scheduled outside of the hours of 06:30 to 18:30, Monday through Saturday, unless authorized by the Transportation Division through a Use of Right-of-Way permit.

DOWNTOWN SASKATOON

Idylwyld Dr east to Spadina Cres and 25th St south to Spadina Cres inclusive. Planned maintenance and construction activities must be scheduled outside of the hours of 07:00 to 18:00, Monday through Saturday, unless authorized by the Transportation Division through a Use of Right-of-Way permit.

CHAPTER 4 – GUIDELINES FOR TRAFFIC CONTROL DEVICES

SIGNS AND SPECIFICATIONS

Below is a listing of common temporary traffic control signs. The sizes are recommended under normal conditions. Sign sizes are dictated by roadway classification or by Transportation Engineering. Refer to the Manual of Uniform Traffic Control Devices (MUTCD) for sign sizes that are not identified below. Size, colour and shape shall be in accordance with the most current version of the Manual of Uniform Traffic Control Devices for Canada.

All signs, unless otherwise specified, must be retro-reflective. Retro-reflective sheeting that is classified as Engineering Grade, Reflectivity Level II, is the minimum intensity used in temporary traffic control signage. High intensity material (Reflectivity Level VII) is recommended and is used by the City.

LEGEND

Sign name (MUTCD Code)

- Sign description
- Sign size
- Colour information

REGULATORY SIGNS

Regulatory signs are used to identify a traffic regulation that is applicable at a given time or place on a road and to identify the legal requirement. The following codes are used to categorize the various regulatory signs as below:

RA: right-of-way control signs

RB: road use control signs

RC: miscellaneous regulatory signs



Stop sign (RA-1)

- This sign indicates to drivers that they must come to a complete stop and must not proceed until safe to do so.
- 600mm x 600mm
- White text and border on red background



Multi-way Stop tab (RA-1S4)

- This sign indicates there are more than two approaches controlled by stop signs
- 300mm x 150mm
- White text and border on red background



Yield sign (RA-2)

- This sign indicates to drivers must yield to the ROW, stop if necessary and must not proceed until safe to do so
- 750mm all sides
- Red symbol and border on white background



Maximum Speed sign (RB-1)

- This sign indicates the maximum legal speed
- 600mm x 750mm
- Black text and border on white background



Maximum Speed Ahead sign (RB-5)

- This sign provides advance warning of a speed reduction
- 600mm x 750mm
- Black text and border on white background



Right/Left Turn Prohibited Sign (RB-11R / RB-11L)

- This sign indicates that a right or left turn is prohibited
- 600mm x 600mm
- Black arrow and border, with red circle and bar on white background



Entry Prohibited (RB-23)

- This sign indicates that access to vehicular traffic is prohibited
- 600mm x 600mm
- Black border, red symbol on white background



Two-way Traffic (RB-24)

- This sign indicates that the section of road is a two-way road.
- 600mm x 750mm
- Black symbol and border on white background



Right/Left Turn Only Lane sign (RB-41R / RB-41L)

- This sign indicates to drivers that they must turn from the designated lane at the intersection
- 600mm x 600mm
- White arrow and border on black background



Parking Control sign (RB-51)

- This sign indicates that parking is prohibited at all times on all days and on both sides of the sign. Various prohibitions to time, duration and coverage may be specified
- 300mm x 300mm
- Black symbol and arrows with red circle and bar, and black border on white background



Stopping Prohibited Sign (RB-55)

- This sign indicates that stopping is prohibited at all times on all days and on both sides of the sign. Various prohibitions to time, duration and coverage may be specified
- 300mm x 300mm
- Black symbol and arrows with red circle and bar, and black border on white background



Turn Right/Left Sign (RB-14R / RB-14L)

- This sign indicates to drivers that all lanes must turn right
- 600mm x 600mm
- Black symbol and border with green circle and white background



Keep Right sign (RB-25)

- This sign indicates to drivers that they must pass to the right of obstructions, such as medians, islands or underpass piers
- 600mm x 750mm
- Black symbols and border on white background

One-Way sign (RB-21)



- This sign indicates to drivers that they are allowed to travel only in the direction of the arrow.
- 900mm x 300mm
- White symbol and border on black background

TEMPORARY CONDITION SIGNS

Temporary Condition signs are used for temporary traffic control and have an orange background with black symbol or text.



Road Work sign (TC-2)

- This sign indicates that activities, such as minor maintenance or utility operations, are in progress on or adjacent to the road.
- 750mm x 750mm
- Black symbol and border on an orange background



Construction Ahead sign (TC-1)

- This sign indicates advance warning of a major work zone and are generally used for long-term projects.
- 750mm x 750mm
- Black text, symbol and border on an orange background



Construction Ends sign (TC-4)

- This sign indicates the end of a work zone
- 750mm x 750mm
- Black text and border on an orange background



Temporary Lane Closed Ahead sign (TC-5R / TC-5L)

- This sign indicates that traffic must proceed to the left or right of the closed lane.
- 750mm x 750mm
- Black symbol and border on an orange background



Road Diversion sign (TC-13R / TC-13L)

- This sign indicates a deviation from the normal road, which is => 200m in length
- 750mm x 750mm
- Black symbol and border on an orange background



Road Realignment sign (TC-15R / TC-15L)

- This sign indicates the road is realigned from normal
- 750mm x 750mm
- Black symbol and border on an orange background



Lane Realignment sign (TC-16R / TC-16L)

- This sign indicates the realignment of two or more lanes from normal
- 750mm x 750mm
- Black symbol and border on an orange background



Traffic Control Person Ahead sign (TC-21)

- This sign indicates that traffic is controlled by a traffic control person
- 600mm x 600mm
- Black symbol and border on an orange background



Be Prepared To Stop sign (TC-77)

- This sign indicates that the motorist may be required to stop
- 750mm x 750mm
- Black text and border on an orange background



Two Way Traffic Ahead sign (TC-24)

- This sign indicates the approaching section of road is a two-way road
- 750mm x 750mm
- Black symbol and border on an orange background



Chevron Alignment sign (TC-31)

- This sign indicates a change in the horizontal alignment of the road
- 450mm x 600mm
- Black symbol and border on an orange background



Road Narrows sign (TC-34)

- This sign indicates the narrowing of the road
- 750mm x 750mm
- Black symbol and border on an orange background



Grooved Pavement sign (TC-47)

- This sign indicates that the road surface requires attention by motorcycle or bicycle operators
- 750mm x 750mm
- Black symbol and border on an orange background



Pavement Drop-off sign (TC-49)

- This sign indicates that on the approaching section of road, either or both the adjacent lane or shoulder are lower or higher than the driving lane
- 750mm x 750mm
- Black symbol and border on an orange background



Bump sign (TC-51)

- This sign warns of an approaching bump in the road
- 750mm x 750mm
- Black symbol and border on an orange background



Low Clearance Ahead sign (TC-52)

- This sign indicates the maximum overhead clearance at bridges and other structures
- 750mm x 750mm
- Black dimension, arrows and border on an orange background



Truck Entrance sign (TC-54R / TC-54L)

- This sign indicates trucks entering the roadway
- 750mm x 750mm
- Black symbol and border on an orange background



Squeeze Left/Right sign (TC-67L / TC-67R)

- This sign is used to move traffic from one lane to another
- 600mm x 750mm
- Black symbol, text and border on an orange background



Keep Left/Right sign (TC-68L / TC-68R)

- This sign is used to keep traffic to the side of obstacles or work zones.
- 600mm x 600mm
- Black symbol, text and border on an orange background



Split Traffic sign (TC-78)

- This sign indicates that traffic must go either left or right around an obstacle or work zone.
- 750mm x 750mm
- Black symbol and border on an orange background



Combo Road Closed & Roadwork

- This sign indicates that the road is closed and workers are present
- 600mm x 750mm & 750mm x 750mm
- Black symbol and border on an orange background



Road Closed Ahead – No Exit

- This sign indicates that the road is closed ahead and is there no exit.
- 750mm x 1200mm
- Black symbol and border on an orange background



Sidewalk Closed

- This sign indicates that the sidewalk is closed
- Black symbol and border on an orange background
- An arrow can be attached to the sign as well directing pedestrians to cross the road at a safe location



Sidewalk Closed Ahead / Use Other Side

- This sign indicates that the sidewalk is closed up ahead.
- Black symbol and border on an orange background
- An arrow can be attached to the sign as well directing pedestrians to cross the road at a safe location



Bike Lane Closed

- This sign indicates that the bike lane is closed
- Black symbol and border on an orange background



Bike Lane Closed Ahead

- This sign indicates that the bike lane is closed ahead.
- Black symbol and border on an orange background



Share the Road (WC-20)

- This sign indicates that the roadway needs to be shared by motorists and cyclists
- Black symbol and border on a yellow background (can a be an orange background as well)

The following diagram shows an example of a typical portable sign stand.

Portable signs must be placed outside of the pedestrian and bicycle detour routes.

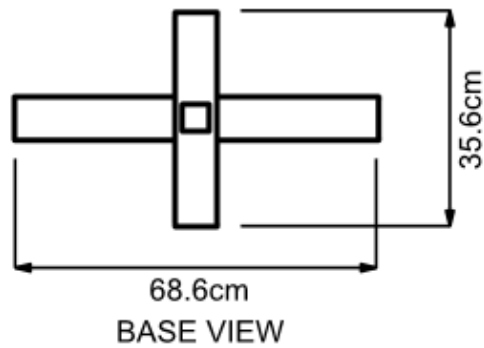
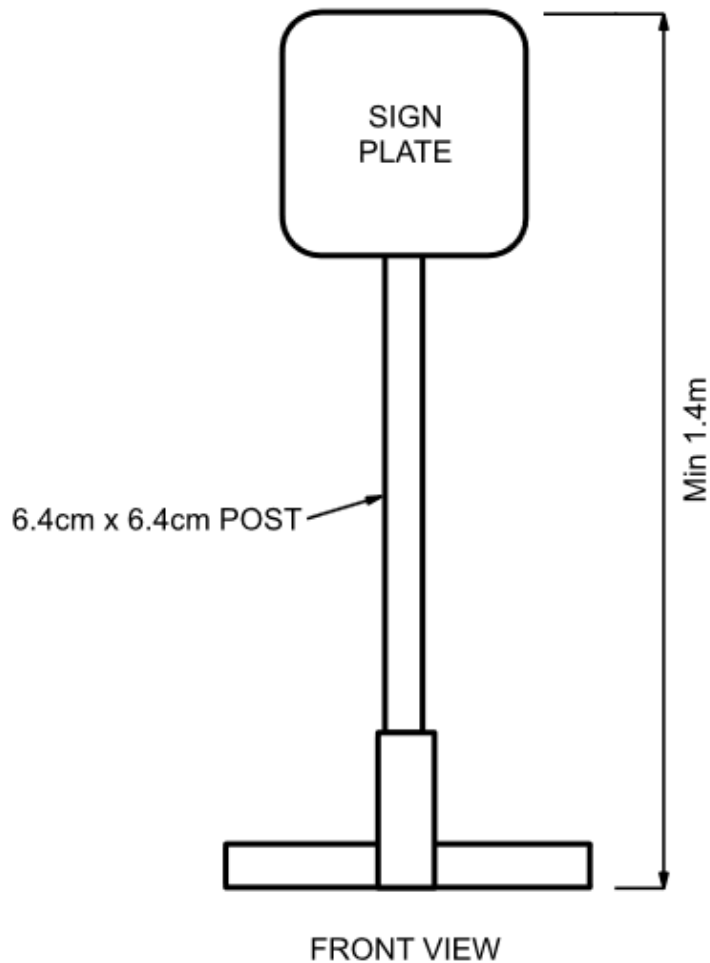

CONTROL OF TRAFFIC USING A TRAFFIC CONTROL PERSON

Traffic persons are required:

1. When two-way traffic has to be guided through a single lane
2. When materials or equipment are being moved across a sidewalk, multi-use path or travelled lane.
3. To assist pedestrians, cyclists and motorists through complicated traffic control set-ups.
4. When required by the Transportation Division.

Traffic control persons are responsible for the safety of motorists, cyclists, pedestrians, their fellow workers and equipment on the work site. Therefore, selecting a traffic control person must be based on the individuals experience, alertness and decisiveness. Traffic control persons shall be certified by an accredited agency and familiar with flagging standards and procedures.

A traffic control person is required to use a Stop/Slow paddle during the day. The paddle shall be reflectorized for night use. At night, a red lantern or flashlight must be used in addition to the paddle. A traffic control person must wear an approved hard hat, reflective safety vest and safety shoes as identified by the Saskatchewan Employment Act.

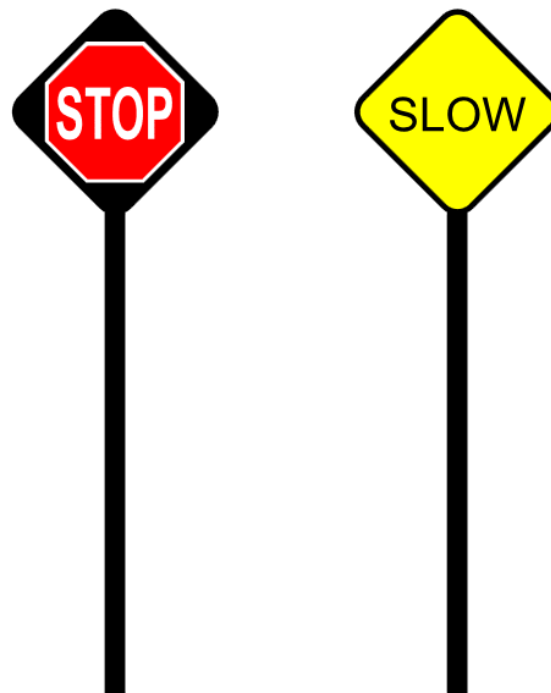

TC-65
450mm x 450mm

Illumination shall be provided for traffic control persons required to be working on or adjacent to City of Saskatoon roadways during hours of darkness. Always use a Traffic Control Person Ahead sign (TC-21) and a Be Prepared To Stop sign (TC-77) in advance to alert motorists of a flagging operation. Traffic control persons shall stop traffic from the side of the traffic lane and shall never turn their back to traffic. Traffic control persons shall never leave their post until relieved by another traffic control person in full safety apparel.

Each traffic control person shall keep in visual contact with any other traffic control persons on the job. If visual contact cannot be maintained, there must be radio contact or a third traffic control person to relay signals. For example, a third traffic control person can relay signals from a position on the middle of a curve, or atop a hill (where visibility is obstructed by horizontal or vertical curves.)

Where possible, traffic control persons shall co-ordinate direction of traffic flow with existing traffic signals. If co-ordination cannot be managed, contact Transportation Division a minimum of three working days prior to the flagging operation to arrange with the Traffic Operations to have the signals changed to an all-red flash mode.

When more than one traffic control person is required at an intersection, traffic shall be moved through the intersection one direction at a time. Use a predetermined clockwise or counter-clockwise rotation to accomplish this.

Certain situations may require the use of the Saskatoon Police Service (SPS). Contact the Transportation Division to discuss the need for police involvement. To arrange for pay duty officers, please contact the SPS at 306-975-2360 or special.events@police.saskatoon.sk.ca.

DELINEATION (CHANNELIZATION) DEVICES

Delineation devices are used to form curves, lines or boundaries that guide motorized road users, cyclists and pedestrians to the intended path.

Delineation devices along pedestrian routes shall:

1. Have continuous detectable edging at ground level for people with vision loss.
2. Be continuous, stable and rigid.
3. Be placed continuously without gaps between sections.

Delineation devices include cones, construction markers, drums, vertical panels, tubular devices and chevron alignment signs. Delineation devices do not include barricades, concrete barriers or signs other than chevron alignment signs.

Traffic cones shall be fluorescent orange and made of rubber or similar flexible material. The minimum height required for cones is 450mm on roadways with a speed limit of 50km/h or less, and 700mm for speeds up to 60km/h. For use on roadways where the speed is 70km/h or greater, 700mm cones shall be used for short-term closures and drums or tubular devices shall be used for long-term closures. Drums (or an equivalent) shall be used for all lane closure tapers on 60km/h or greater roadways or as specified by the Transportation Division. Tubular markers may be used for tangent sections on roadways (70km/h or greater) provided recommended spacing is adopted (refer to typical set-ups for required spacing).

Construction markers may be used for delineation devices; however, they are not recommended. Drums for high volume/speed roadways or cones for lower speed roadways are the preferred methods, as indicated above. Drums shall be constructed of a material that does not create a hazard to vehicles on impact and should be manufactured so as to not to roll.

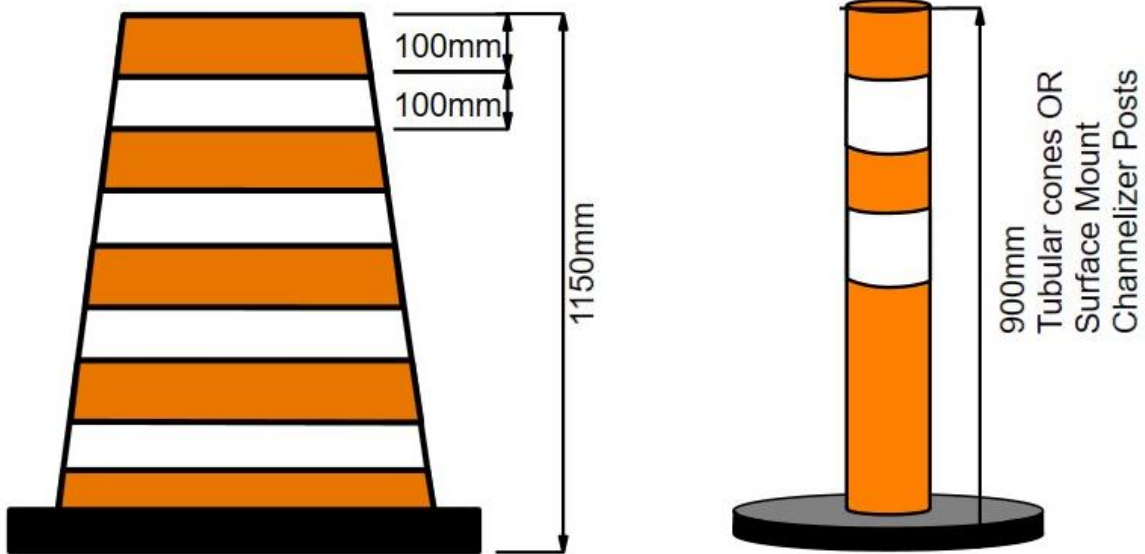
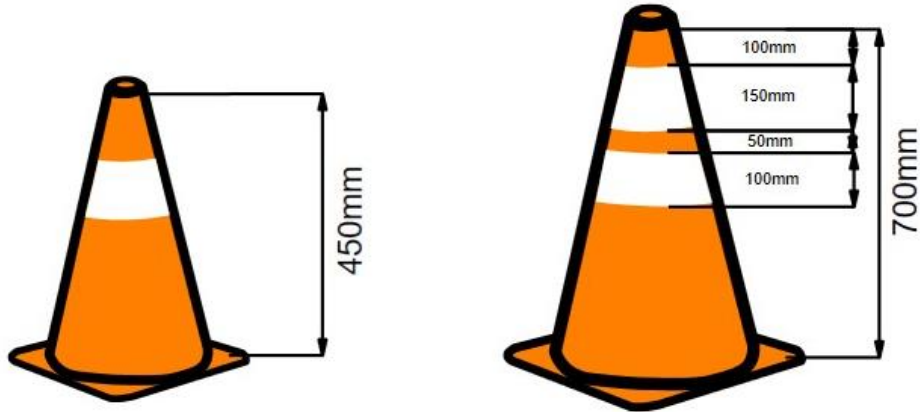

Chevron alignment signs may be used to provide additional guidance on the outside of curves or sharp turns.

Nighttime:

Amber flashers/warning lights shall be used to identify obstructions at night. There are three main types of lights for the purpose of temporary traffic control:

1. **Type A:** low intensity flashing lights for nighttime use.
2. **Type B:** high intensity flashers are effective day and night.
3. **Type C:** steady burn, low-wattage lights are used at night for delineation.

Additional consideration should be given for nighttime work. Nighttime work can expedite the work, reducing the disruption of traffic. If floodlights are used for nighttime work, care should be taken so as not to impair the vision of approaching motorists.

BARRICADES

Proper placement of barricades is necessary to ensure public safety. Barricades are a potential hazard. The following provides some examples of acceptable and non-acceptable use of barricades:

Barricades along pedestrian detour routes shall:

1. Have continuous detectable edging at ground level for people with vision loss
2. Be continuous, stable and rigid
3. Be placed continuously without gaps between sections.

Acceptable use of barricades:

1. Barricades shall face oncoming vehicular traffic
2. Barricades are used to outline hazardous work area and to prevent vehicles and pedestrians from entering the work area.
3. Barricades are used to warn of an activity area and to obstruct entry into an activity area.
4. The following signs may be placed on barricades; Men working Road Closed combo sign, Road Closed Ahead No Exit, Do Not Enter, Detour tab with Arrow and Must Turn Right/Left.
5. Barricades shall be used to close a road.

Non-acceptable use of barricades:

1. Barricades shall **not** be used as a delineation device.
2. Barricades shall **not** be placed parallel to the flow of traffic. (For example, they are not to be used to mark the boundary between a travel lane and the work area or separate adjacent lanes of traffic)
3. Barricades shall **not** be placed in oncoming traffic without necessary advance warning devices and signs.
4. Barricades shall **not** be used instead of signposts.
5. Barricades shall **not** be used for the placement of regulatory signs.
6. Barricades shall **not** be located within the buffer area.

Light barricades (as shown)

- A light barricade is a portable device that typically has one rail.
- Light barricades used along pedestrian routes must have detectable edging at ground level for people with vision loss. The edging can be provided in the form of a second rail at ground level.
- Light barricades used along pedestrian routes must be placed continuously without gaps between sections.
- Light barricades may be used for road, street, lane or shoulder closures of short duration.
- Light barricades should be stabilized using sandbags placed on the lower section of the frame. Under no circumstances shall they be placed over the rail of the barricade.

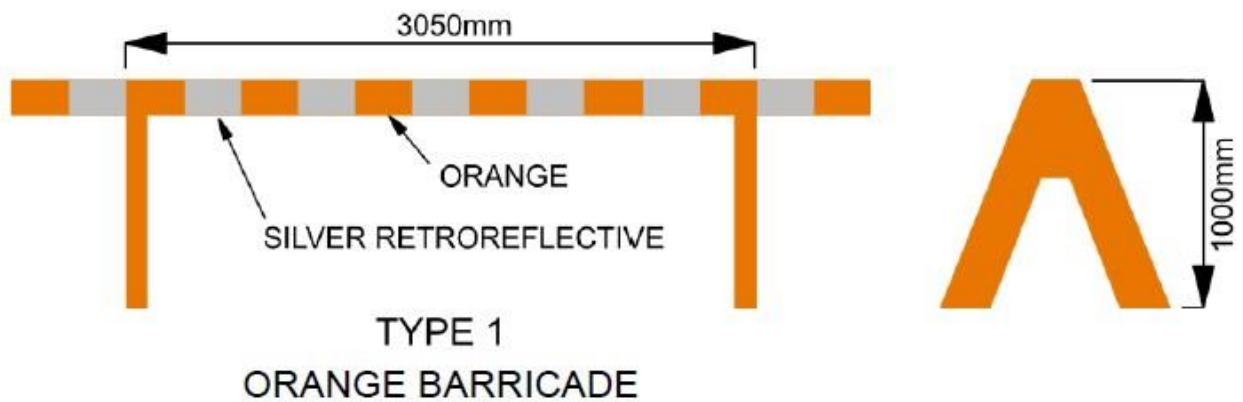



CONE BARS & PEDESTRIAN BARRICADES

Heavy barricades (as shown)

- A heavy barricade typically has three rails and is more permanent in nature as compared to a light barricade.
- Heavy barricades shall be used for road, street, lane or shoulder closures of long duration.
- Heavy barricades may be used for road closures of short duration.

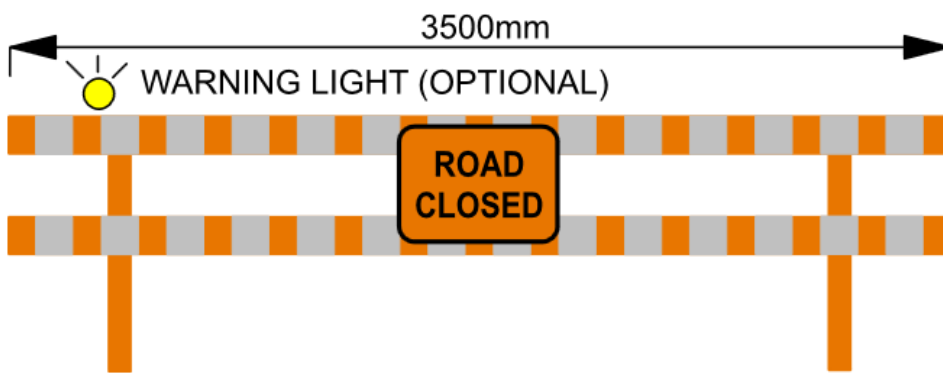

**TYPE 2
LARGE WOODEN BARRICADE**

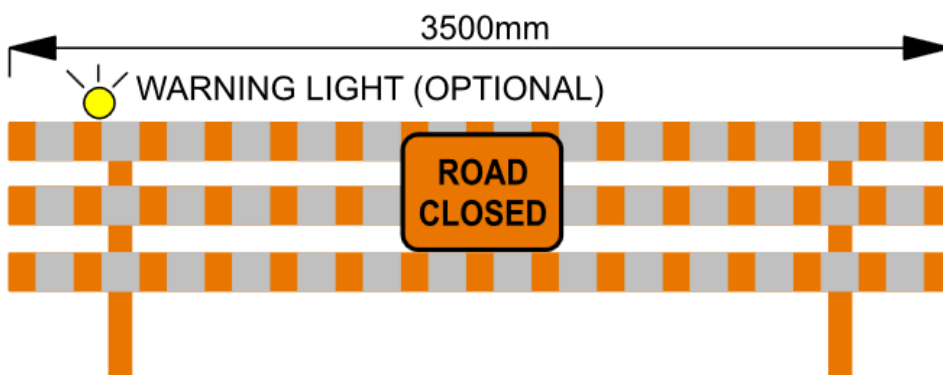
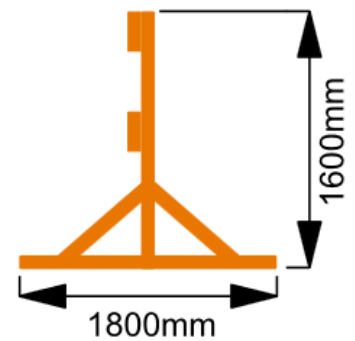

**TYPE 3
LARGE WOODEN BARRICADE**

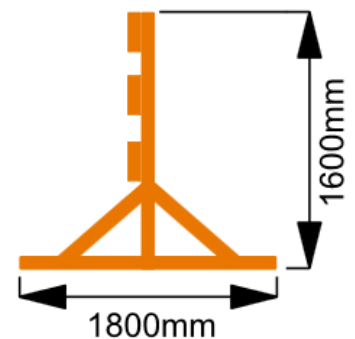

Wheelchair Ramps

- To be used for transitioning pedestrians / wheelchairs from sidewalk to road

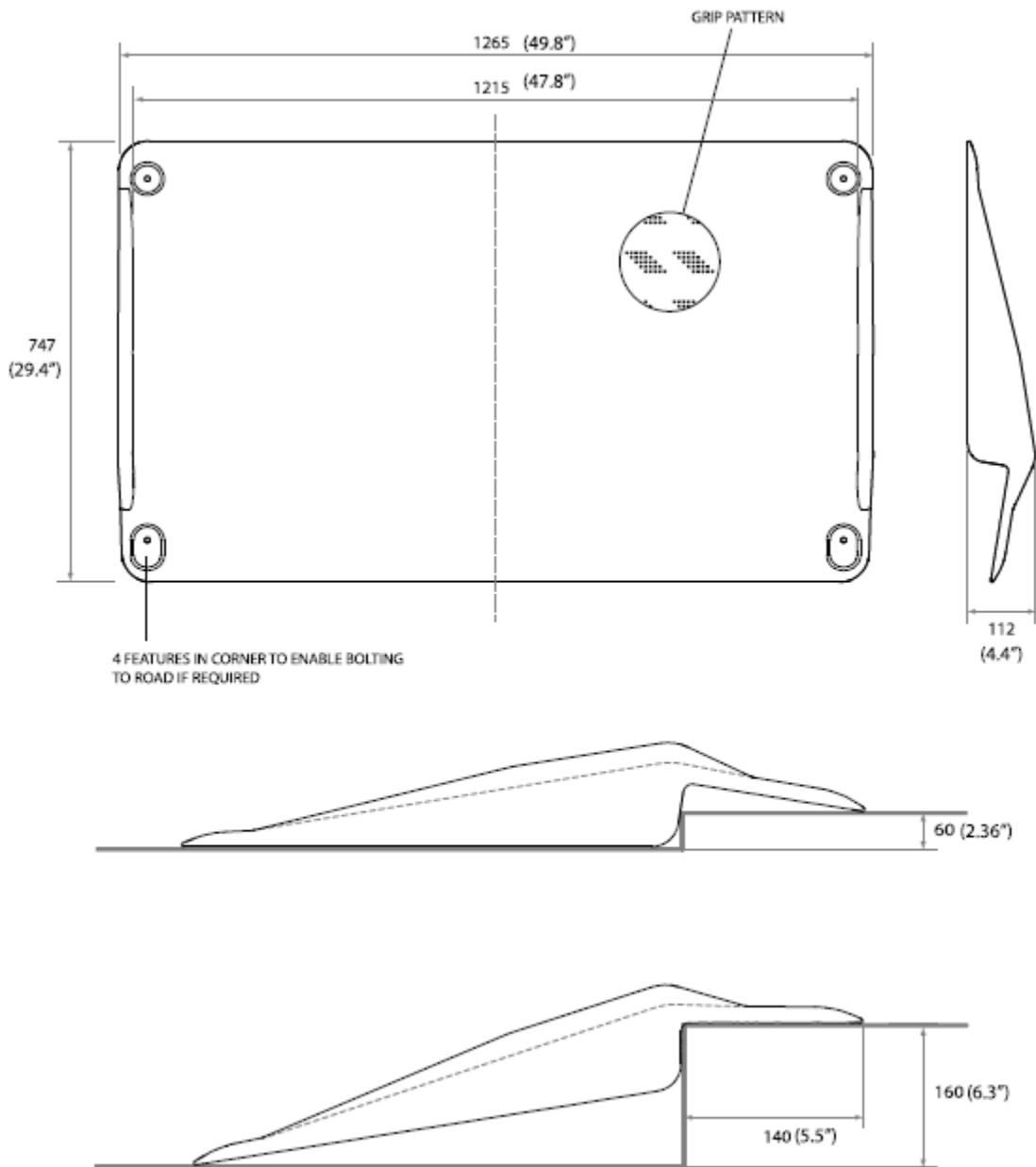

TRAFFIC BARRIERS

Longitudinal traffic barriers are used in work zones to:

- Limit the possibility of traffic entering the work area.
- Protect the workers.
- Separate traffic.
- Protect the construction site.
- Separate pedestrians from vehicular traffic.
- Protect Structures.

The use, placement and maintenance of longitudinal barriers should be based on acceptable engineering practices. Traffic barriers should:

- Be placed continuously without gaps between sections.
- Have Retro-Reflective tape or markings with a high reflectivity level attached along the face of the barrier (any side of the barrier that faces traffic or that traffic can see)
- Have acceptable flare rates on the leading edge or have appropriate end treatments (e.g., impact attenuators).
- Be equipped with glare screens where necessary.
- Be placed 0.6m from the edge of the driving lane.
- Be used during periods of inactivity where excavations compromise safety.

For acceptable applications and installation requirements, please contact the Transportation Division.

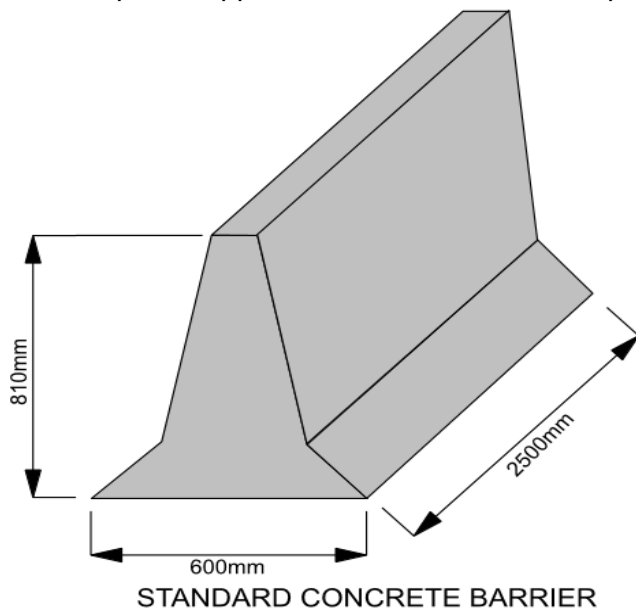

STEEL BARRIER



ARROW BOARDS

Arrow Boards are a safe and effective method of traffic control when used as intended. They are not to take the place of advance warning signs or delineation devices. When combined with the use of advance warning sign and delineation devices, arrow boards are very effective. They are especially useful in situations that require higher than normal visibility. Examples where arrow boards should be used are on overnight set-ups, high-speed, high-volume roadways and in poor weather conditions. It is important to note that arrow boards used for nighttime applications should be less bright than during daytime operations so as to not impair the vision of approaching motorists.

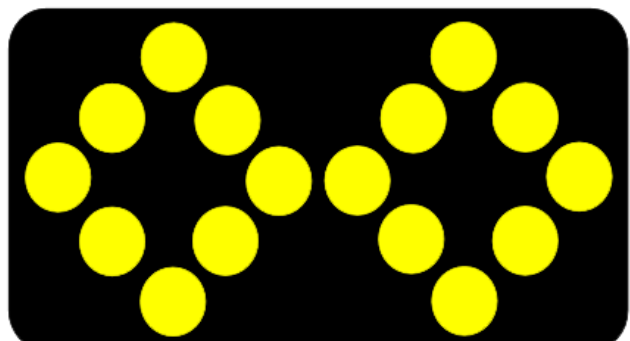
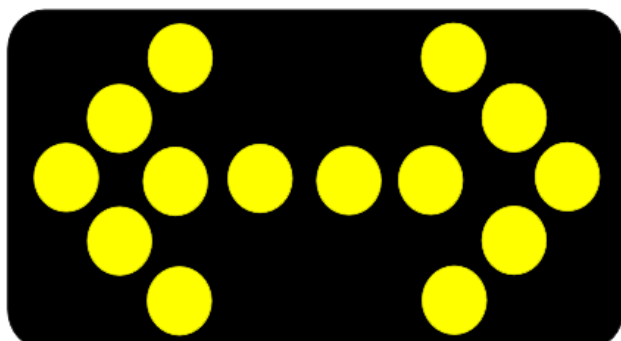
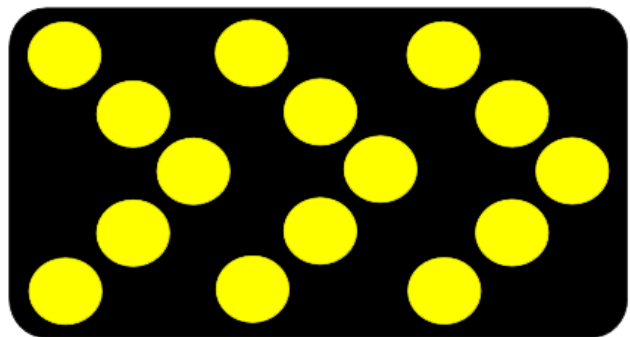
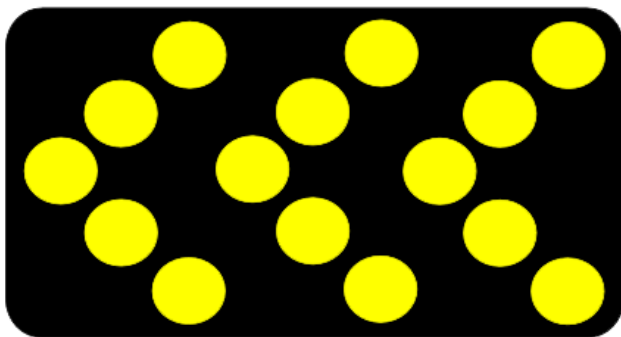

VARIABLE MESSAGE BOARDS

Variable message boards are used to relay information to motorists for upcoming or existing road construction. Typically, these are used on high-volume roadways where road construction is expected to cause delays and/or poor sightlines for motorists to be able to see the advance warning construction signs. For example, they are used to advise motorists to expect delays or use alternative routes where possible. They are also used to inform motorists of upcoming lane restrictions that may not be visible due to road configuration and sightlines. Examples of this are lane closures on Circle Dr between Warman Rd and Taylor St. Variable message boards must be placed before the various overpasses and curves in the road, and before the advance warning construction signs to help inform motorists of lane closures ahead (used as additional advance construction notice).

Variable message boards are more effective at capturing the attention of the road users than static signs. Variable message boards should be programmed so motorists are able to read the message twice given the posted speed.

IMPACT ATTENUATORS

Impact Attenuators (also known as crash cushions) are used to prevent an errant vehicle from impacting a fixed object by controlled deceleration. Impact attenuators in temporary traffic control zones protect the motorists from the exposed ends of barriers, fixed objects and other hazards. There are two types of attenuators commonly used for temporary traffic control: (1) stationary, and (2) truck mounted (or mobile). Truck mounted attenuators (TMAs) are mounted on the rear of a crash truck and deform on impact in a controlled manner.

Stationary attenuators are recommended for long-term situations, while TMAs are preferable for short-term or mobile operations.

END CONSTRUCTION SIGNAGE

End Construction signage shall be used when:

- A speed reduction has been used for the closure.
- A closure that does not have a continuous line of sight.
- A construction site is not entirely visible from any given location.
- A long-term closure is being used.

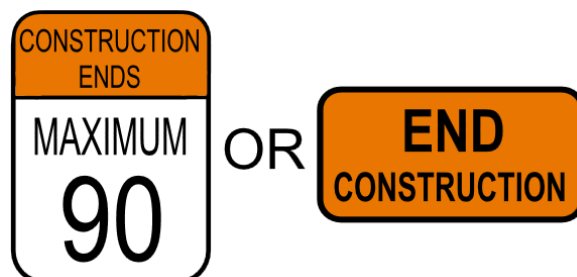

CHAPTER 5 – TEMPORARY TRAFFIC CONTROL (TYPICAL APPLICATIONS)

This chapter deals with how signs and devices are used for temporary traffic conditions. Since they cannot cover all site-specific conditions, the examples provided here are labelled as typical applications. These typical applications provide the user with the minimum requirements for temporary traffic control. Signs and devices must be placed outside of the pedestrian and bicycle routes, such as sidewalks and multi-use pathways.

Please refer to the Drawing Index on page 39 for various examples of temporary traffic control applications.

DRAWING INDEX

1. Roadside work	40
2. Work adjacent to a roadway.....	42
3. Shoulder work.....	44
4. Work on edge of roadway	46
5. Two-way flagging operation	48
6. Yield to oncoming traffic.....	50
7. Single right lane closure.....	52
8. Single left lane closure.....	54
9. Speed Reduction with Right Lane Closed.....	56
10. Multi-lane closure two right lanes.....	58
11. Multi-lane closure two left lanes	60
12. Multi-lane closure left lane closed in each direction	62
13. Centre line cross-over two-way traffic	64
14. Median cross-over two-way traffic.....	66
15. Intersection work example 1	68
16. Intersection work example 2	70
17. Intersection work example 3	72
18. Intersection work example 4	74
19. Intersection work example 5	76
20. Intersection work example 6	78
21. Back lane closures.....	80
22. Road closure.....	82
23. Local Road One-Way closure	84
24. Local Road Speed Reduction (Max 30km/h).....	86
25. Road diversion two directions	88
26. Shoulder detour	90
27. Sidewalk closures	92
28. Mobile – Shoulder work	104
29. Mobile – Encroachment in Lane.....	106
30. Mobile – Lane Closure	108
31. Very short – Encroachment in lane.....	110
32. Road bridging.....	112
33. Zipper merge.....	114
34. Ramp closure.....	116
35. Ramp entrance lane closure	118
36. Ramp exit lane closure.....	120
37. Bike lane closure.....	122

1 – ROADSIDE WORK

1. EXAMPLE SHOWN

Two-lane – two-way street without shoulder

No encroachment onto road.

2. CONDITIONS

Worksite must be in the boulevard area, completely off the road.

Excavations require protection (refer to Chapter 3; securing the worksite)

3. OBSERVATIONS

Note use of advance warning sign

4. SET-UP PROCEDURE

Set-up advance warning signs and then cones.

Commence work.

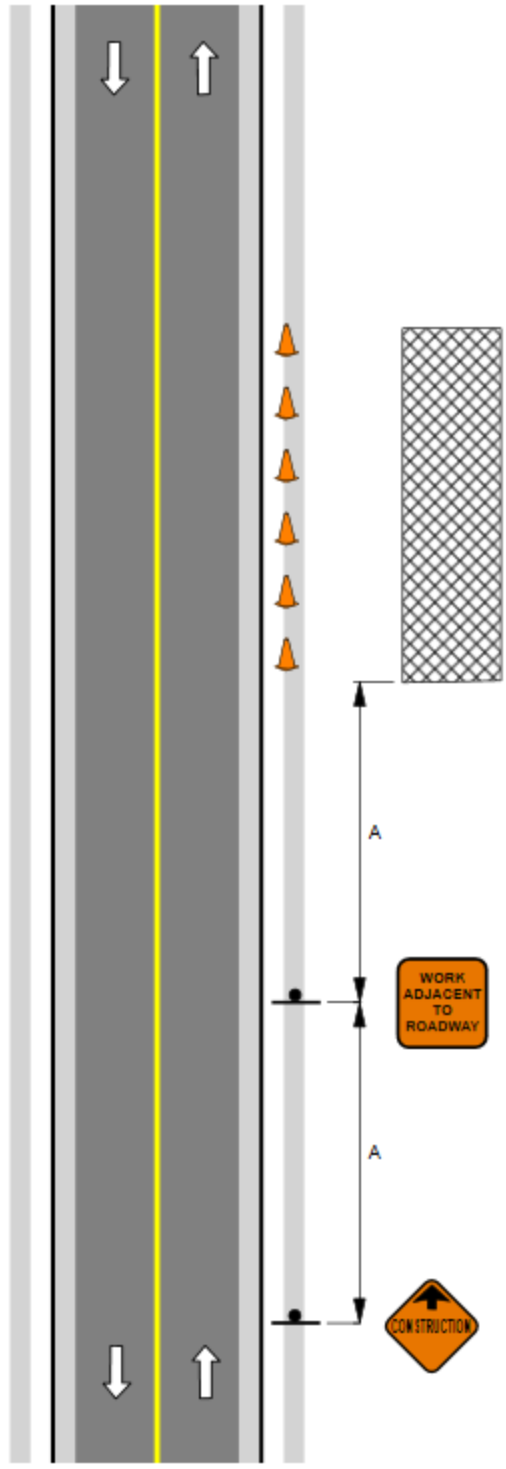

NOTE:
This drawing is a graphical
representation of the detour setup.
It is NOT drawn to scale.

GUIDELINE 1 FOR LANE CLOSURE TAPER 1 AND LONGITUDINAL BUFFER SPACE					
V(km/h)	A(m)	L(m)	B(m)	D(m)	
50	50	30	35	8	
60	50	40	45	12	
70	75	60	50	15	
80	100	80	60	15	
90	100	105	65	18	
100	125	125	70	18	

Where:
V = Posted Speed Limit
A = Spacing between Signs
L = Length of Taper
B = Length of Longitudinal Buffer Space
D = Spacing between Delineation Devices

1. ROADSIDE WORK

2 – WORK ADJACENT TO A ROADWAY

1. EXAMPLE SHOWN

Two-lane – two-way street without shoulder

No encroachment onto road.

2. CONDITIONS

Worksite must be in the boulevard area, completely off the road.

Excavations require protection (refer to Chapter 3; securing the worksite)

3. OBSERVATIONS

Note use of advance warning sign

4. SET-UP PROCEDURE

Set-up advance warning signs and then cones.

Commence work.

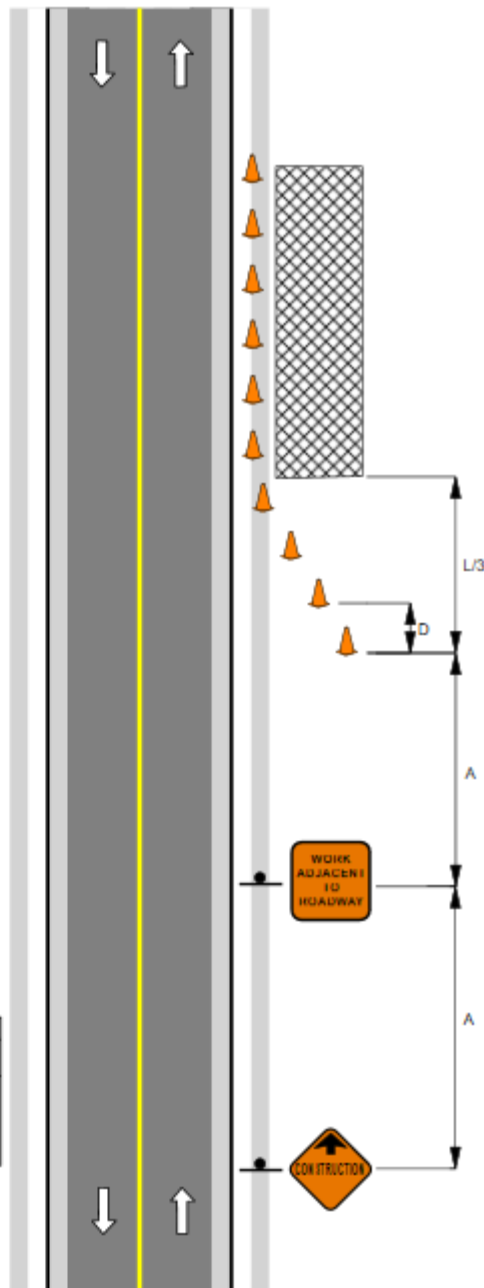

NOTE:
This drawing is a graphical
representation of the detour setup.
It is NOT drawn to scale.

GUIDELINES FOR LANE CLOSURE TAPERS AND LONGITUDINAL BUFFER SPACE					
V(kmh)	A(m)	L(m)	B(m)	D(m)	
50	50	30	35	8	SHORT TERM
60	50	40	45	12	SHORT TERM
70	75	60	50	15	SHORT TERM
80	100	80	60	15	LONG TERM
90	100	105	65	18	LONG TERM
100	125	125	70	18	LONG TERM

Where:
V = Posted Speed Limit
A = Spacing between Signs
L = Length of Taper
B = Length of Longitudinal Buffer Space
D = Spacing between Delineation Devices

2. WORK ADJACENT TO A ROADWAY

3 – SHOULDER WORK

1. EXAMPLE SHOWN

Two-lane – two-way street with parking lane/shoulder

No encroachment in lane.

2. CONDITIONS

Approaching traffic must be able to pass by worksite while remaining completely within their lane.

3. OBSERVATIONS

Applies to sidewalk and gutter repairs

4. SET-UP PROCEDURE

Set-up advance warning sign.

Set-up Lane Closure Arrow Sign.

Set-up taper and outline worksite with cones.

Commence work.

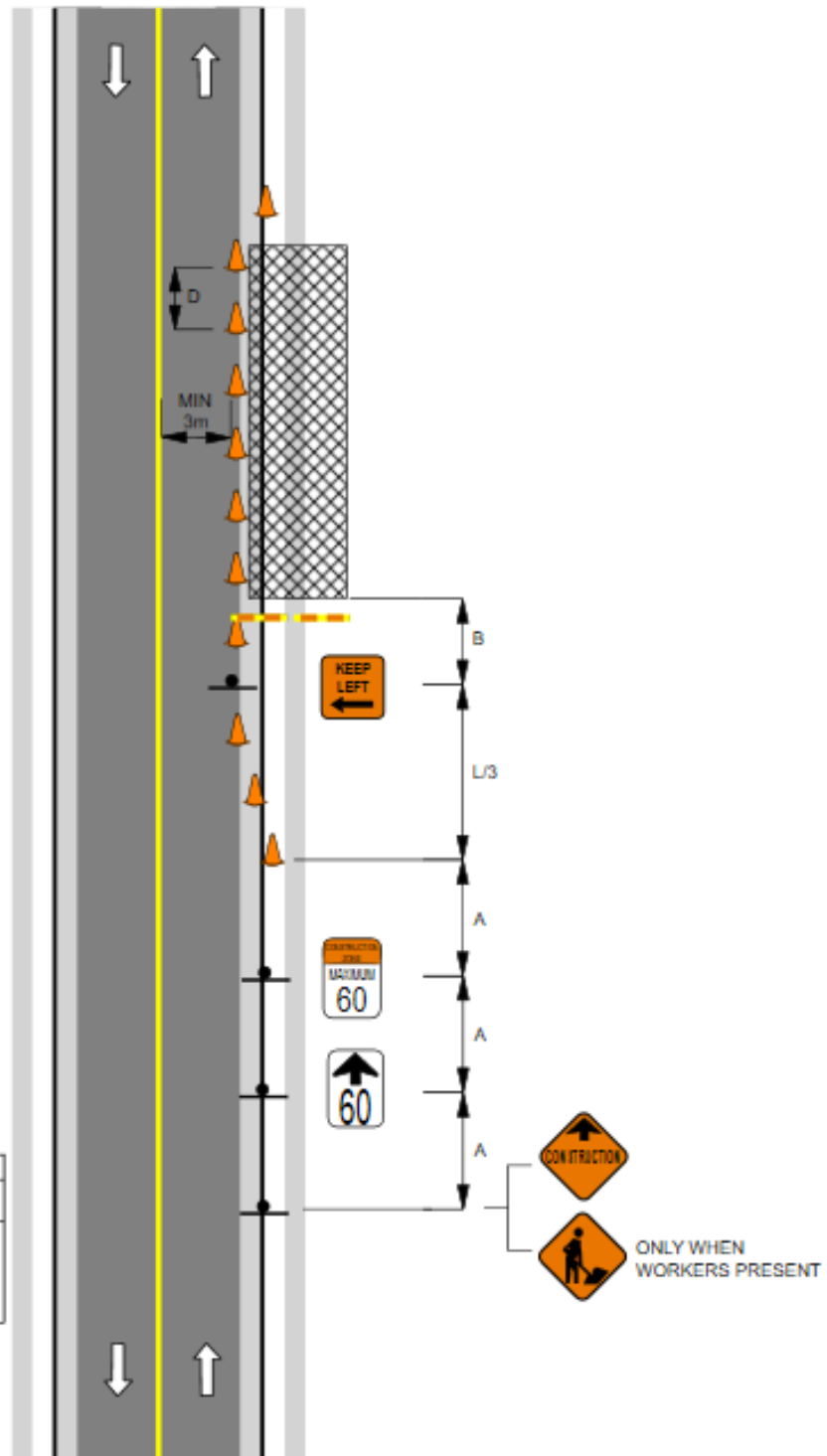

NOTE:
This drawing is a graphical representation of the detour setup. It is NOT drawn to scale.

GUIDELINES FOR LANE CLOSURE TAPERS AND LONGITUDINAL BUFFER SPACE					
V(kmh)	A(m)	L(m)	B(m)	D(m)	
50	50	30	35	8	
80	50	40	45	12	
70	75	60	50	15	
80	100	80	60	15	
90	100	105	65	18	
100	125	125	70	18	

Where:
V = Posted Speed Limit
A = Spacing between Signs
L = Length of Taper
B = Length of Longitudinal Buffer Space
D = Spacing between Delineation Devices

3. SHOULDER WORK

4 – WORK ON EDGE OF ROADWAY

1. EXAMPLE SHOWN

Two-lane – two-way street parking lane.

Encroachment in right lane.

2. CONDITIONS

Approaching traffic must be diverted into oncoming traffic.

3. OBSERVATIONS

Two lanes of 3m minimum width must be available (bus routes require more width). If this condition cannot be met, refer to two-way flagging operation.

4. SET-UP PROCEDURE

Set-up No Parking zone first by the City of Saskatoon 36 hours prior to restriction.

Start at top of diagram. Set-up advance warning signs for southbound lane in order shown.

Set-up cones and two-way traffic signs separating the two lanes.

Start at the bottom of the diagram. Set-up right northbound lane in order shown.

Outline worksite with cones.

Commence work.

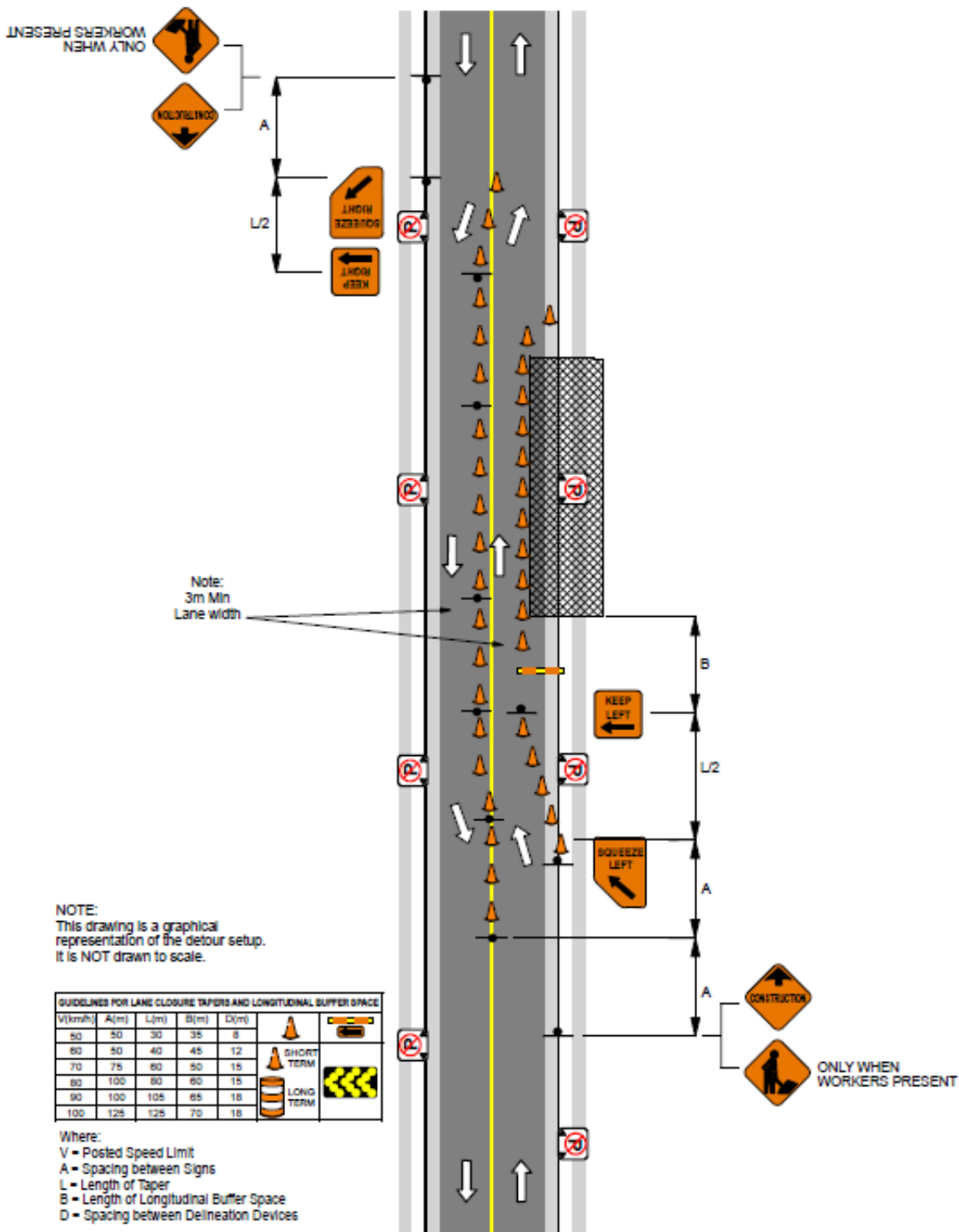

4. WORK ON EDGE OF ROADWAY

5 – TWO-WAY FLAGGING OPERATION

1. EXAMPLE SHOWN

Two-lane – two-way street.

2. CONDITIONS

One lane of traffic will be completely blocked. May extend worksite into second lane, provided enough space for traffic to drive by worksite (min 3m).

3. OBSERVATIONS

For speeds in excess of 50km/h, a speed reduction set-up is required.

Flagger on upper left of diagram must stop traffic far enough back to allow oncoming traffic access to northbound lane.

Recommend installing No Parking zones on both sides of the road.

4. SET-UP PROCEDURE

Set-up No Parking zone first by the City of Saskatoon 36 hours prior to restriction.

Set-up advance warning signs on both sides in order shown.
Post traffic control persons.

Set-up taper and outline worksite with cones.

Commence work.

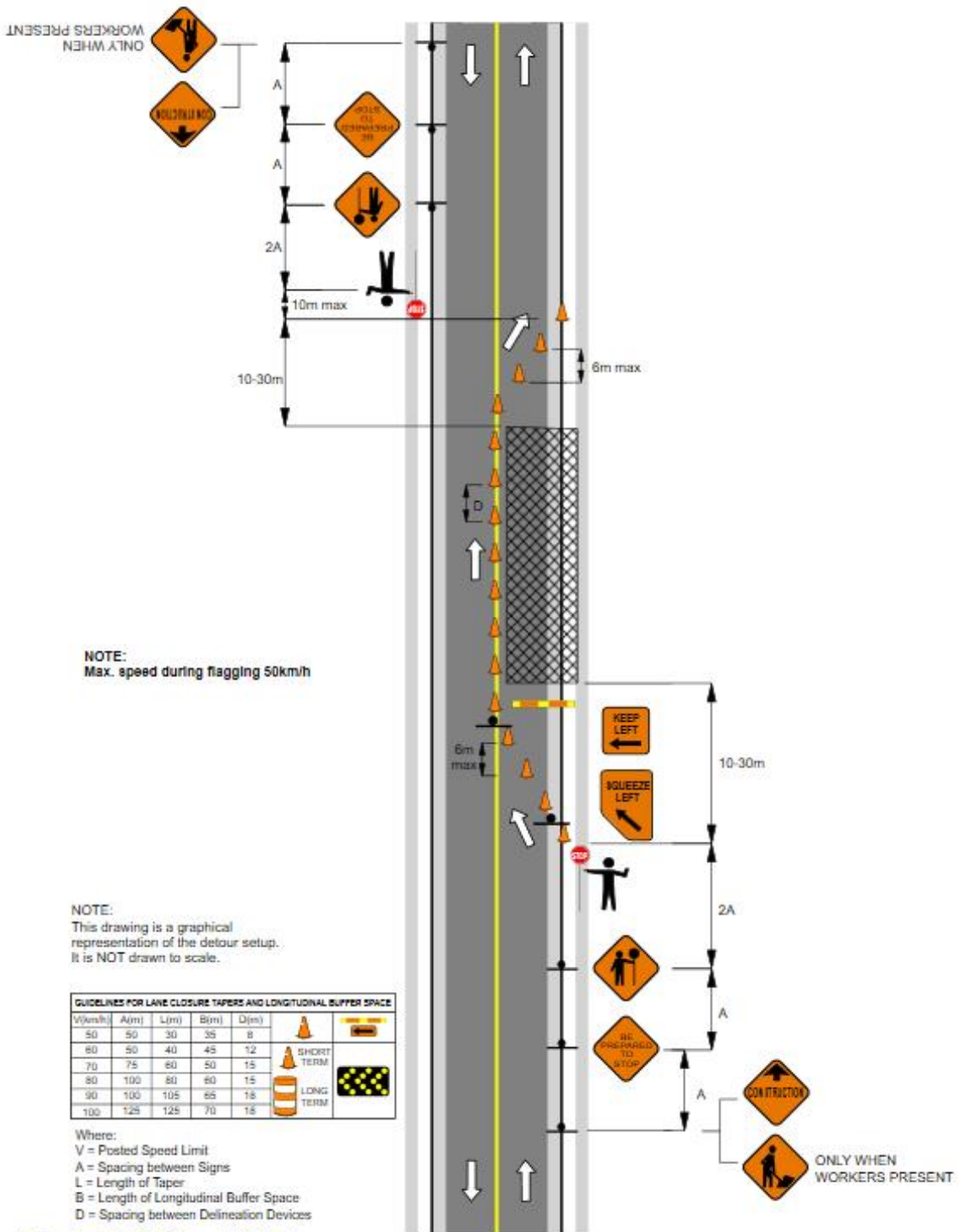

5. TWO-WAY FLAGGING OPERATION

6 – YIELD TO ONCOMING TRAFFIC

1. EXAMPLE SHOWN

Two-lane – two-way street.

2. CONDITIONS

Single lane closure.

Entire zone must be visible from both directions

Residential Street – low volume roads only.

3. OBSERVATIONS

Used for securing a worksite during periods of inactivity. During working hours, refer to two-way flagging operation.

Overnight set-up requires use of flashers. (Refer to Chapter 4; Delineation (Channelization) devices for flasher use.)

4. SET-UP PROCEDURE

Set-up No Parking zone first by the City of Saskatoon 36 hours prior to restriction.

Start at top of diagram. Set-up advance warning sign for the southbound lane.

Start at bottom of diagram. Set-up advance warning signs in order shown. Set-up taper and outline worksite with cones.

Commence work.

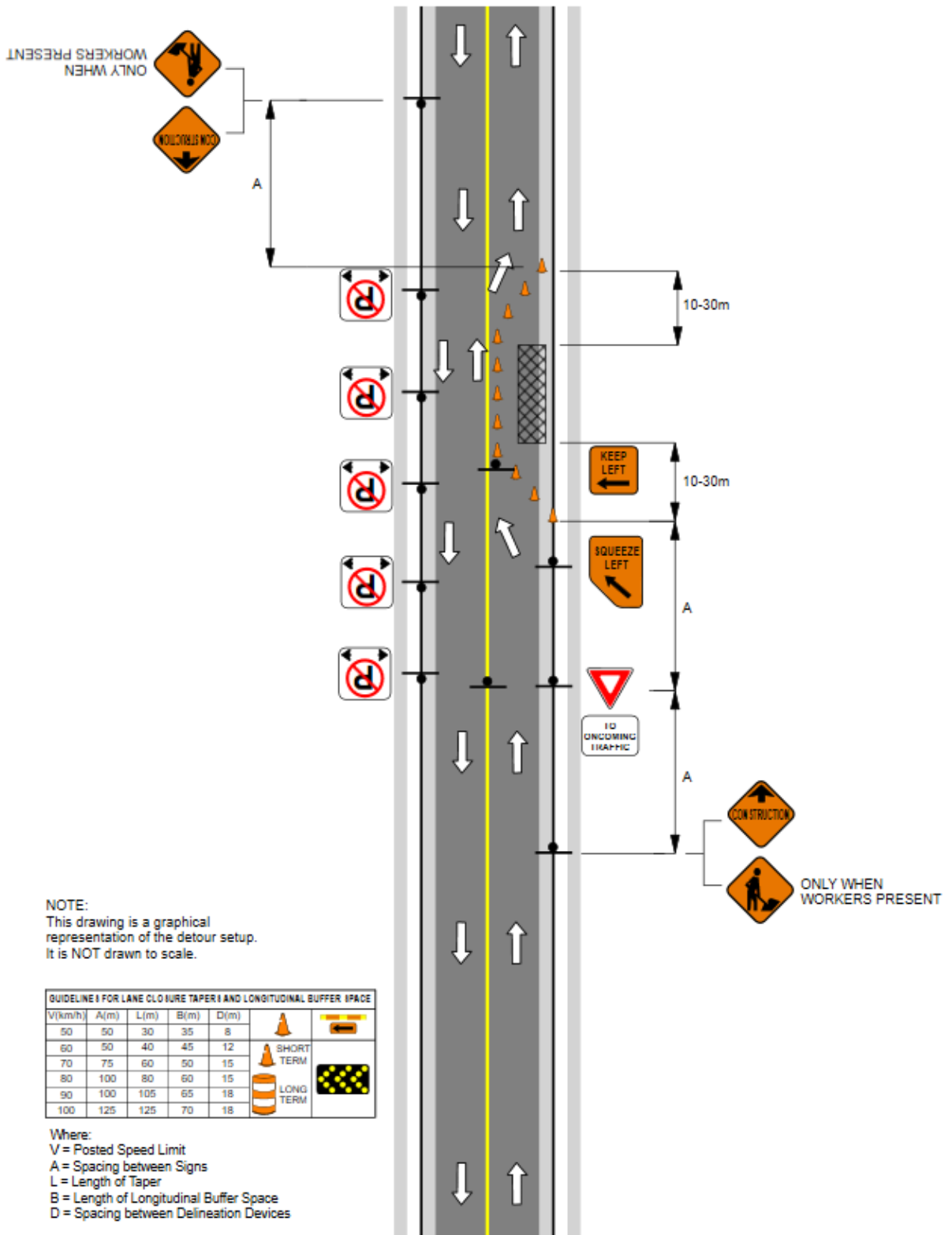

7 – SINGLE RIGHT LANE CLOSURE

1. EXAMPLE SHOWN

Two-way – four-lane street

2. CONDITIONS

Single lane closure.

3. OBSERVATIONS

Note Right Lane Closed and Squeeze Left signs to allow more reaction time for motorists to change lanes. Two Right Lane Closed signs can be used as well.

4. SET-UP PROCEDURE

Start at bottom of diagram. Set-up advance warning signs in order shown.

Set-up taper and outline worksite with cones.

Commence work.

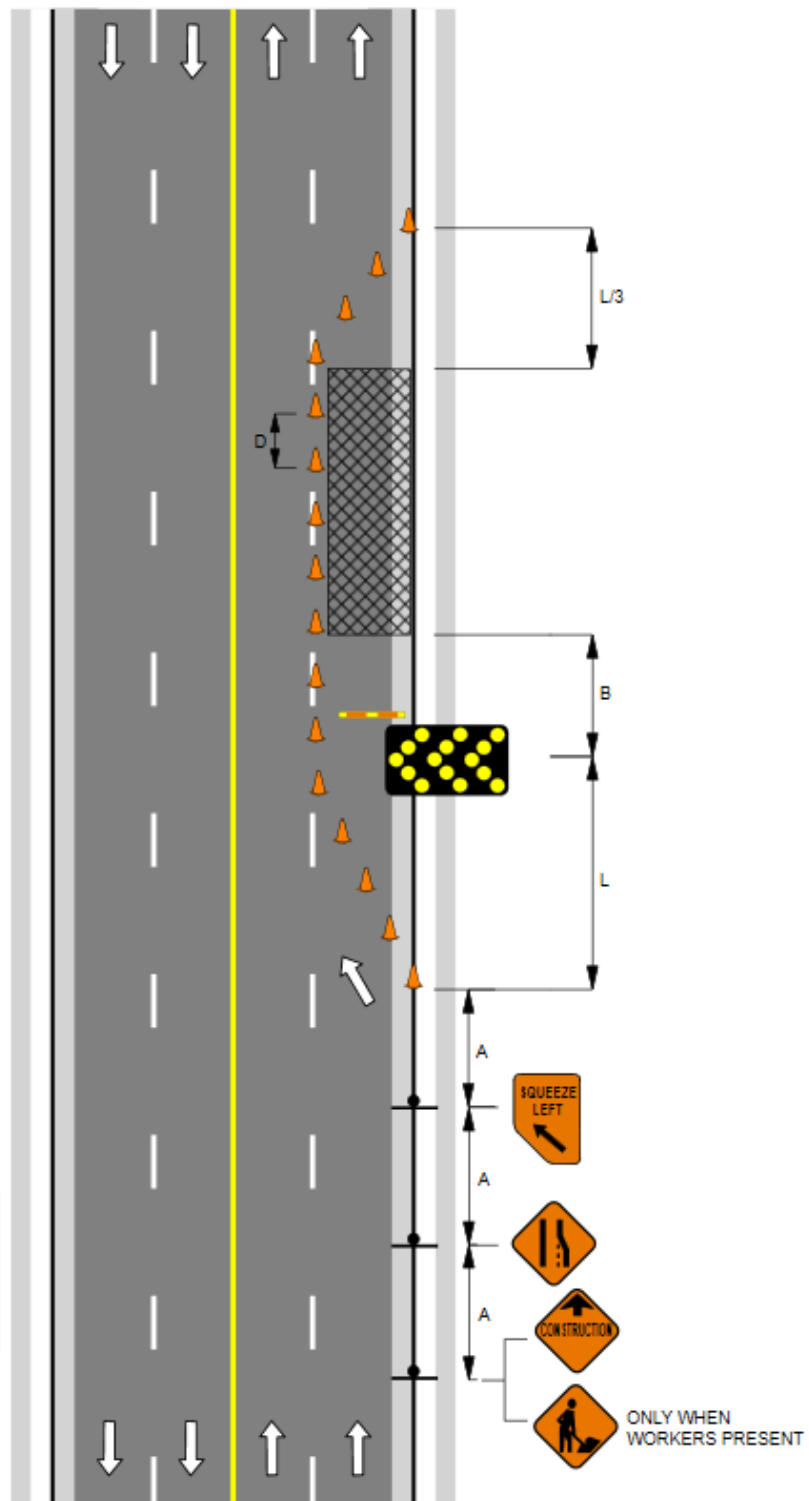

NOTE:
This drawing is a graphical representation of the detour setup. It is NOT drawn to scale.

GUIDELINE 1 FOR LANE CLOSURE TAPER AND LONGITUDINAL BUFFER SPACE					
V(km/h)	A(m)	L(m)	B(m)	D(m)	
50	50	30	35	8	SHORT TERM
60	50	40	45	12	
70	75	60	50	15	LONG TERM
80	100	80	60	15	
90	100	105	65	18	
100	125	125	70	18	

Where:
V = Posted Speed Limit
A = Spacing between Signs
L = Length of Taper
B = Length of Longitudinal Buffer Space
D = Spacing between Delineation Devices

7. SINGLE RIGHT LANE CLOSURE

8 – SINGLE LEFT LANE CLOSURE

1. EXAMPLE SHOWN

Two-way – four-lane street

2. CONDITIONS

Single lane closure.

3. OBSERVATIONS

Note signing on centre line of road.

Rectangular “text” lane closure signs may be used where conditions do not allow for diamond-shaped signs.

4. SET-UP PROCEDURE

Start at bottom of diagram. Set-up advance warning signs in order shown.

Set-up taper and outline worksite with cones. Set-up sign at top of diagram.

Commence work.

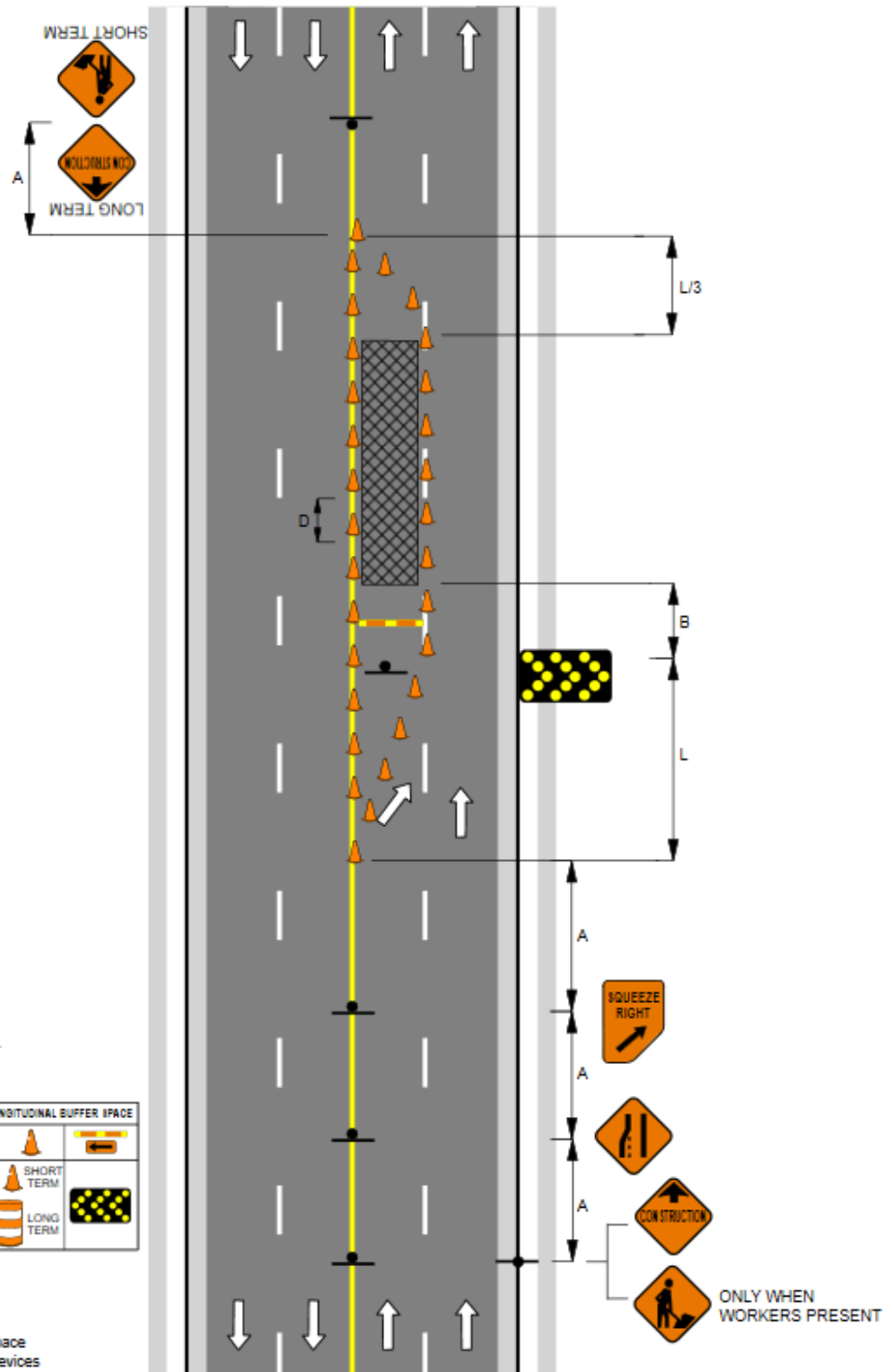

8. SINGLE LEFT LANE CLOSURE

9 – SPEED REDUCTION WITH RIGHT LANE CLOSURE

1. EXAMPLE SHOWN

Divided two-way – four-lane street

2. CONDITIONS

Closure of right lane.

3. OBSERVATIONS

Note Construction Ahead, 60 Ahead and Maximum 60 are used on both sides of the roadway.

4. SET-UP PROCEDURE

Start at bottom of diagram.

Set-up advance warning signs in order shown.

Set-up taper and outline worksite with cones.

Commence work.

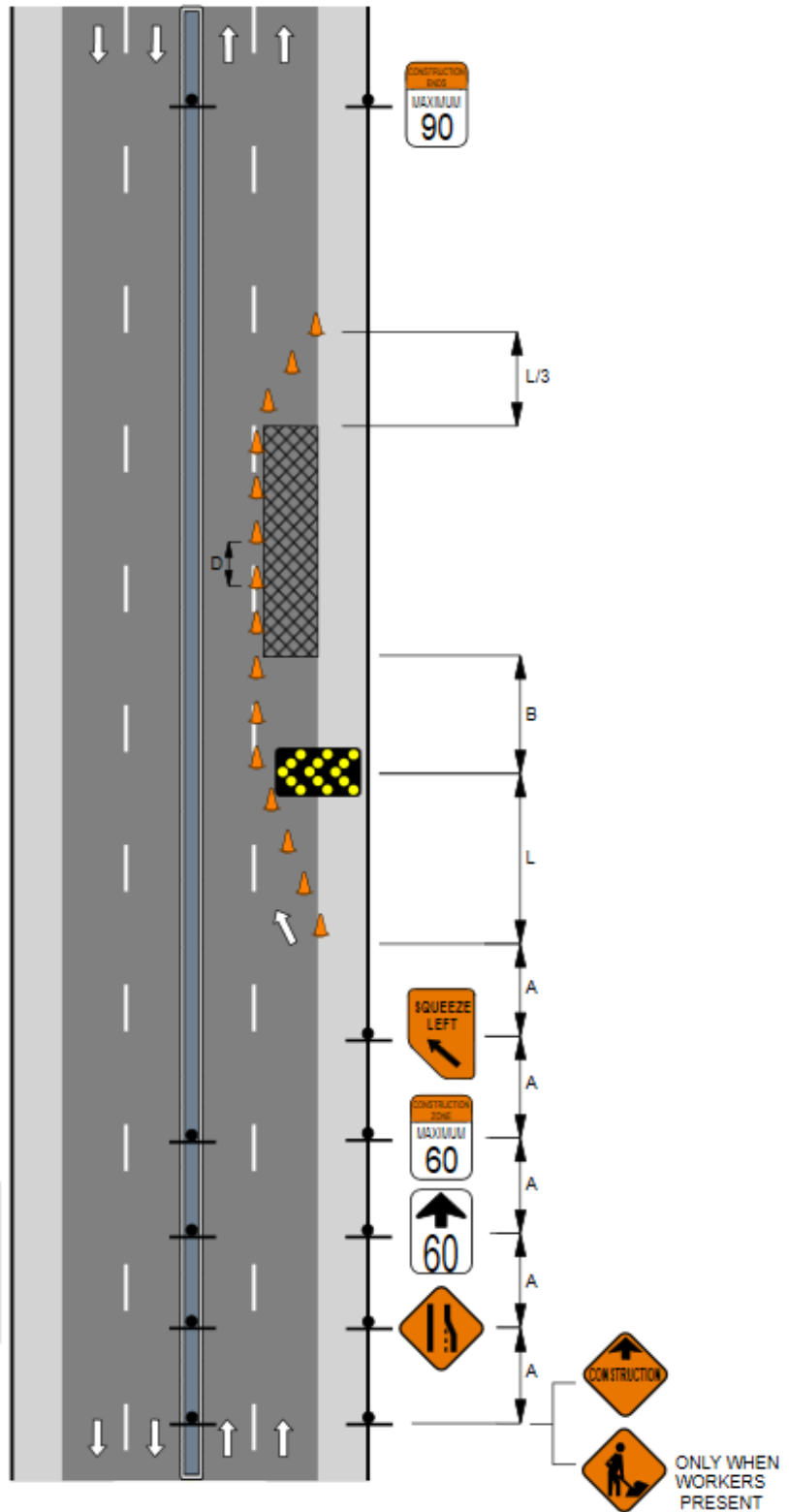

NOTE:
This drawing is a graphical representation of the detour setup. It is NOT drawn to scale.

GUIDELINE 1 FOR LANE CLOSURE TAPER 1 AND LONGITUDINAL BUFFER SPACE					
V(km/h)	A(m)	L(m)	B(m)	D(m)	
50	50	30	35	8	SHORT TERM
60	50	40	45	12	SHORT TERM
70	75	60	50	15	SHORT TERM
80	100	80	60	15	LONG TERM
90	100	105	65	18	LONG TERM
100	125	125	70	18	LONG TERM

Where:
V = Posted Speed Limit
A = Spacing between Signs
L = Length of Taper
B = Length of Longitudinal Buffer Space
D = Spacing between Delineation Devices

9. SPEED REDUCTION WITH RIGHT LANE CLOSURE

10 – MULTI-LANE CLOSURE TWO RIGHT LANES

1. EXAMPLE SHOWN

Three-lane – one-way street

2. CONDITIONS

Two lane closure

3. OBSERVATIONS

Each lane must be closed separately and a straight section (tangent) provided between tapers.

Note use of arrow boards.

4. SET-UP PROCEDURE

Start at bottom of diagram.

Set-up double-lane closure in order shown. Work towards top of diagram.

Outline worksite with cones.

Commence work.

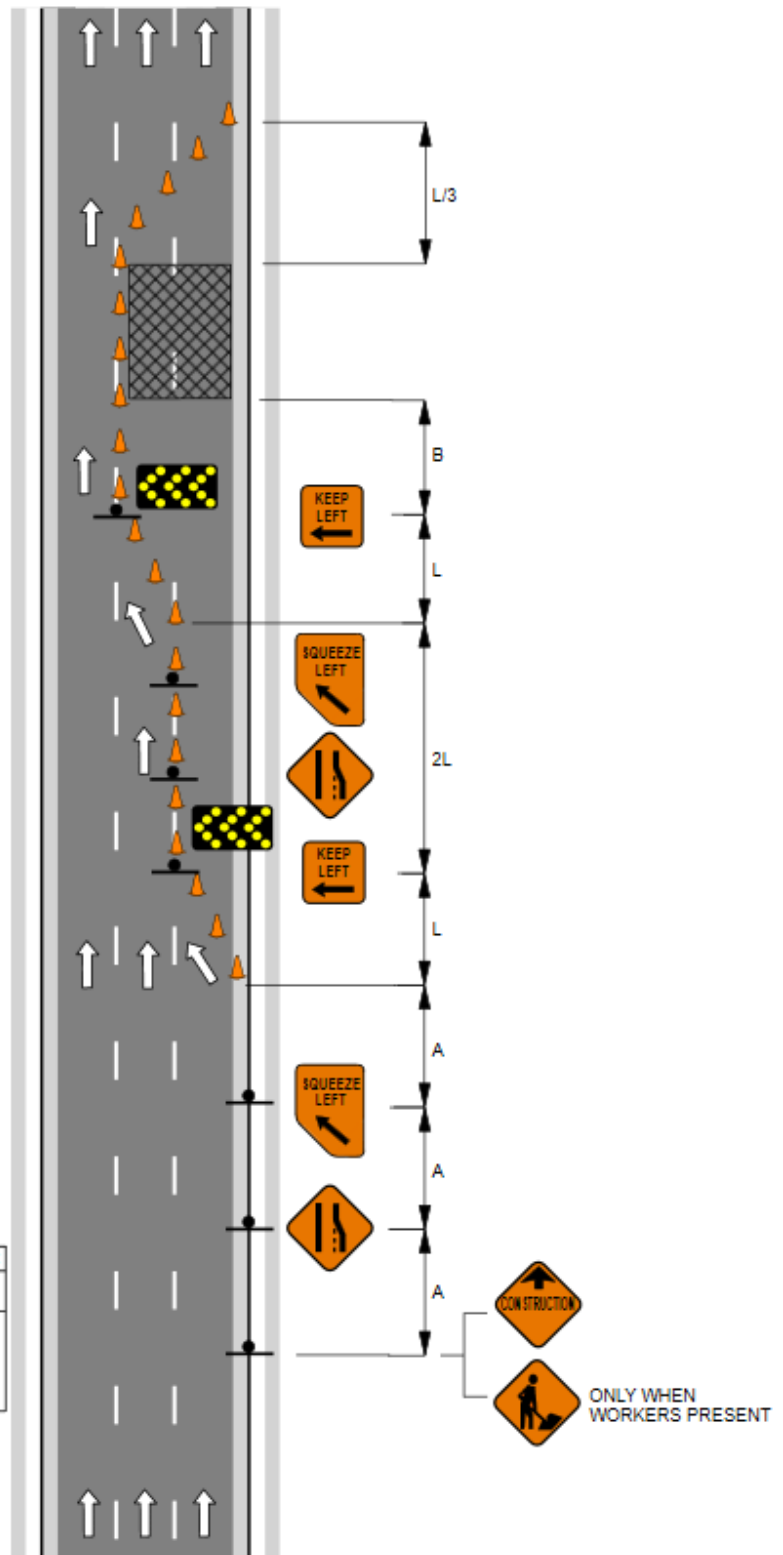

NOTE:
This drawing is a graphical representation of the detour setup. It is NOT drawn to scale.

GUIDELINE 1 FOR LANE CLOSURE TAPER AND LONGITUDINAL BUFFER SPACE					
V(kmh)	A(m)	L(m)	B(m)	D(m)	
50	50	30	35	8	SHORT TERM
60	50	40	45	12	
70	75	60	50	15	LONG TERM
80	100	80	60	15	
90	100	105	65	18	
100	125	125	70	18	

Where:
V = Posted Speed Limit
A = Spacing between Signs
L = Length of Taper
B = Length of Longitudinal Buffer Space
D = Spacing between Delineation Devices

10. MULTI-LANE CLOSURE TWO RIGHT LANES

11 – MULTI-LANE CLOSURE TWO LEFT LANES

1. EXAMPLE SHOWN

Three-lane – one-way street

2. CONDITIONS

Two lane closure

3. OBSERVATIONS

Each lane must be closed separately and a straight section (tangent) provided between tapers.

Note use of arrow boards.

4. SET-UP PROCEDURE

Start at bottom of diagram.

Set-up double-lane closure in order shown. Work towards top of diagram.

Outline worksite with cones.

Commence work.

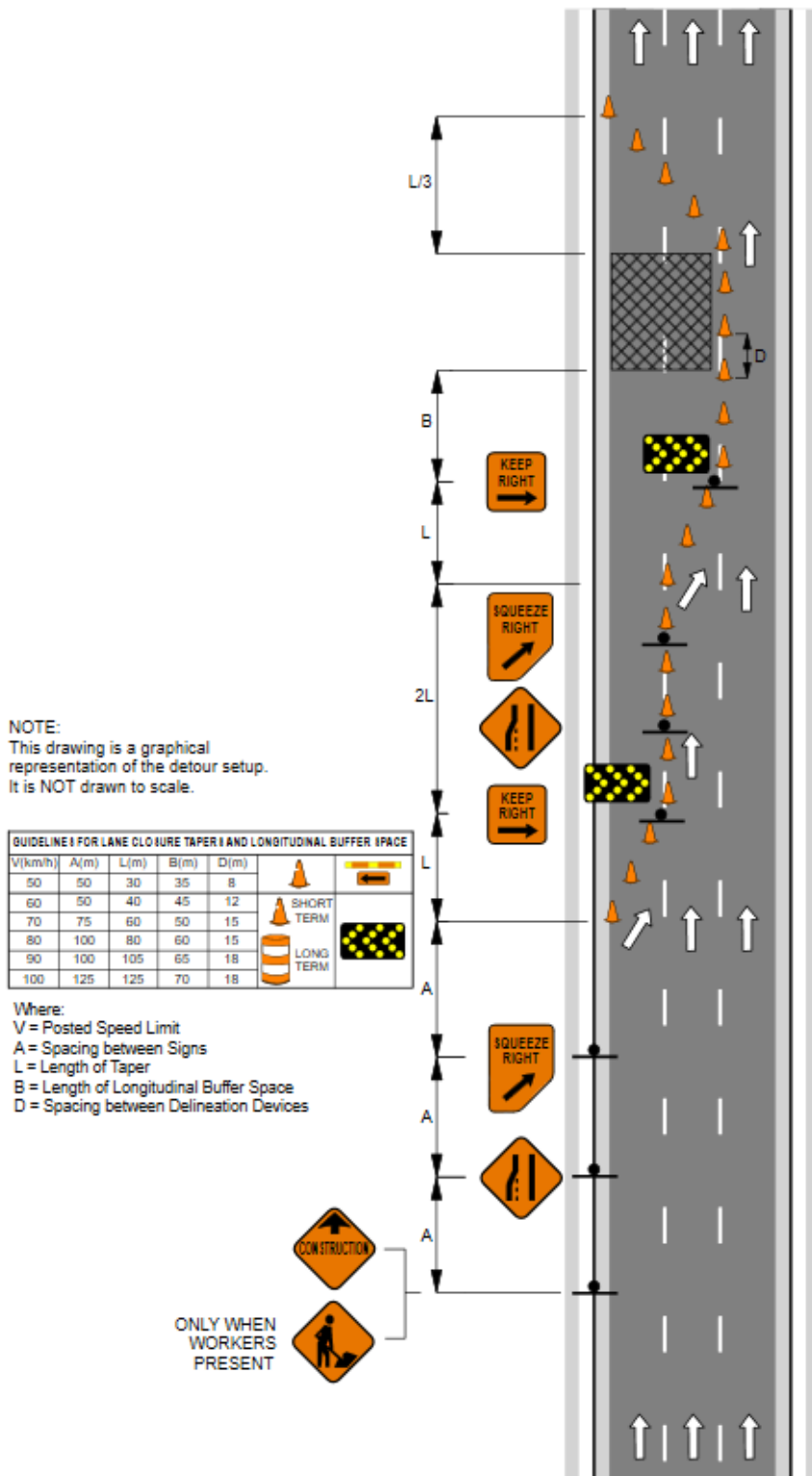

11. MULTI-LANE CLOSURE TWO LEFT LANES

12 – MULTI-LANE CLOSURE LEFT LANE CLOSURE IN EACH DIRECTION

1. EXAMPLE SHOWN

Four-lane – two-way street

2. CONDITIONS

Set-up two single-lane closure, one in each direction

3. OBSERVATIONS

Use traffic control persons to protect workers during set-up

Rectangular “text” lane closure signs may be used where conditions do not allow for diamond shaped signs.

4. SET-UP PROCEDURE

Set-up advance warning signs from top and bottom of diagram in order shown.

Set-up tapers and outline work area with cones.

Commence work.

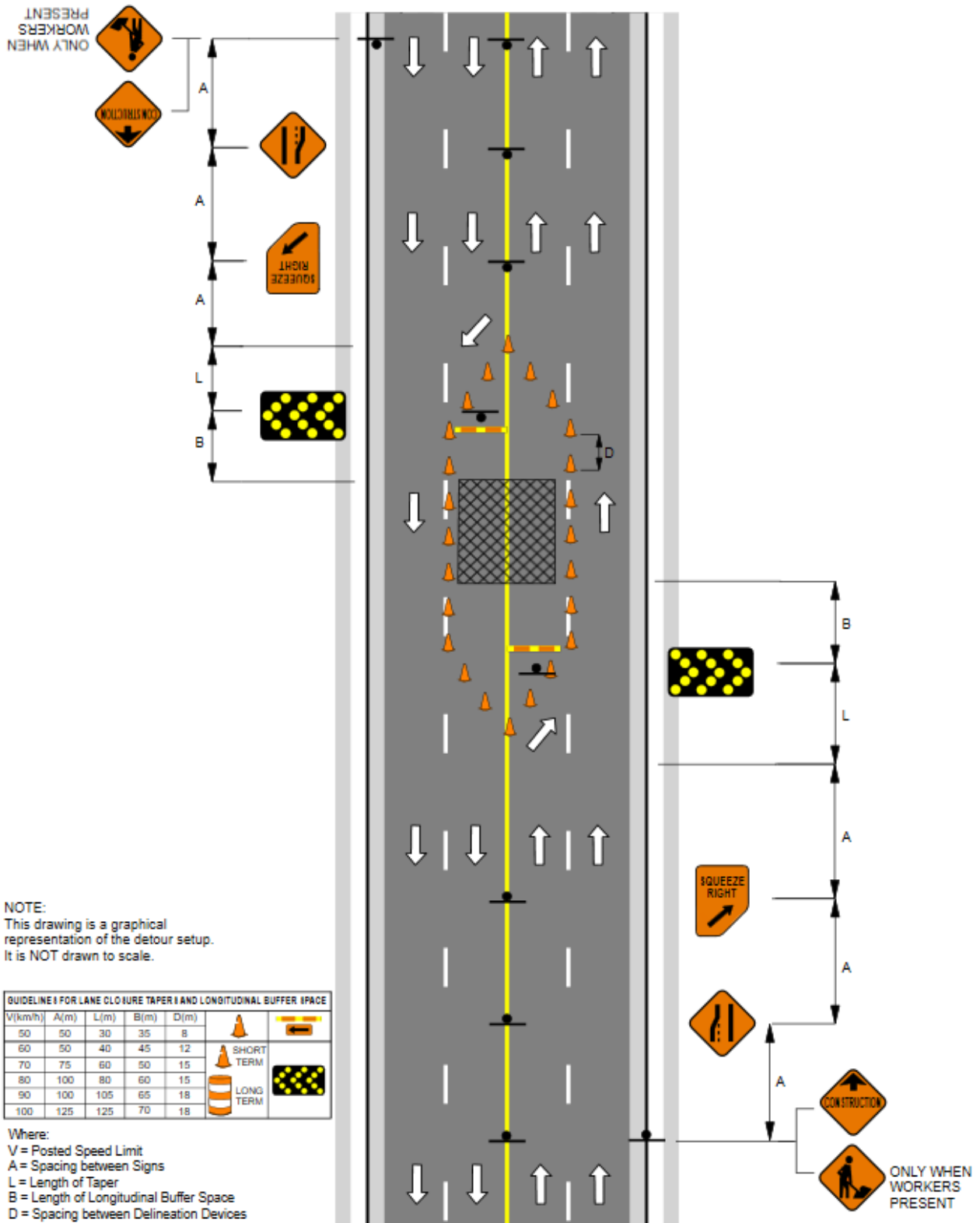

12. MULTI-LANE CLOSURE LEFT LANE CLOSED IN EACH DIRECTION

13 – CENTRE LINE CROSSOVER TWO-WAY TRAFFIC

1. EXAMPLE SHOWN

Four-lane – two-way street

2. CONDITIONS

Two-lane closure in one direction.

Single-lane closure in the other direction.

3. OBSERVATIONS

Rectangular “text” lane closure signs may be used where conditions do not allow for diamond shaped signs.

Placement of two-way traffic signs

4. SET-UP PROCEDURE

Southbound traffic must be diverted first. Start at top of diagram. Set-up single –lane closure, two tapers, barricade and two-way traffic signs in order shown.

Traffic on right side may now be diverted into oncoming traffic lane. Start at bottom right of diagram.

Set-up double-lane closure in order shown. Outline work area with cones.

Commence work.

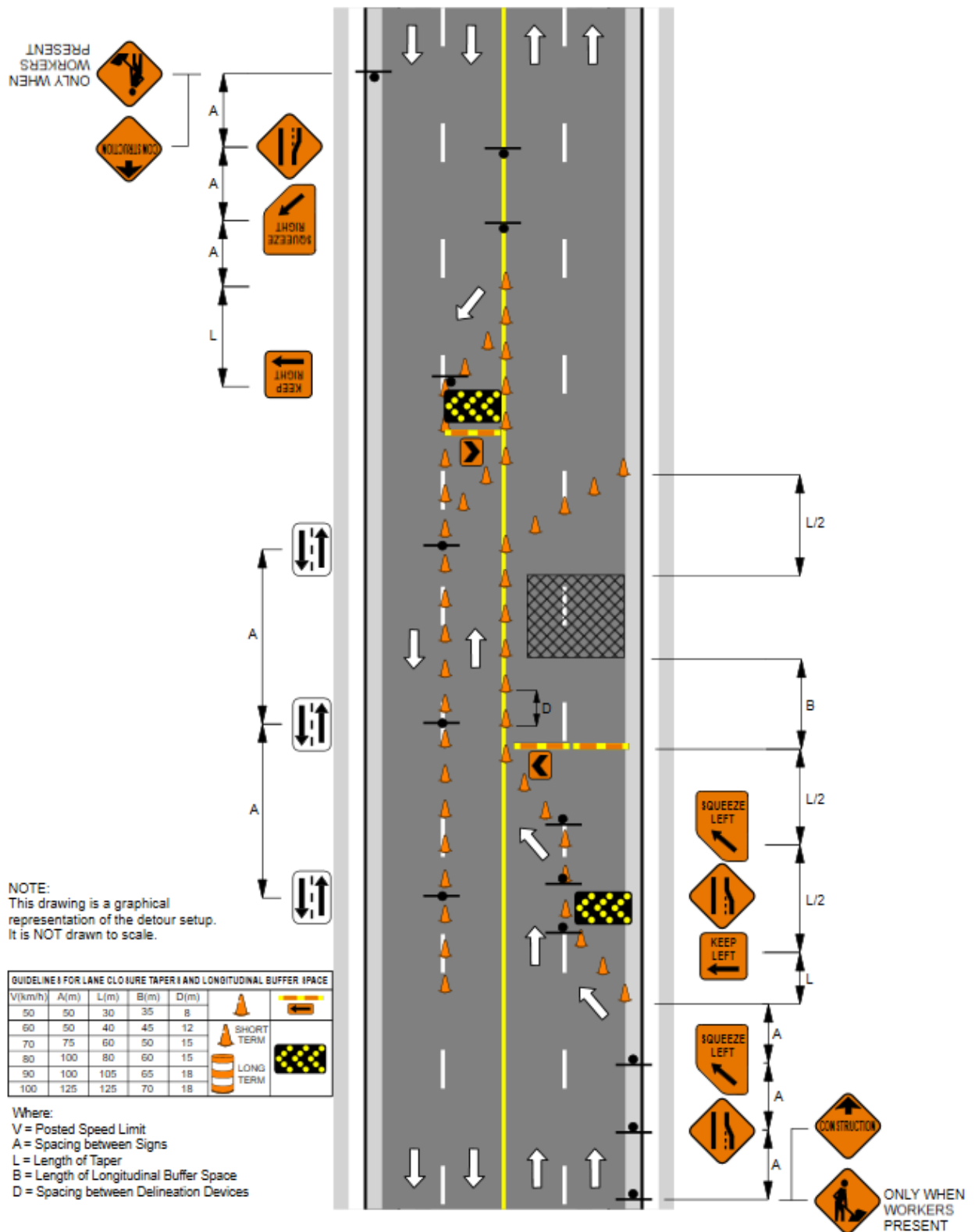

13. CENTRE LINE CROSSOVER TWO-WAY TRAFFIC

14 – MEDIAN CROSSOVER TWO-WAY TRAFFIC

1. EXAMPLE SHOWN

Divided two-way, four-lane street.

2. CONDITIONS

One lane of traffic must cross median.

Arrangement made prior for curb crossing.

3. OBSERVATIONS

Removal of median may be required, or curbs may need to be treated with asphalt to allow crossover.

Note use of arrow board.

Speed reduction may be required.

4. SET-UP PROCEDURE

Traffic on left side must be diverted first. Start at top of diagram. Set-up single-lane closure, two tapers, barricade and two-way traffic signs in order shown.

Traffic on right side may now be diverted into oncoming traffic lane. Start at bottom right of diagram. Set-up double-lane closure in order shown. Outline worksite with cones.

Commence work.

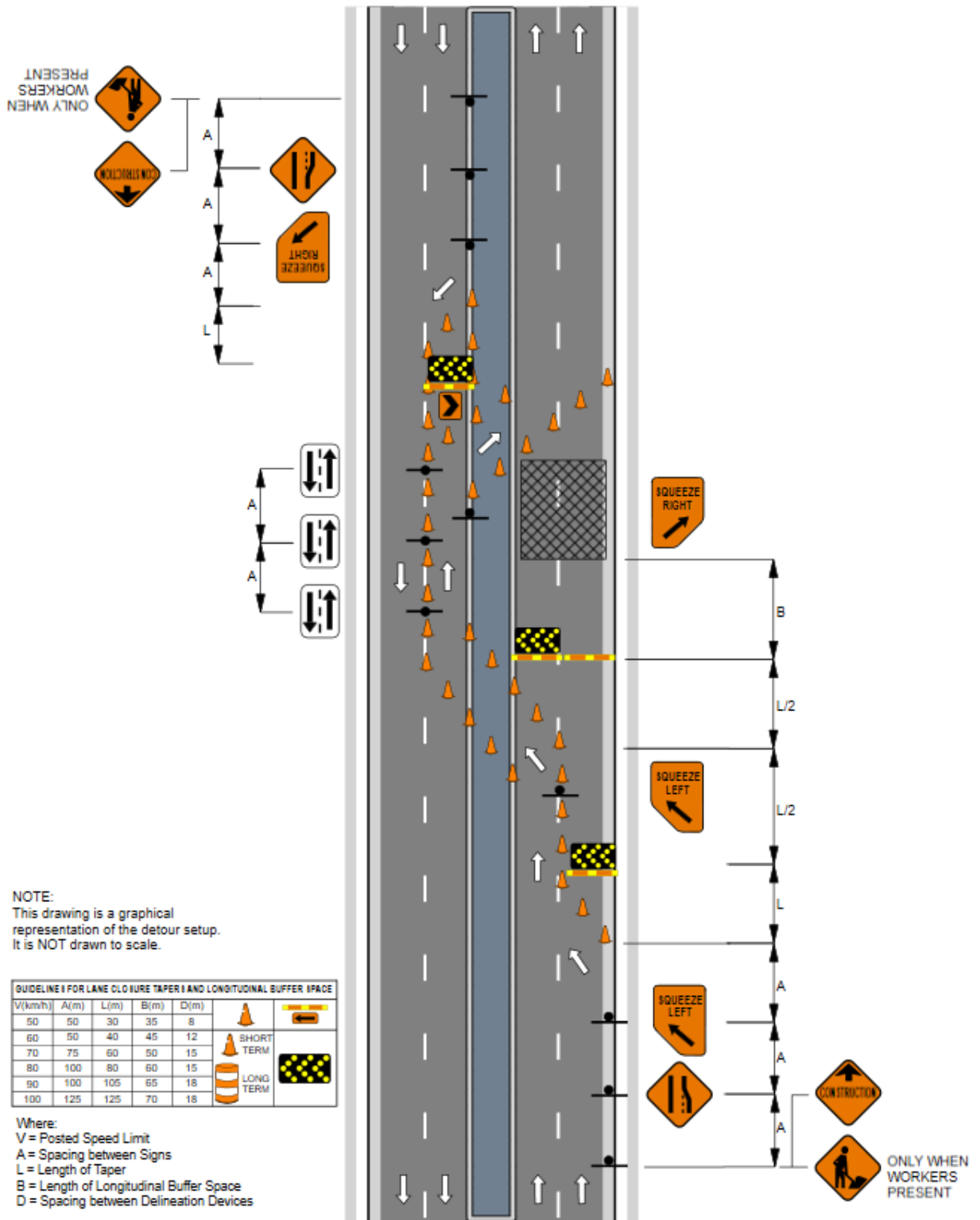

14. MEDIAN CROSSOVER TWO-WAY TRAFFIC

15 – INTERSECTION WORK – EXAMPLE 1

1. EXAMPLE SHOWN

Two-lane – four-legged intersection.

2. CONDITIONS

Require a portion of each lane in each direction.

3. OBSERVATIONS

Use traffic control persons to protect workers during set-up.

4. SET-UP PROCEDURE

Set up all Construction Ahead signs first.

Outline worksite with cones and Lane Closure Arrows signs.

Commence work.

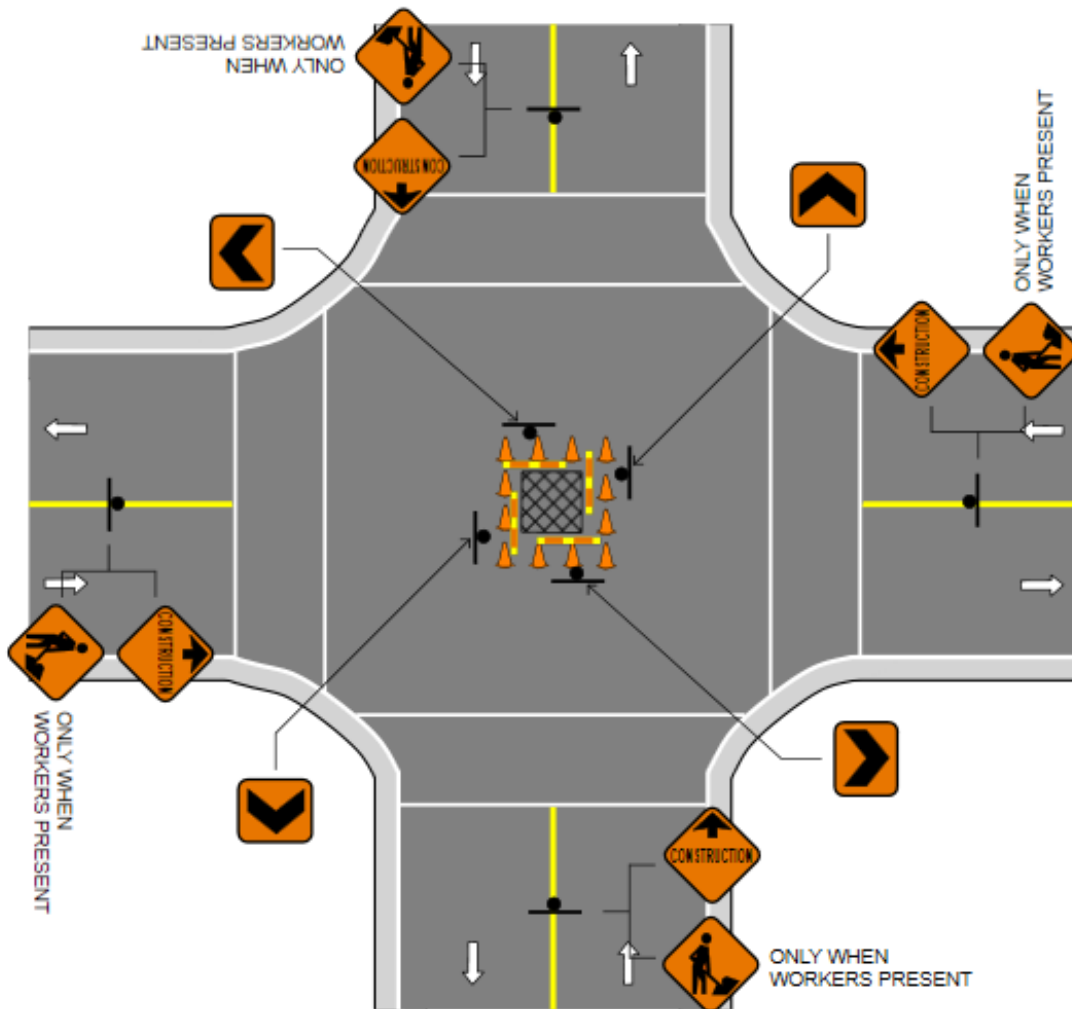

NOTE:
This drawing is a graphical representation of the detour setup. It is NOT drawn to scale.

GUIDELINE 1 FOR LANE CLOSURE TAPER 1 AND LONGITUDINAL BUFFER SPACE					
V(km/h)	A(m)	L(m)	B(m)	D(m)	
50	50	30	35	8	SHORT TERM
60	50	40	45	12	SHORT TERM
70	75	60	50	15	SHORT TERM
80	100	80	60	15	LONG TERM
90	100	105	65	18	LONG TERM
100	125	125	70	18	LONG TERM

Where:
V = Posted Speed Limit
A = Spacing between Signs
L = Length of Taper
B = Length of Longitudinal Buffer Space
D = Spacing between Delineation Devices

15. INTERSECTION WORK – EXAMPLE 1

16 – INTERSECTION WORK – EXAMPLE 2

1. EXAMPLE SHOWN

Four-legged intersection. Two approaching lanes in all directions.

2. CONDITIONS

Single lane closure in all directions.

3. OBSERVATIONS

Note lane closures completed before reaching intersection.

4. SET-UP PROCEDURE

Set-up advance warning signs and tapers in each direction. Start from edges of diagram, working towards worksite in order shown.

Post traffic control persons to protect workers.

Outline worksite with cones.

Commence work.

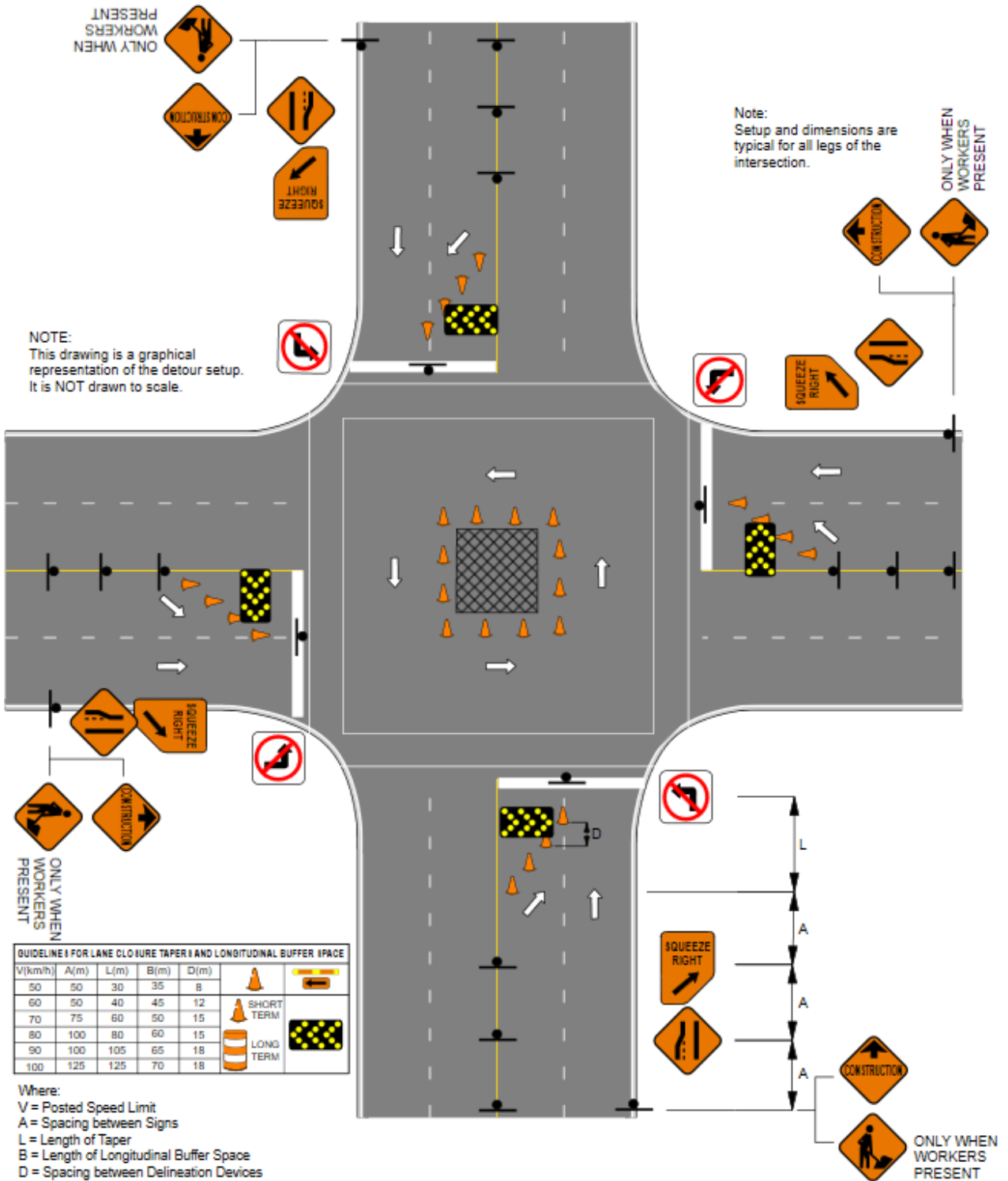

16. INTERSECTION WORK – EXAMPLE 2

17 – INTERSECTION WORK – EXAMPLE 3

1. EXAMPLE SHOWN

Four-legged intersection. Two approaching lanes in all directions.

2. CONDITIONS

Single lane closure.

Single mandatory right lane condition.

3. OBSERVATIONS

Protect workers during set-up with traffic control persons.

Mandatory right lane may require closure depending on traffic volume.

4. SET-UP PROCEDURE

Set-up advance warning signs in order from right side of diagram.

Set-up advance warning signs and taper in order shown from top of diagram.

Set-up Lane Closure Arrow sign.

Outline worksite with cones.

Commence work.

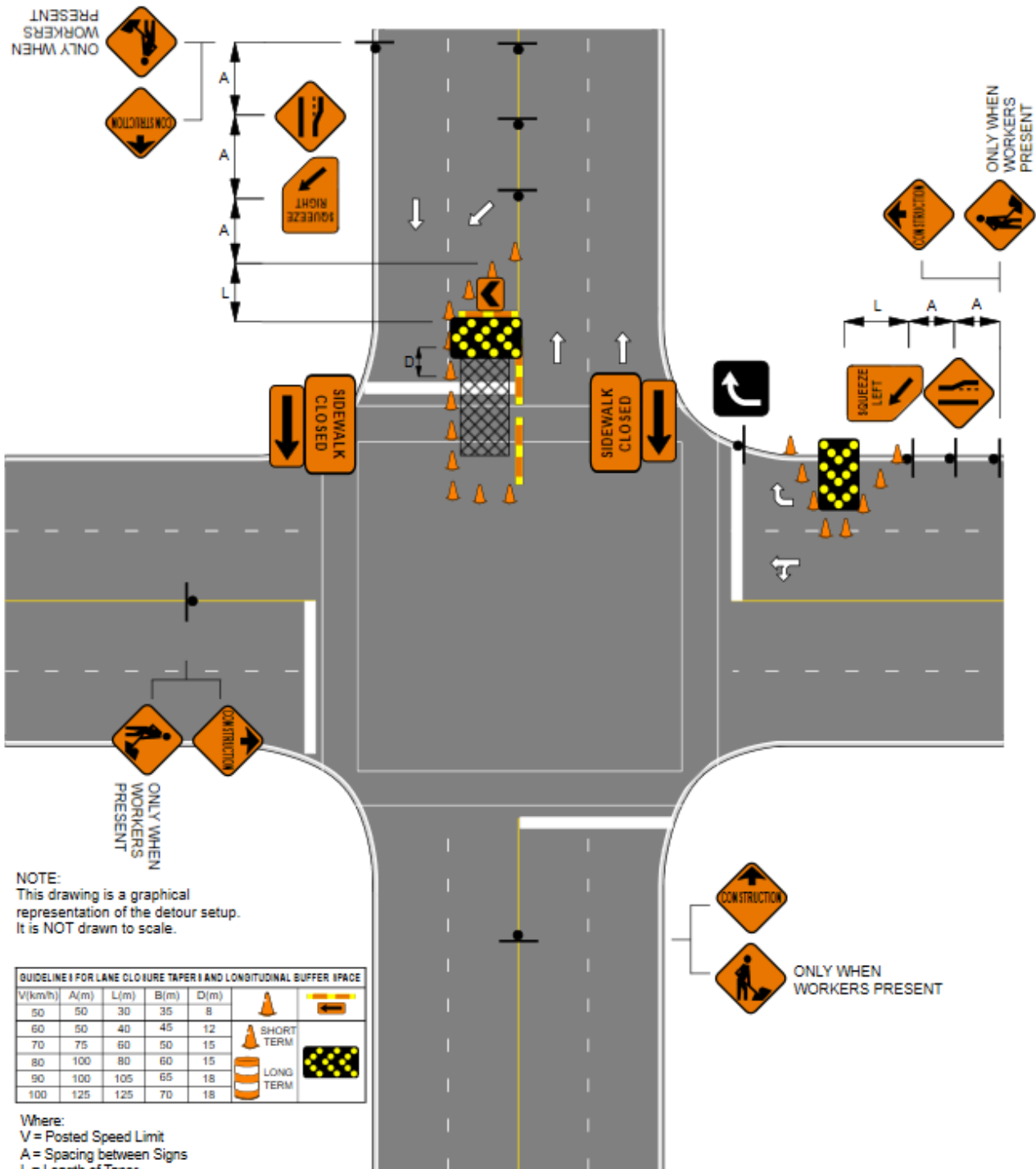

17. INTERSECTION WORK – EXAMPLE 3

18 – INTERSECTION WORK – EXAMPLE 4

1. EXAMPLE SHOWN

Four-legged intersection. Two approaching lanes in all directions.

2. CONDITIONS

Single mandatory right-lane condition.

Single mandatory left-lane condition.

3. OBSERVATIONS

Protect workers during set-up with traffic control persons.

Crosswalk closure.

4. SET-UP PROCEDURE

Set-up advance warning signs in order shown at top of diagram.

Set-up advance warning signs and taper in order shown from left side of diagram.

Post traffic control persons to protect workers.

Outline worksite with cones and barricades.

Commence work.

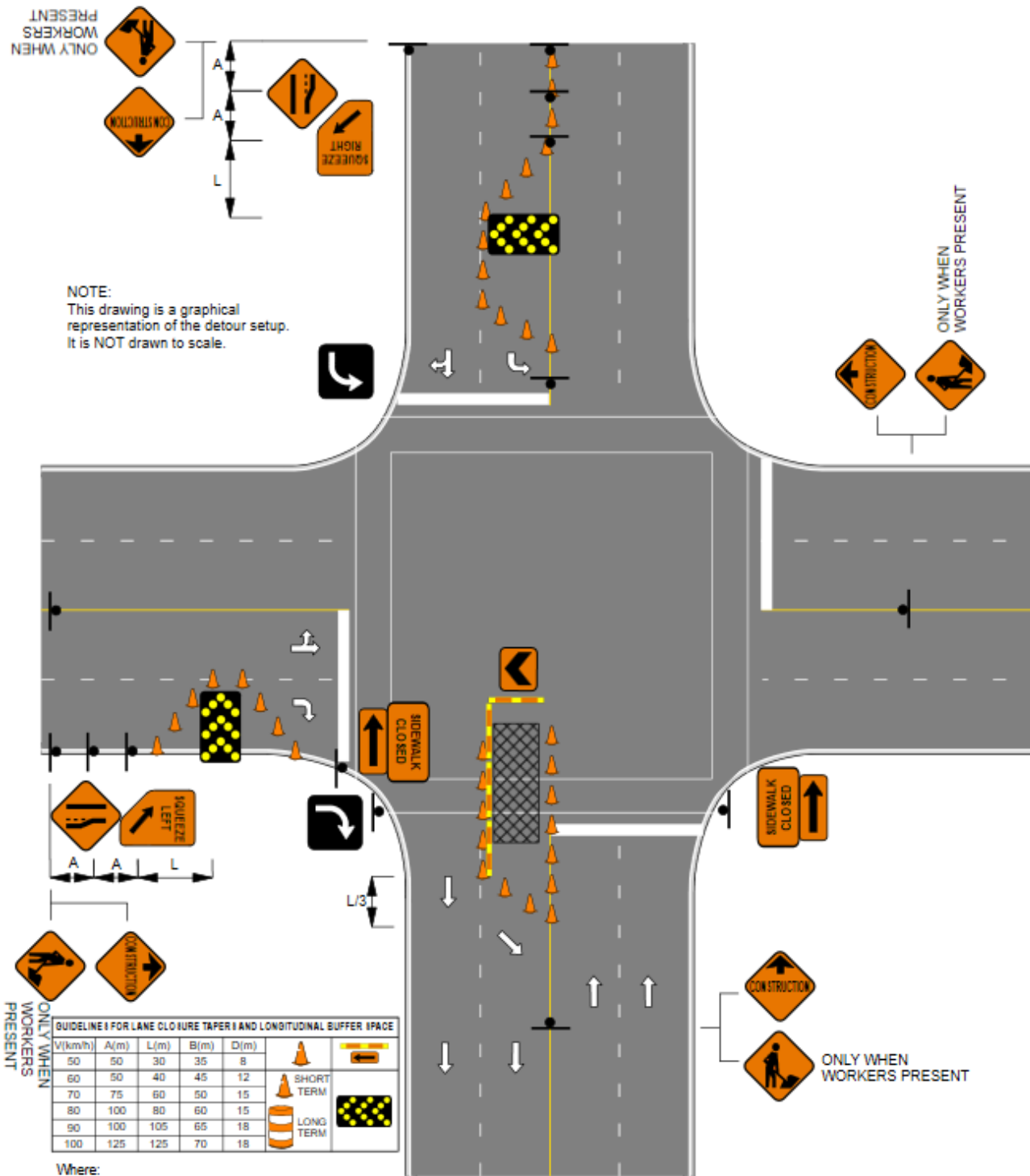

19 – INTERSECTION WORK – EXAMPLE 5

1. EXAMPLE SHOWN

Four-legged intersection. Two approaching lanes in all directions.

2. CONDITIONS

Two lanes closed in one direction.

Single lane closure in opposing direction.

3. OBSERVATIONS

Protect workers during set-up with traffic control persons.

Crosswalk closure.

4. SET-UP PROCEDURE

Start at bottom and the right side of the diagram. Set-up single-lane closure in order shown (except cones and signs in intersection). Set-up mandatory right-lane condition, Install Two-Way Traffic signs to top right of diagram.

Start at top of diagram. Set-up double-lane closure in order shown.

Post traffic control persons to protect workers.

Set-up cones and signs in intersection.

Commence work.

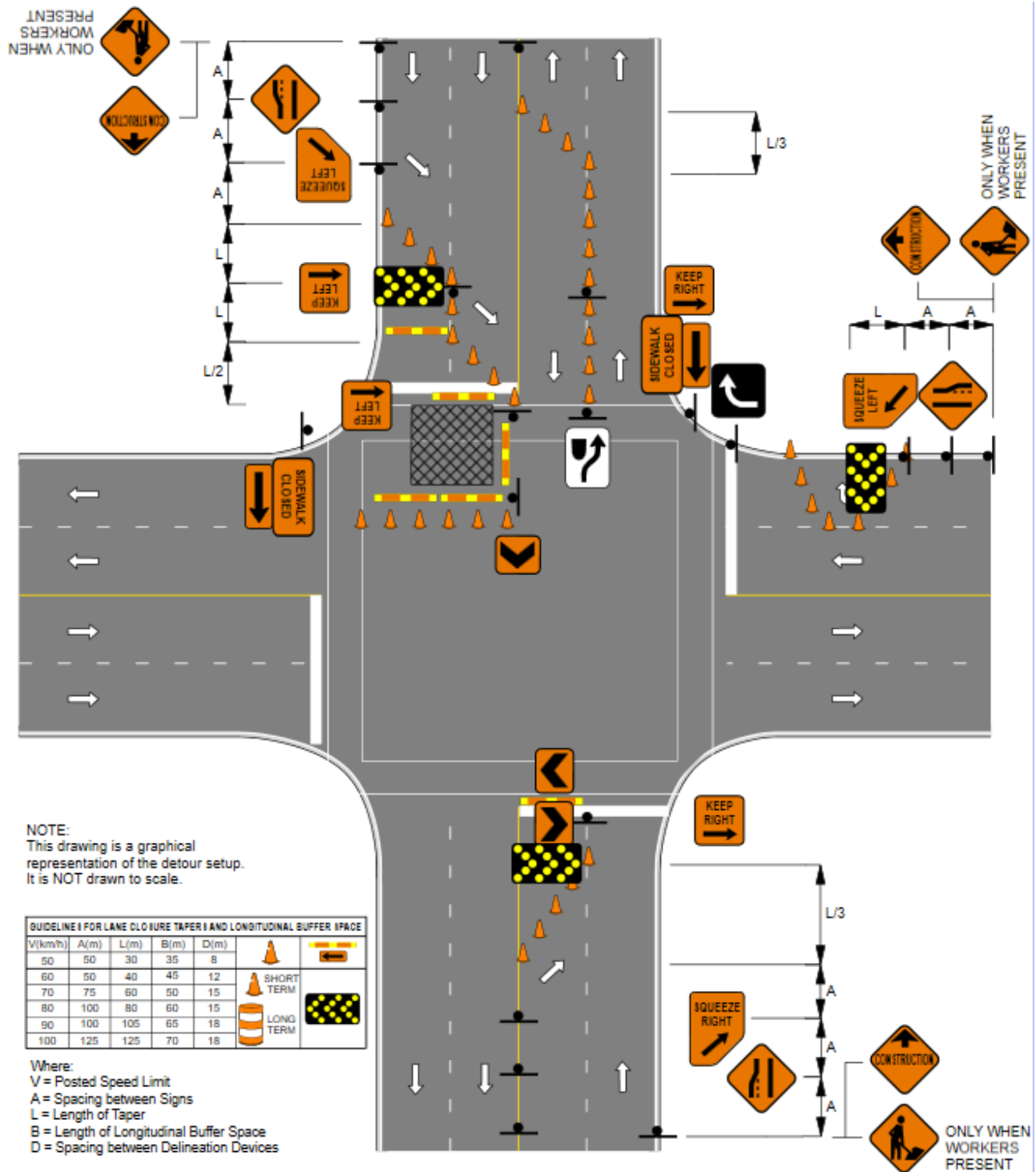

19. INTERSECTION WORK – EXAMPLE 5

20 – INTERSECTION WORK – EXAMPLE 6

1. EXAMPLE SHOWN

Four-legged intersection. Two approaching lanes in all directions.

2. CONDITIONS

Two lanes closed in one direction.

Single lane closure in one direction.

3. OBSERVATIONS

Protect workers during set-up with traffic control persons.

Crosswalk closure.

4. SET-UP PROCEDURE

Start at top left of diagram. Set-up advance warning signs in order shown.

Start at the bottom and the left side of the diagram. Set-up single-lane closures in order shown (except for cones and signs in the intersection).

Post traffic control persons to protect workers.

Set-up signs in intersection.

Outline work area with cones.

Commence work.

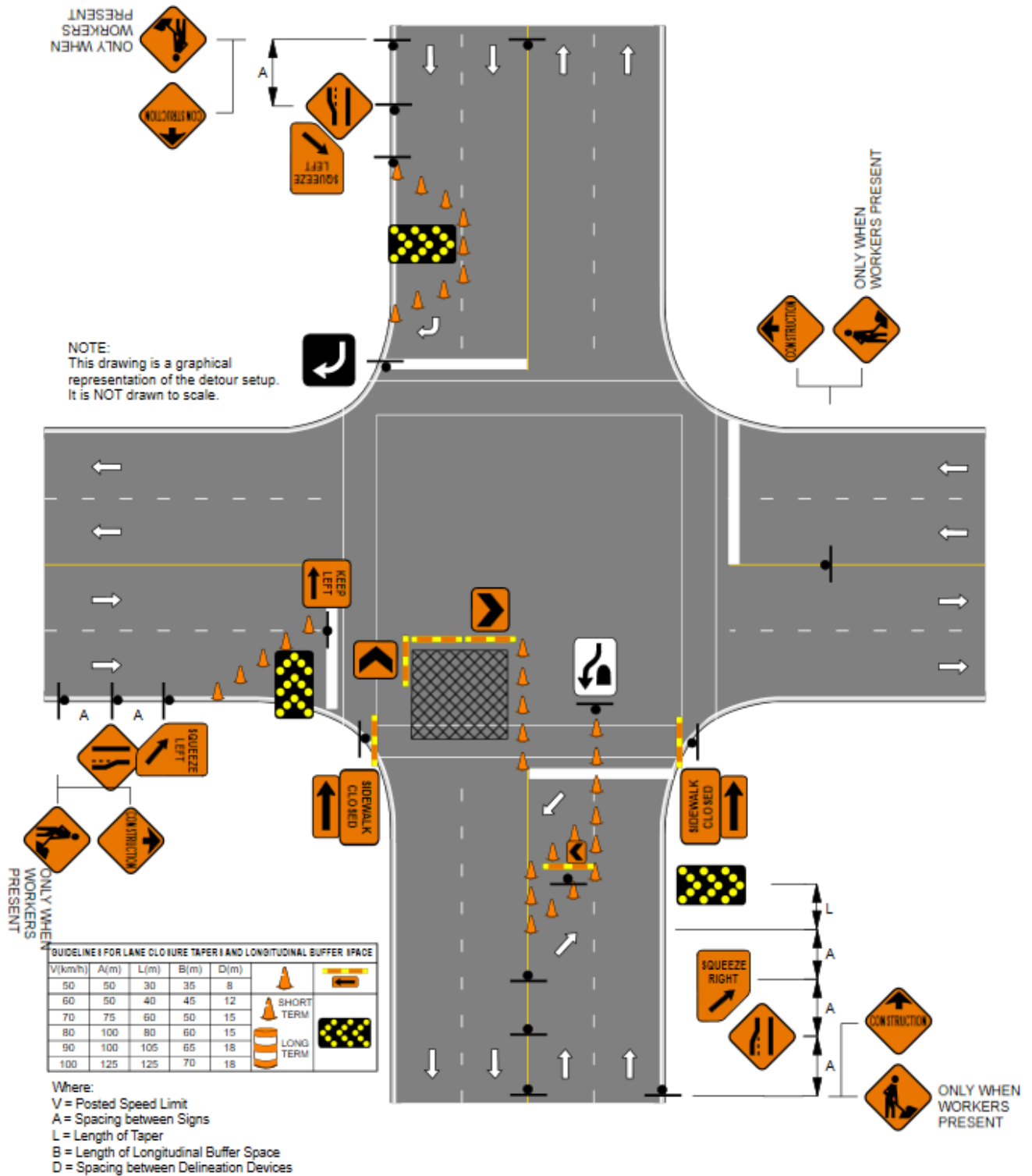

20. INTERSECTION WORK – EXAMPLE 6

21 – BACK LANE CLOSURES

1. EXAMPLE SHOWN

Residential back lane.

2. CONDITIONS

One complete closure.

Partially closed alley.

3. OBSERVATIONS

Construction markers and flashers to be used at night and during periods of inactivity.

4. SET-UP PROCEDURE

As shown.

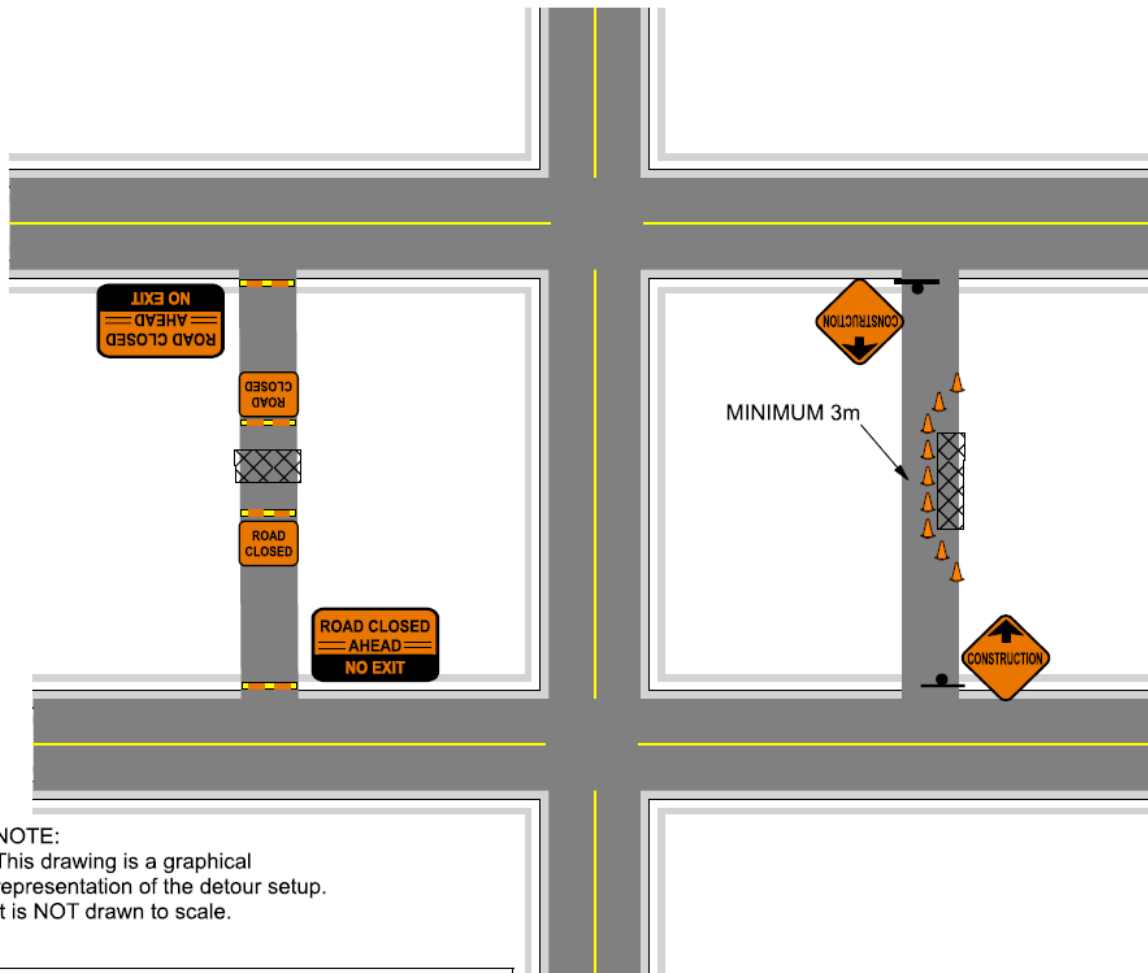

NOTE:
This drawing is a graphical representation of the detour setup. It is NOT drawn to scale.

GUIDELINES FOR LANE CLOSURE TAPERS AND LONGITUDINAL BUFFER SPACE						
V(km/h)	A(m)	L(m)	B(m)	D(m)		
50	50	30	35	8		
60	50	40	45	12		SHORT TERM
70	75	60	50	15		
80	100	80	60	15		LONG TERM
90	100	105	65	18		
100	125	125	70	18		

Where:
 V = Posted Speed Limit
 A = Spacing between Signs
 L = Length of Taper
 B = Length of Longitudinal Buffer Space
 D = Spacing between Delineation Devices

22 – ROAD CLOSURE

1. EXAMPLE SHOWN

Two-lane – two-way street.

2. CONDITIONS

Complete road closure.

Detour to adjacent streets.

3. OBSERVATIONS

Note detour signs show direction throughout traffic control zone.

Note closure of adjacent streets.

4. SET-UP PROCEDURE

Set-up all detour signs.

Set-up all other signs. Close side streets.

Secure work area.

Commence work.

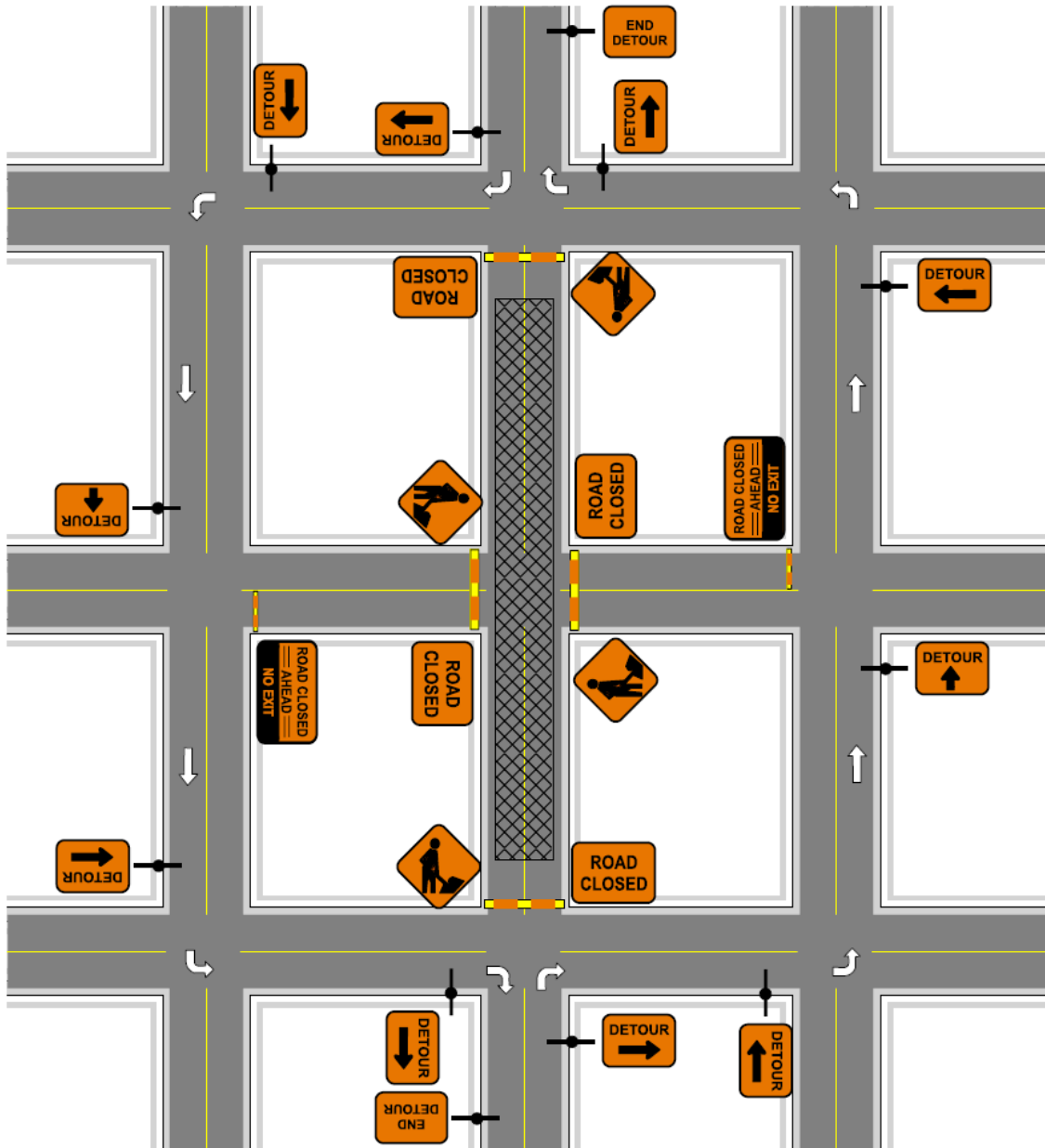

GUIDELINES FOR LANE CLOSURE TAPERS AND LONGITUDINAL BUFFER SPACE

V(km/h)	A(m)	L(m)	B(m)	D(m)	Signage
50	50	30	35	8	SHORT TERM
60	50	40	45	12	
70	75	60	50	15	LONG TERM
80	100	80	60	15	
90	100	105	65	18	
100	125	125	70	18	

NOTE:
This drawing is a graphical representation of the detour setup. It is NOT drawn to scale.

Where:
 V = Posted Speed Limit
 A = Spacing between Signs
 L = Length of Taper
 B = Length of Longitudinal Buffer Space
 D = Spacing between Delineation Devices

23 – LOCAL ROAD ONE-WAY CLOSURE

1. EXAMPLE SHOWN

Two-Way Local Residential Street.

2. CONDITIONS

SB lane closure.

One-directional road closure

3. OBSERVATIONS

Must have Road Closed and Do Not Enter signs

Additional No Turn signs and One-Way signs can be added if required

4. SET-UP PROCEDURE

Set-up Road Closed and Do Not Enter signs.

Set-up additional signs if required

Set-up cones along the center of the road.

Commence work.

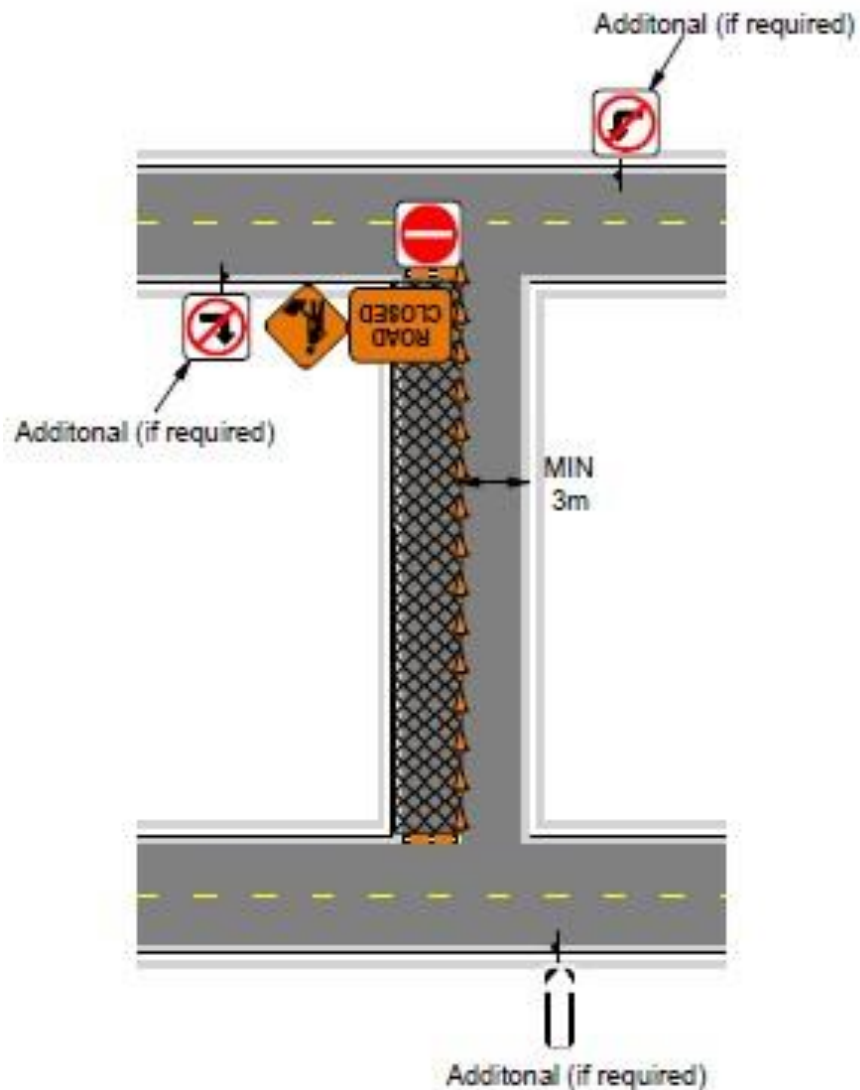

NOTE:
This drawing is a graphical representation of the detour setup. It is NOT drawn to scale.

GUIDELINES FOR LANE CLOSURE TAPERS AND LONGITUDINAL BUFFER SPACE						
V(km/h)	A(m)	L(m)	B(m)	D(m)		
50	50	30	35	8		
60	50	40	45	12	SHORT TERM	
70	75	60	50	15		
80	100	80	60	15	LONG TERM	
90	100	105	65	18		
100	125	125	70	18		

Where:
V = Posted Speed Limit
A = Spacing between Signs
L = Length of Taper
B = Length of Longitudinal Buffer Space
D = Spacing between Delineation Devices

24 – LOCAL ROAD SPEED REDUCTION (MAX 30KM/H)

1. EXAMPLE SHOWN

Two-lane – two-way street.

2. CONDITIONS

Curb lane closure.

Partial road closure

3. OBSERVATIONS

***MAX 30KM/H SIGNS CAN ONLY BE USED ON LOCAL ROADS*.**

Max 30km/h signs must be removed during periods of inactivity

4. SET-UP PROCEDURE

Set-up first Max 30km/h sign on the side of the road that the work is taking place as per diagram.

Set-up cones around work zone.

Set-up second Max 30km/h sign at the end of the work-zone as shown in the diagram.

Commence work.

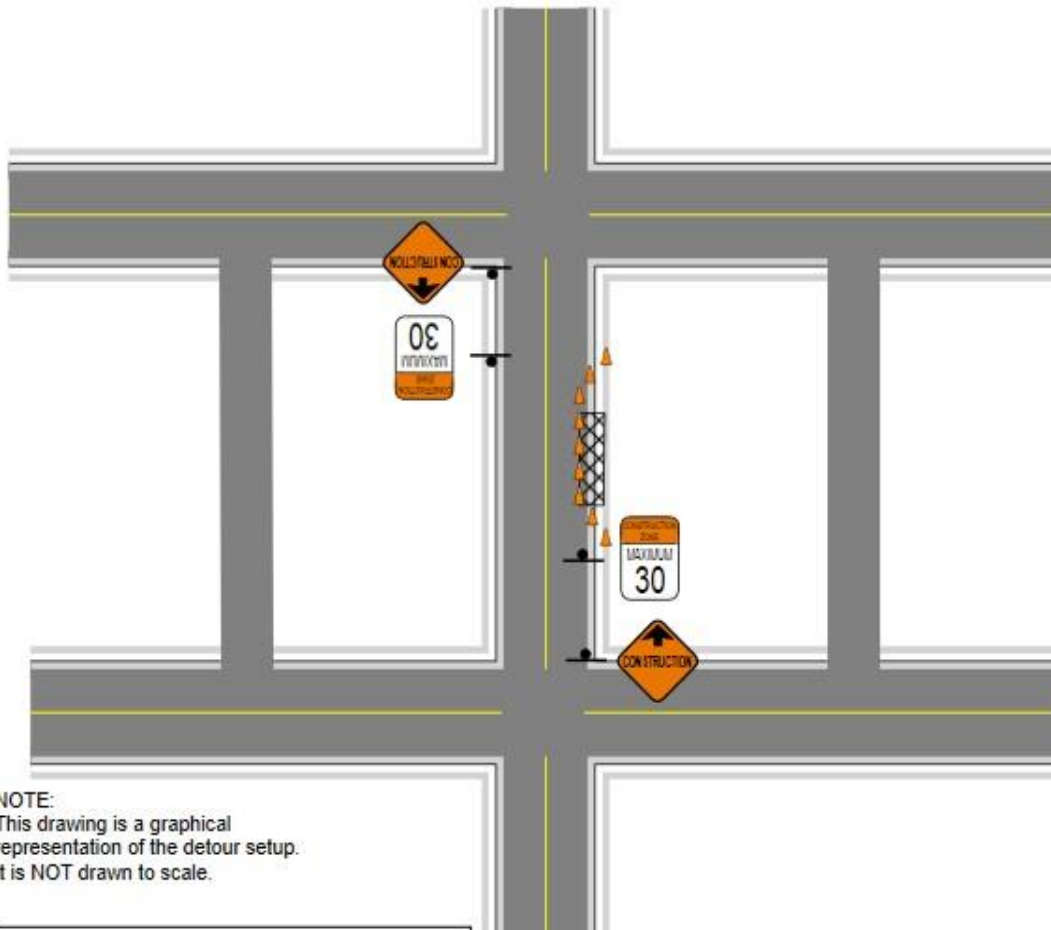

NOTE:
This drawing is a graphical
representation of the detour setup.
It is NOT drawn to scale.

GUIDELINES FOR LANE CLOSURE TAPERS AND LONGITUDINAL BUFFER SPACE					
V(km/h)	A(m)	L(m)	B(m)	D(m)	
50	50	30	35	8	
60	50	40	45	12	
70	75	60	50	15	
80	100	80	60	15	
90	100	105	65	18	
100	125	125	70	18	

Where:
V = Posted Speed Limit
A = Spacing between Signs
L = Length of Taper
B = Length of Longitudinal Buffer Space
D = Spacing between Delineation Devices

25 – ROAD DIVERSION TWO DIRECTIONS

1. EXAMPLE SHOWN

Two-lane – two-way street.

2. CONDITIONS

Complete requires diversion.

3. OBSERVATIONS

May require speed reduction.

Note use of delineators around diversion. Construction markers and flashers to be used at night and during periods of inactivity.

Use traffic control persons to protect workers during set-up.

Use of chevrons to be considered depending on horizontal alignment.

4. SET-UP PROCEDURE

Build diversion route where necessary to accepted standards

Set-up delineators, barricades and signs on both sides of diversion.

Commence work.

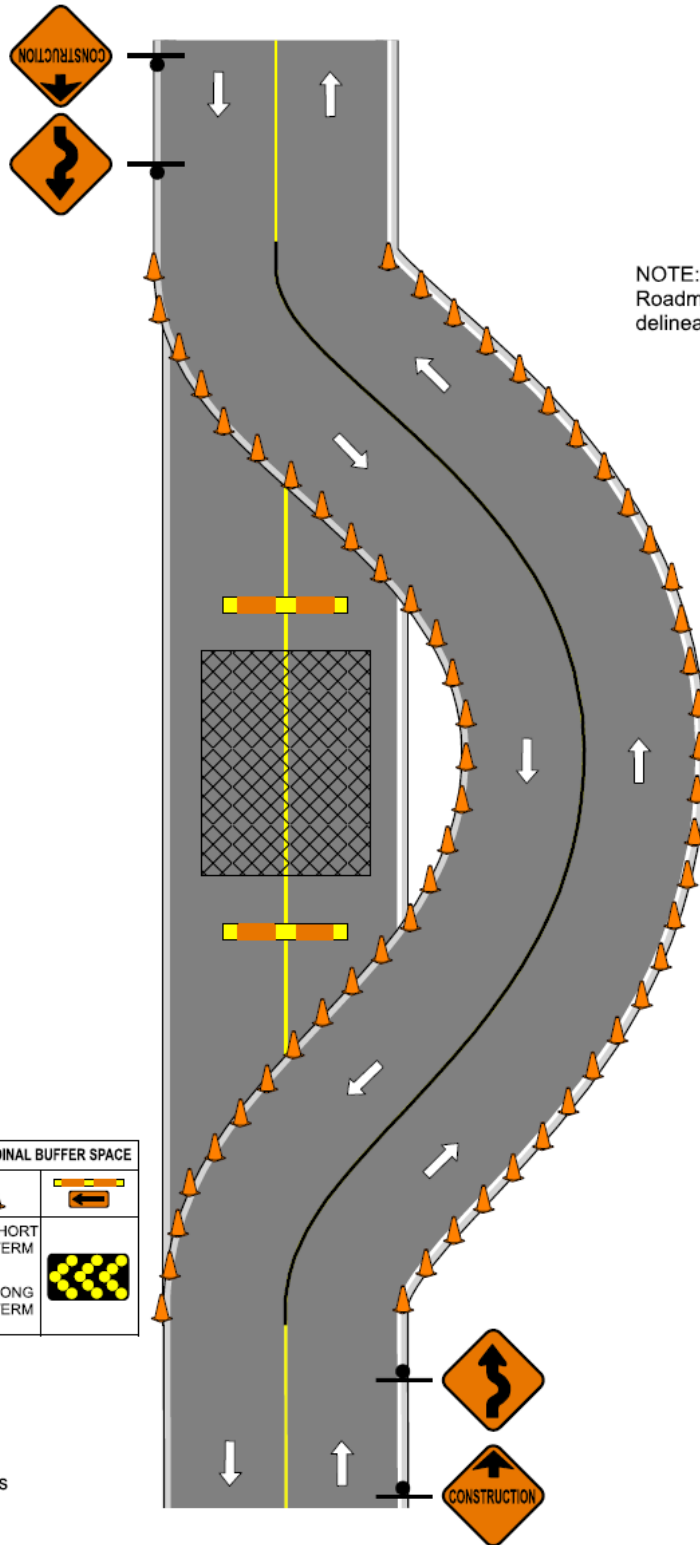

NOTE:
Roadmarking or centreline delineation may be required.

NOTE:
This drawing is a graphical representation of the detour setup. It is NOT drawn to scale.

GUIDELINES FOR LANE CLOSURE TAPERS AND LONGITUDINAL BUFFER SPACE					
V(km/h)	A(m)	L(m)	B(m)	D(m)	
50	50	30	35	8	SHORT TERM
60	50	40	45	12	
70	75	60	50	15	
80	100	80	60	15	LONG TERM
90	100	105	65	18	
100	125	125	70	18	

Where:
 V = Posted Speed Limit
 A = Spacing between Signs
 L = Length of Taper
 B = Length of Longitudinal Buffer Space
 D = Spacing between Delineation Devices

25. ROAD DIVERSION TWO DIRECTIONS

26 – SHOULDER DETOUR

1. EXAMPLE SHOWN

Four-lane – two-way street with shoulder.

2. CONDITIONS

Two-lane closure requires shoulder detour.

3. OBSERVATIONS

May require speed reduction.

Use traffic control persons to protect workers during set-up.

Shoulder must be able to withhold traffic load. Median crossover may be alternative option.

4. SET-UP PROCEDURE

Set-up delineators and barricades along shoulder to mark detour.

Post traffic control persons.

Start at bottom of diagram. Set-up double-lane closure in order shown.

Commence work.

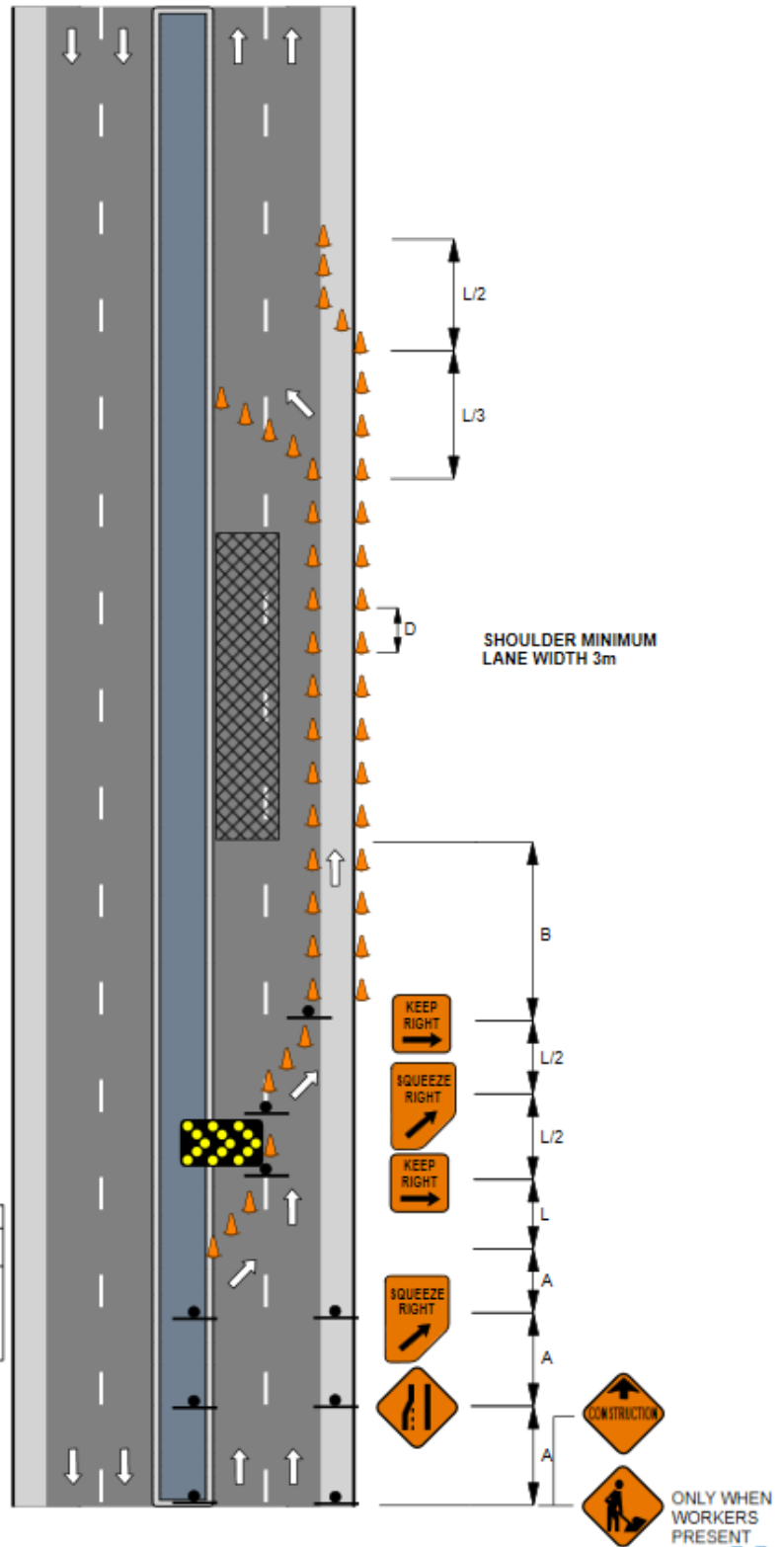

NOTE:
This drawing is a graphical representation of the detour setup. It is NOT drawn to scale.

GUIDELINES FOR LANE CLOSURE TAPER AND LONGITUDINAL BUFFER SPACE					
V(km/h)	A(m)	L(m)	B(m)	D(m)	
50	50	30	35	8	SHORT TERM
60	50	40	45	12	
70	75	60	50	15	LONG TERM
80	100	80	60	15	
90	100	105	65	18	
100	125	125	70	18	

Where:
 V = Posted Speed Limit
 A = Spacing between Signs
 L = Length of Taper
 B = Length of Longitudinal Buffer Space
 D = Spacing between Delineation Devices

26. SHOULDER DETOUR

27(a) – PARTIAL SIDEWALK CLOSURE

1. EXAMPLE SHOWN

Pedestrian detour.

2. CONDITIONS

Pedestrians must be notified in advance at first available crossing/crosswalk.

3. OBSERVATIONS

Note barricades with continuous detectable edging at ground level to physically separate pedestrians from worksite. The barricades must be continuous, stable and non-flexible (rigid).

4. SET-UP PROCEDURE

Co-ordinate with other work in the area to ensure that the sidewalk on the opposite side of the road will be available for pedestrian use for the duration of the proposed sidewalk closure.

Set-up signs directing pedestrians and barricade worksite.

Commence work.

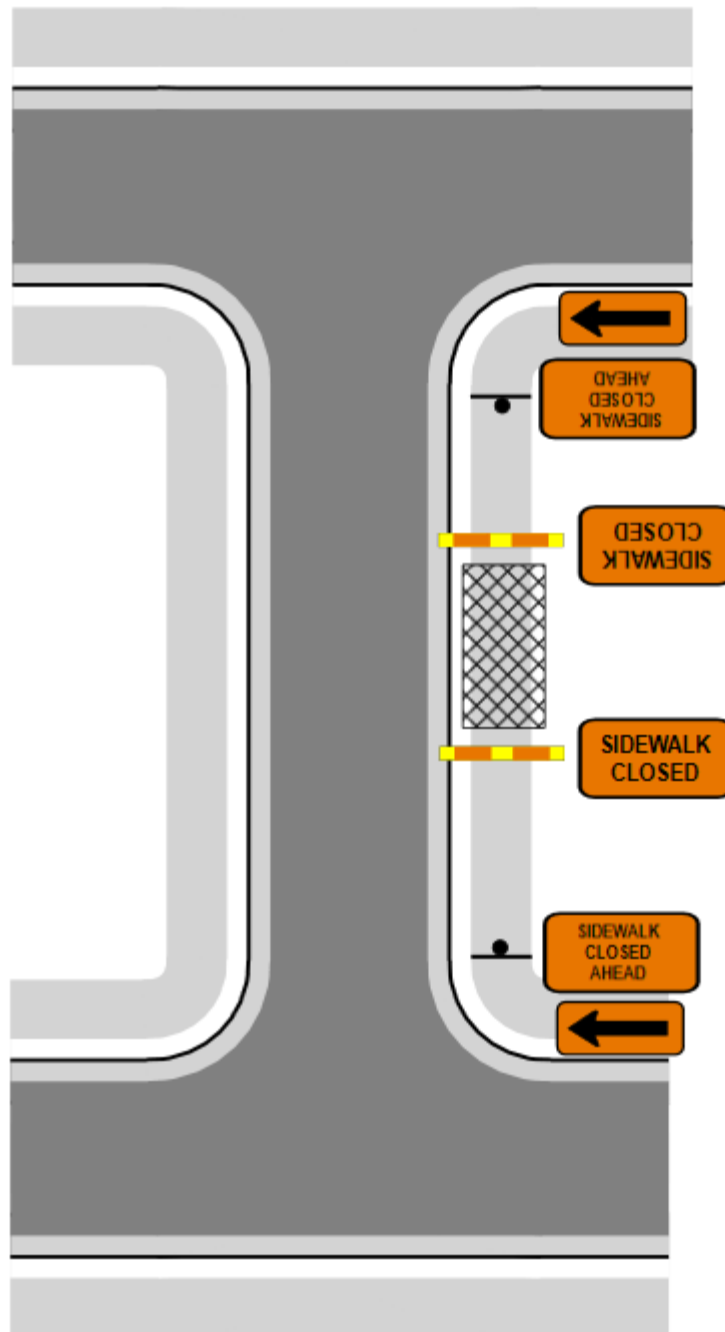

NOTE:
This drawing is a graphical
representation of the detour setup.
It is NOT drawn to scale.

27(a). PARTIAL SIDEWALK CLOSURE

27(b) – FULL SIDEWALK CLOSURE

1. EXAMPLE SHOWN

Pedestrian detour.

2. CONDITIONS

Pedestrians must be physically separated from vehicular traffic and the worksite.

3. OBSERVATIONS

Note barricades with continuous detectable edging at ground level to physically separate pedestrians from worksite. The barricades must be continuous, stable and non-flexible (rigid).

Sidewalk Closed signs direct pedestrians to alternative sidewalk.

4. SET-UP PROCEDURE

Co-ordinate with other work in the area to ensure that the sidewalk on the opposite side of the road will be available for pedestrian use for the duration of the proposed sidewalk closure.

Set-up Sidewalk Closed signs and barricade worksite.

Commence work.

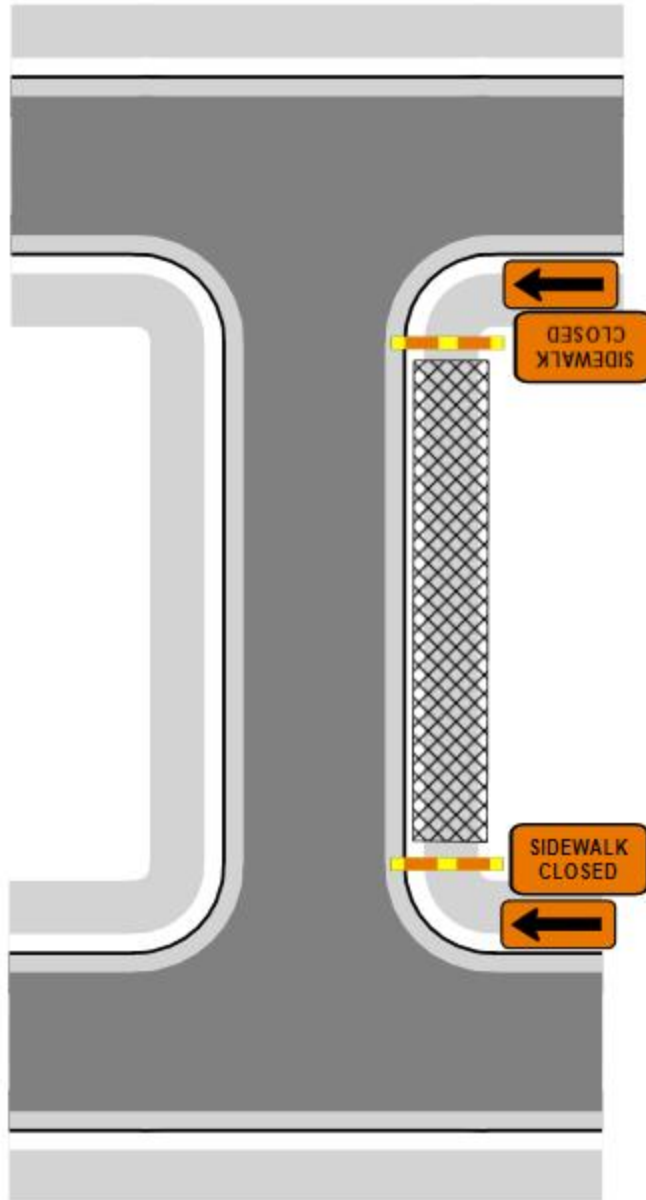

NOTE:
This drawing is a graphical
representation of the detour setup.
It is NOT drawn to scale.

27(b). FULL SIDEWALK CLOSURE

27(c) – PARTIAL SIDEWALK CLOSURE WITH PARKING LANE

1. EXAMPLE SHOWN

Pedestrian detour.

2. CONDITIONS

Pedestrians must be notified in advance at first available crossing/crosswalk.

3. OBSERVATIONS

Note barricades with continuous detectable edging at ground level to physically separate pedestrians from worksite. The barricades must be continuous, stable and non-flexible (rigid).

Sidewalk Closed signs direct pedestrians to alternative sidewalk.

4. SET-UP PROCEDURE

Co-ordinate with other work in the area to ensure that the sidewalk on the opposite side of the road will be available for pedestrian use for the duration of the proposed sidewalk closure.

Set-up signs directing pedestrians and barricade worksite.

Commence work.

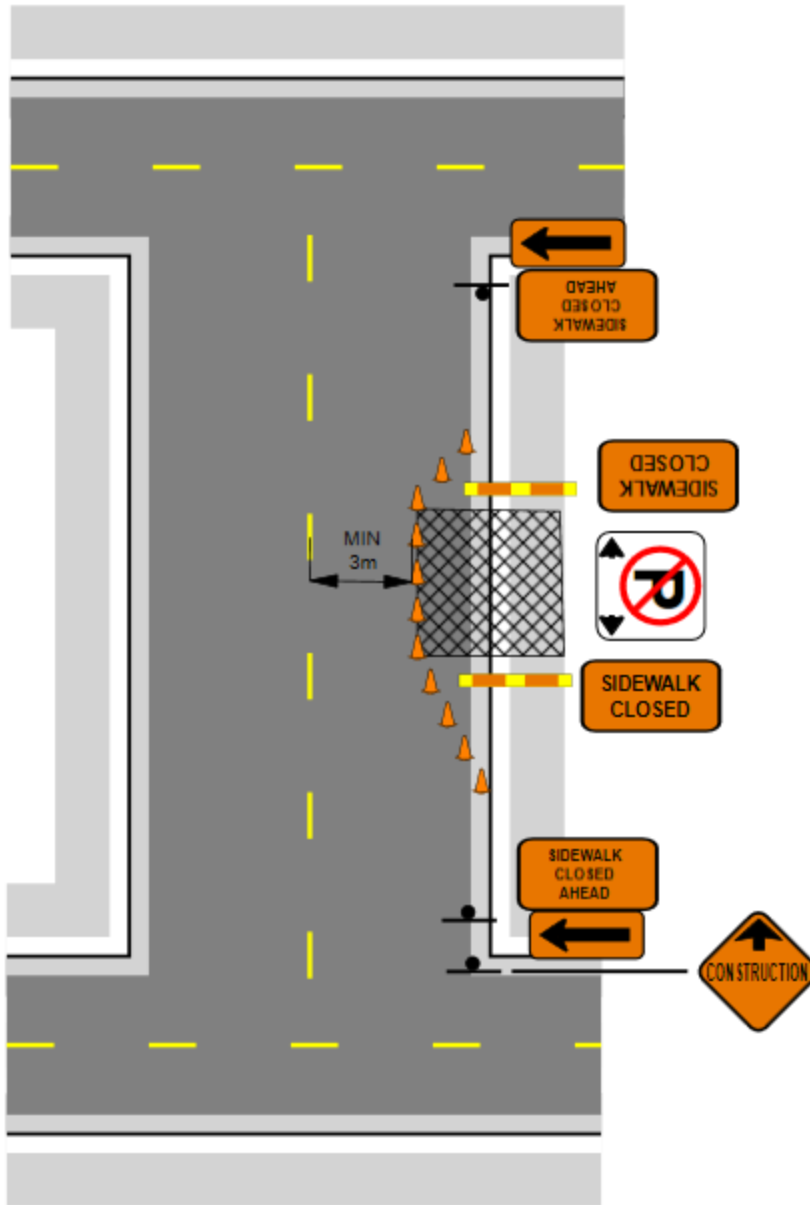

NOTE:
This drawing is a graphical
representation of the detour setup.
It is NOT drawn to scale.

27(c). PARTIAL SIDEWALK CLOSURE WITH PARKING LANE

27(d) – FULL SIDEWALK CLOSURE WITH PARKING LANE

1. EXAMPLE SHOWN

Pedestrian detour.

2. CONDITIONS

Pedestrians must be physically separated from vehicular traffic and the worksite.

3. OBSERVATIONS

Note barricades with continuous detectable edging at ground level to physically separate pedestrians from worksite. The barricades must be continuous, stable and non-flexible (rigid).

Sidewalk Closed signs direct pedestrians to alternative sidewalk.

4. SET-UP PROCEDURE

Co-ordinate with other work in the area to ensure that the sidewalk on the opposite side of the road will be available for pedestrian use for the duration of the proposed sidewalk closure.

Set-up Sidewalk Closed signs and barricade worksite.

Commence work.

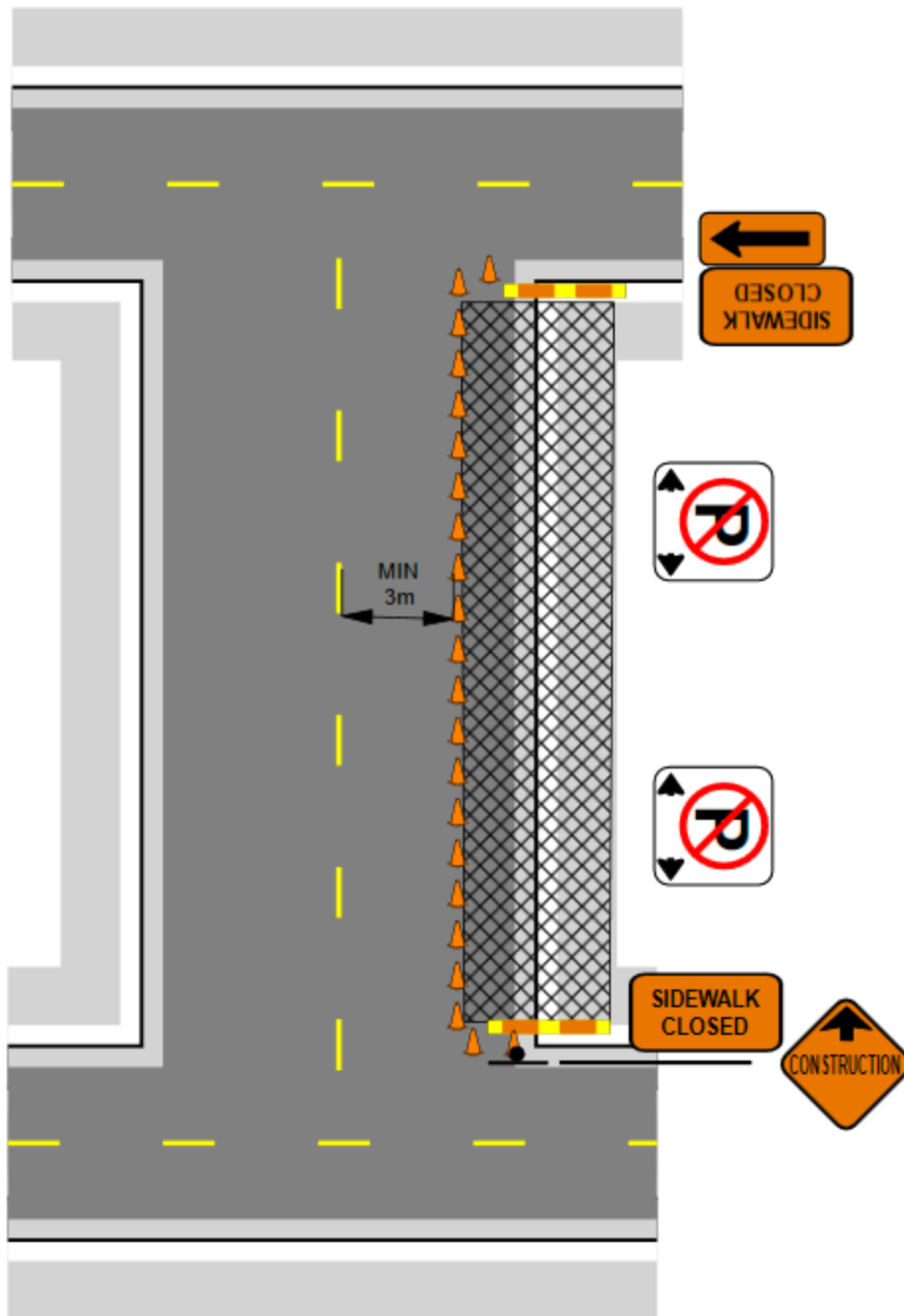

NOTE:
This drawing is a graphical
representation of the detour setup.
It is NOT drawn to scale.

27(d). FULL SIDEWALK CLOSURE WITH PARKING LANE

27(e) – PARTIAL SIDEWALK CLOSURE MID-BLOCK, WITH PEDESTRIAN ACCOMODATIONS

1. EXAMPLE SHOWN

Pedestrian detour / lane closure.

2. CONDITIONS

Pedestrians must be physically separated from vehicular traffic and the worksite.

3. OBSERVATIONS

Note barricades with continuous detectable edging at ground level to physically separate pedestrians from worksite. The barricades must be continuous, stable and non-flexible (rigid). Portable ramps must be used for transition from sidewalk to roadway.

4. SET-UP PROCEDURE

Set-up signs directing pedestrians and barricade worksite.
Commence work.

NOTE:
This drawing is a graphical
representation of the detour setup.
It is NOT drawn to scale.

GUIDELINES FOR LANE CLOSURE TAPER AND LONGITUDINAL BUFFER SPACE					
V(kmh)	A(m)	L(m)	B(m)	D(m)	
50	50	30	35	8	SHORT TERM
60	50	40	45	12	SHORT TERM
70	75	60	50	15	SHORT TERM
80	100	80	60	15	LONG TERM
90	100	105	65	18	LONG TERM
100	125	125	70	18	LONG TERM

Where:
V = Posted Speed Limit
A = Spacing between Signs
L = Length of Taper
B = Length of Longitudinal Buffer Space
D = Spacing between Delineation Devices

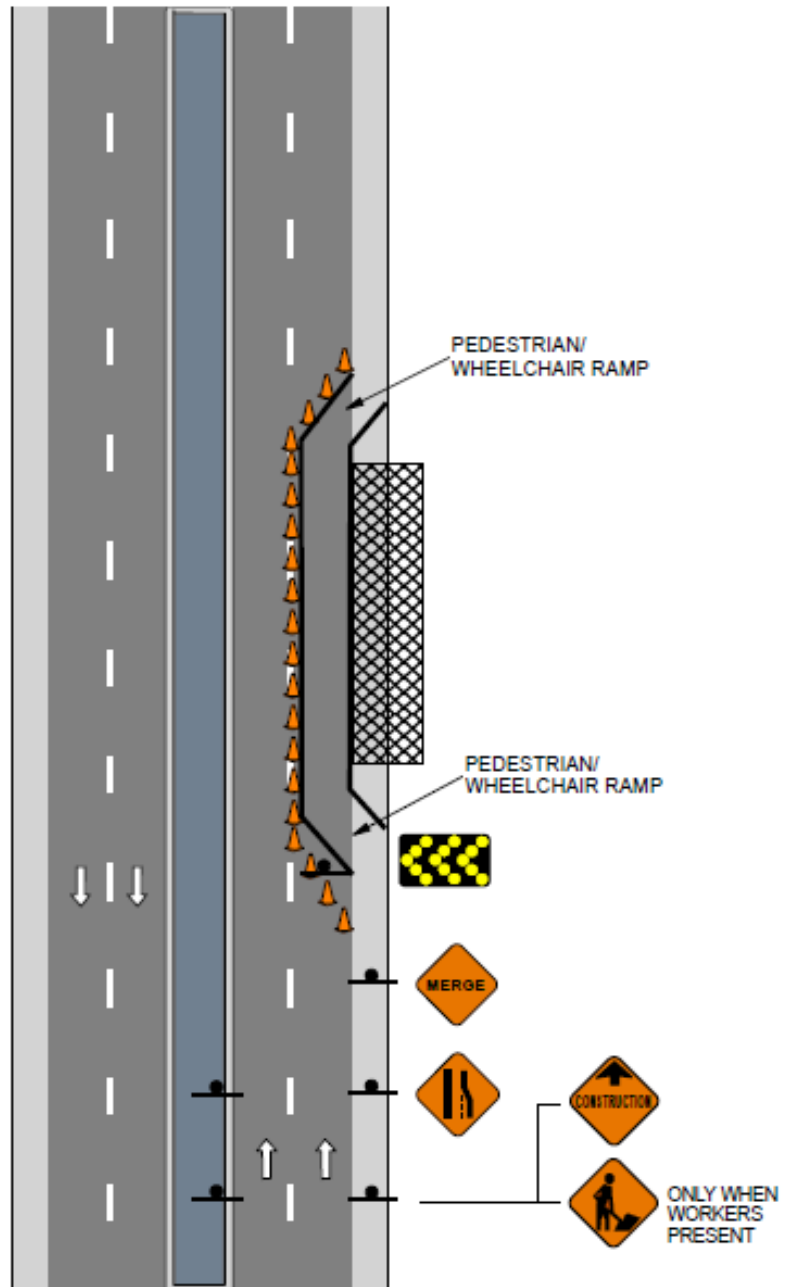

27(e). PARTIAL SIDEWALK CLOSURE MID-BLOCK, WITH PEDESTRIAN ACCOMODATIONS

27(f) – PARTIAL SIDEWALK CLOSURE AT INTERSECTION WITH PEDESTRIAN ACCOMODATIONS

1. EXAMPLE SHOWN

Pedestrian detour / lane closure.

2. CONDITIONS

Pedestrians must be physically separated from vehicular traffic and the worksite.

3. OBSERVATIONS

Note barricades with continuous detectable edging at ground level to physically separate pedestrians from worksite. The barricades must be continuous, stable and non-flexible (rigid). Portable ramps must be used for transition from sidewalk to roadway.

4. SET-UP PROCEDURE

Set-up signs directing pedestrians and barricade worksite.
Commence work.

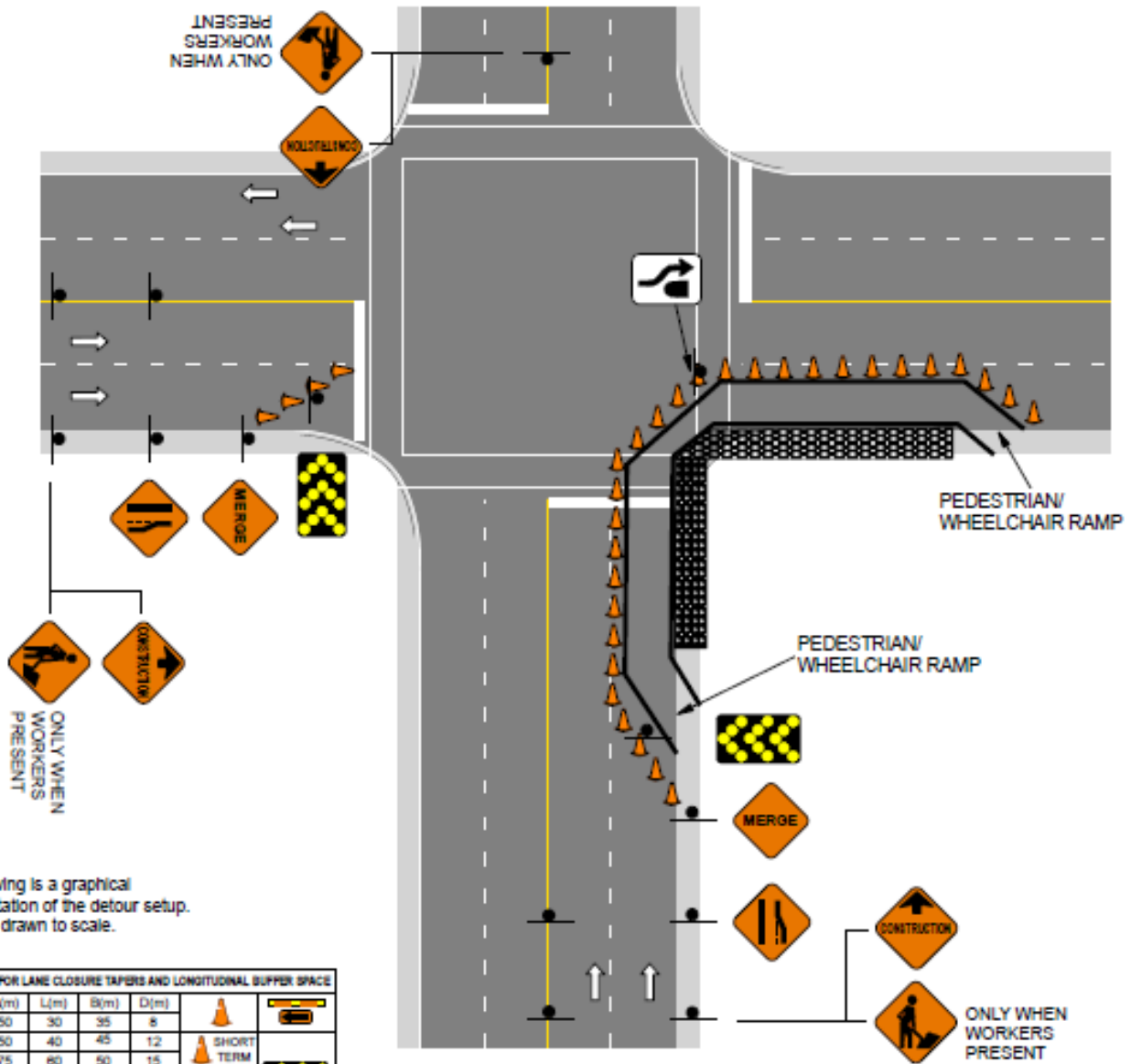

NOTE:
This drawing is a graphical representation of the detour setup. It is NOT drawn to scale.

GUIDELINES FOR LANE CLOSURE TAPERS AND LONGITUDINAL BUFFER SPACE					SHORT TERM	LONG TERM
V(km/h)	A(m)	L(m)	B(m)	D(m)		
50	50	30	35	8	SHORT TERM	LONG TERM
60	50	40	45	12		
70	75	60	50	15	LONG TERM	LONG TERM
80	100	80	60	15		
90	100	105	65	18	LONG TERM	LONG TERM
100	125	125	70	18		

Where:
V = Posted Speed Limit
A = Spacing between Signs
L = Length of Taper
B = Length of Longitudinal Buffer Space
D = Spacing between Delineation Devices

27(f). PARTIAL SIDEWALK CLOSURE AT INTERSECTION, WITH PEDESTRIAN ACCOMODATIONS

28 – MOBILE – SHOULDER WORK

1. EXAMPLE SHOWN

Two-lane – one-way street.

2. CONDITIONS

Mobile/moving jobs are those that are typically done on the move at low speed and may require periodic stopping for only a few minutes duration.

3. OBSERVATIONS

Delineation devices are not required if the operation does not involve stopping

4. SET-UP PROCEDURE



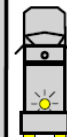
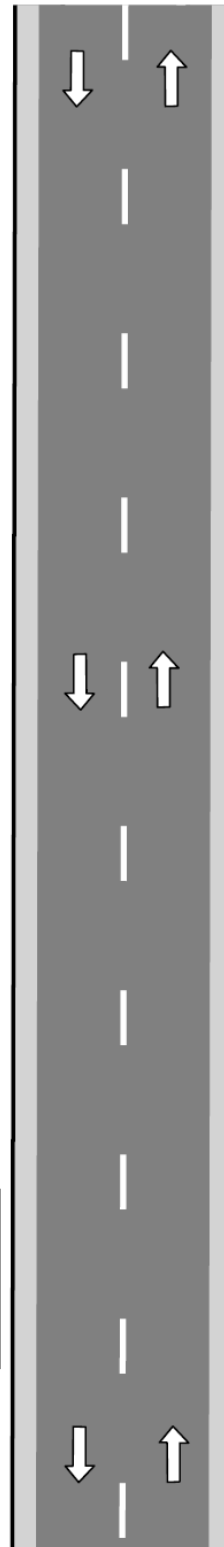

Set-up signage and devices as required.

Commence work.



360° BEACON AND 4-WAY FLASHERS

NOTE:
This drawing is a graphical representation of the detour setup. It is NOT drawn to scale.

GUIDELINES FOR LANE CLOSURE TAPERS AND LONGITUDINAL BUFFER SPACE						
V(km/h)	A(m)	L(m)	B(m)	D(m)		
50	50	30	35	8	 SHORT TERM	
60	50	40	45	12		
70	75	60	50	15	 LONG TERM	
80	100	80	60	15		
90	100	105	65	18		
100	125	125	70	18		

Where:
 V = Posted Speed Limit
 A = Spacing between Signs
 L = Length of Taper
 B = Length of Longitudinal Buffer Space
 D = Spacing between Delineation Devices

29 – MOBILE – ENCROACHMENT IN LANE

1. EXAMPLE SHOWN

Two-lane – one-way street.

2. CONDITIONS

Mobile/moving jobs are those that are typically done on the move at low speed and may require periodic stopping for only a few minutes duration.

3. OBSERVATIONS

Delineation devices are not required if the operation does not involve stopping

4. SET-UP PROCEDURE

Set-up signage and devices as required.

Commence work.

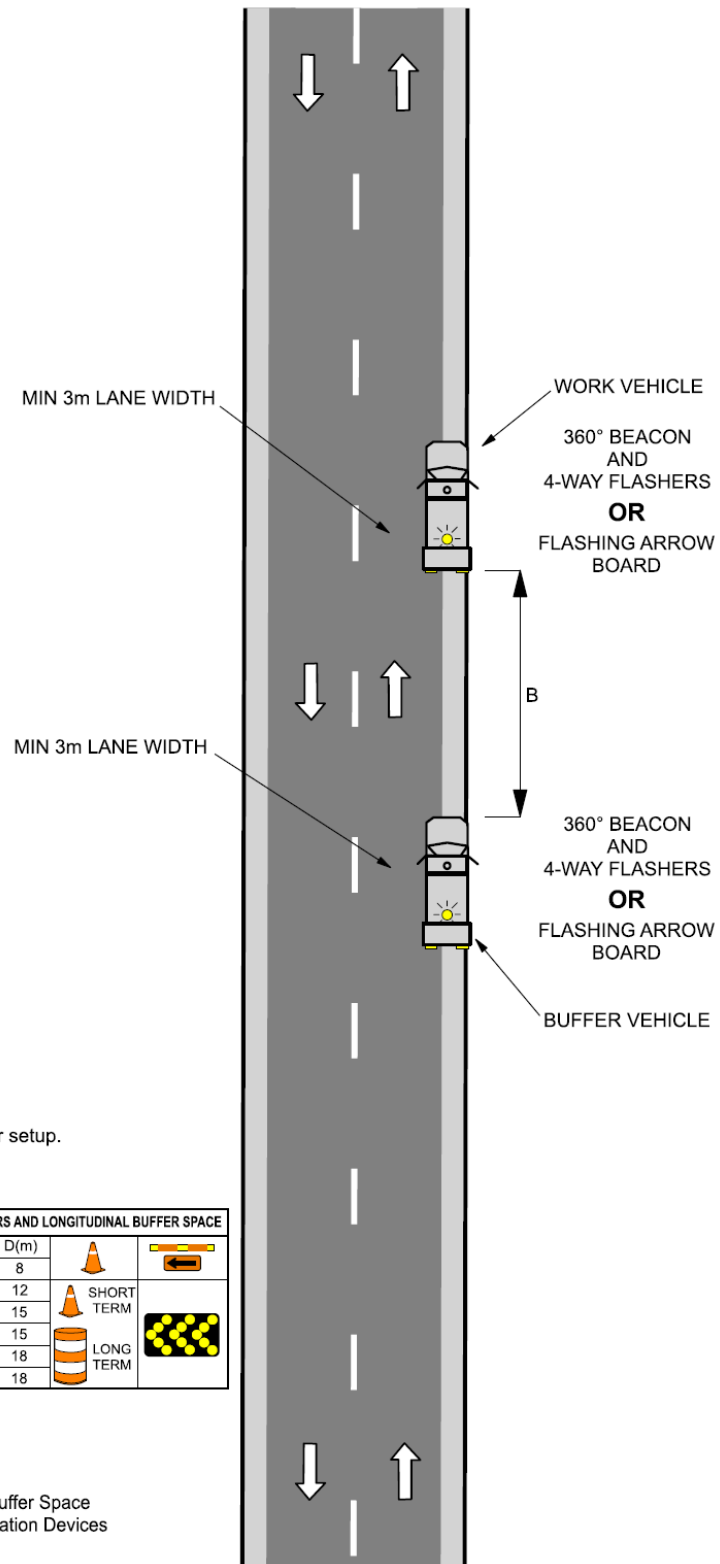

NOTE:
This drawing is a graphical representation of the detour setup. It is NOT drawn to scale.

GUIDELINES FOR LANE CLOSURE TAPERS AND LONGITUDINAL BUFFER SPACE					
V(km/h)	A(m)	L(m)	B(m)	D(m)	
50	50	30	35	8	 SHORT TERM
60	50	40	45	12	
70	75	60	50	15	 LONG TERM
80	100	80	60	15	
90	100	105	65	18	
100	125	125	70	18	

Where:
 V = Posted Speed Limit
 A = Spacing between Signs
 L = Length of Taper
 B = Length of Longitudinal Buffer Space
 D = Spacing between Delineation Devices

30 – MOBILE – LANE CLOSURE

1. EXAMPLE SHOWN

Four-lane – two-way street.

2. CONDITIONS

Mobile/moving jobs are those that are typically done on the move at low speed and may require periodic stopping for only a few minutes duration.

3. OBSERVATIONS

Delineation devices are not required if the operation does not involve stopping

4. SET-UP PROCEDURE

Set-up signage and devices as required.

Commence work.

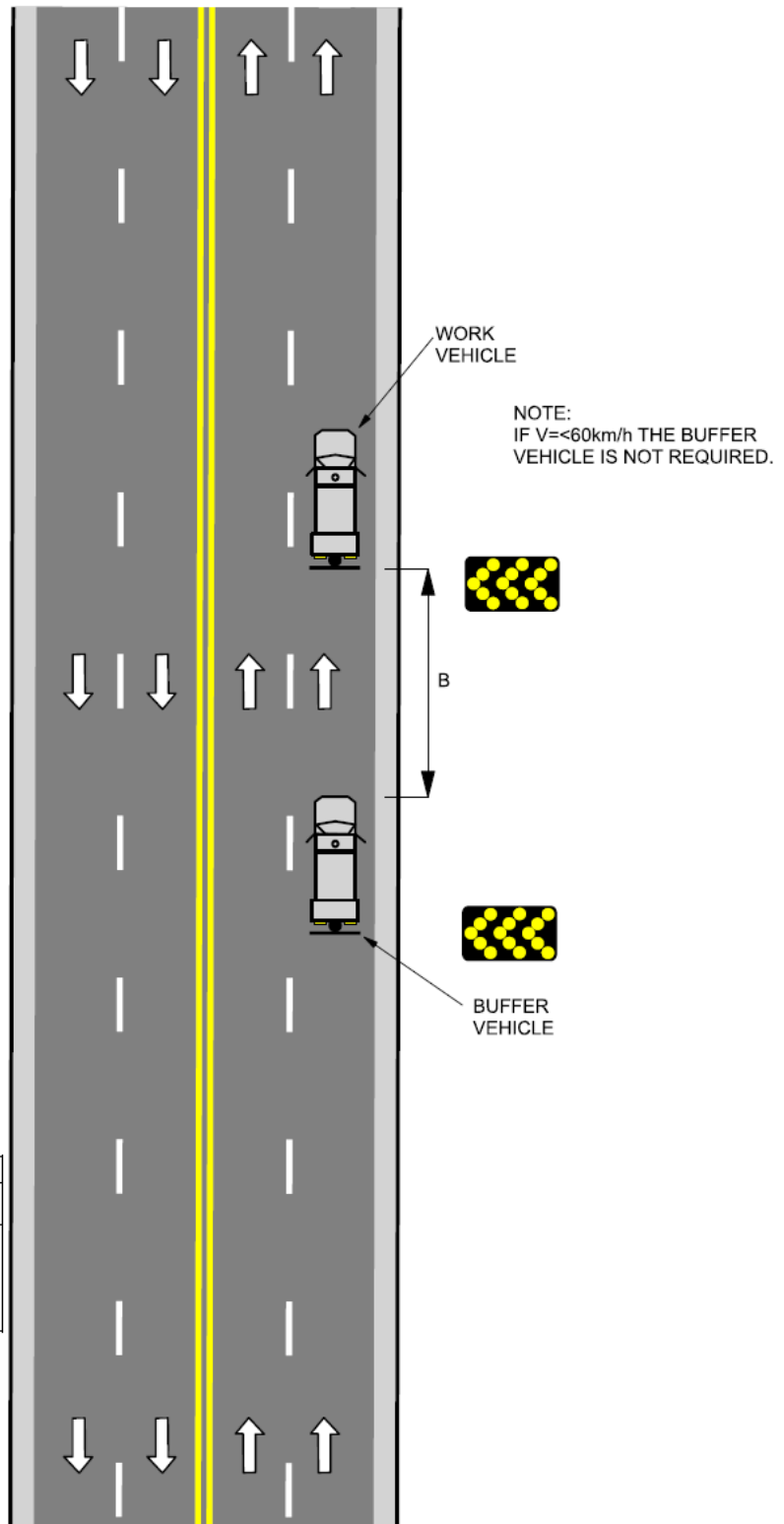

NOTE:
This drawing is a graphical representation of the detour setup. It is NOT drawn to scale.

GUIDELINES FOR LANE CLOSURE TAPERS AND LONGITUDINAL BUFFER SPACE					
V(km/h)	A(m)	L(m)	B(m)	D(m)	
50	50	30	35	8	SHORT TERM
60	50	40	45	12	
70	75	60	50	15	LONG TERM
80	100	80	60	15	
90	100	105	65	18	LONG TERM
100	125	125	70	18	

Where:
V = Posted Speed Limit
A = Spacing between Signs
L = Length of Taper
B = Length of Longitudinal Buffer Space
D = Spacing between Delineation Devices

31 – VERY SHORT DURATION - ENCROACHMENT

1. EXAMPLE SHOWN

Two-lane – two-way street.

2. CONDITIONS

Mobile/moving jobs are those that are typically done on the move at low speed and may require periodic stopping for only a few minutes duration.

3. OBSERVATIONS

Delineation devices are not required if the operation does not involve stopping

4. SET-UP PROCEDURE

Set-up signage and devices as required.

Commence work.

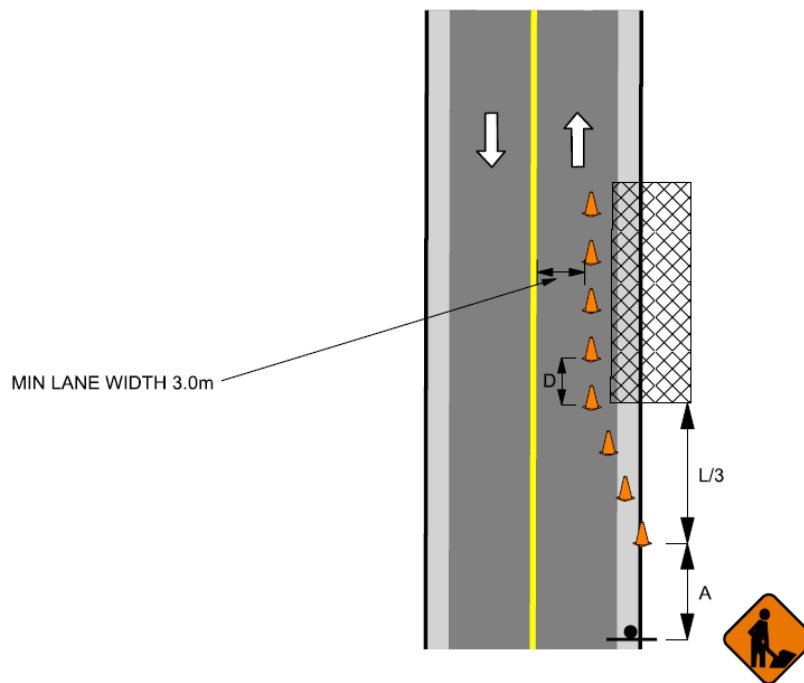

OR

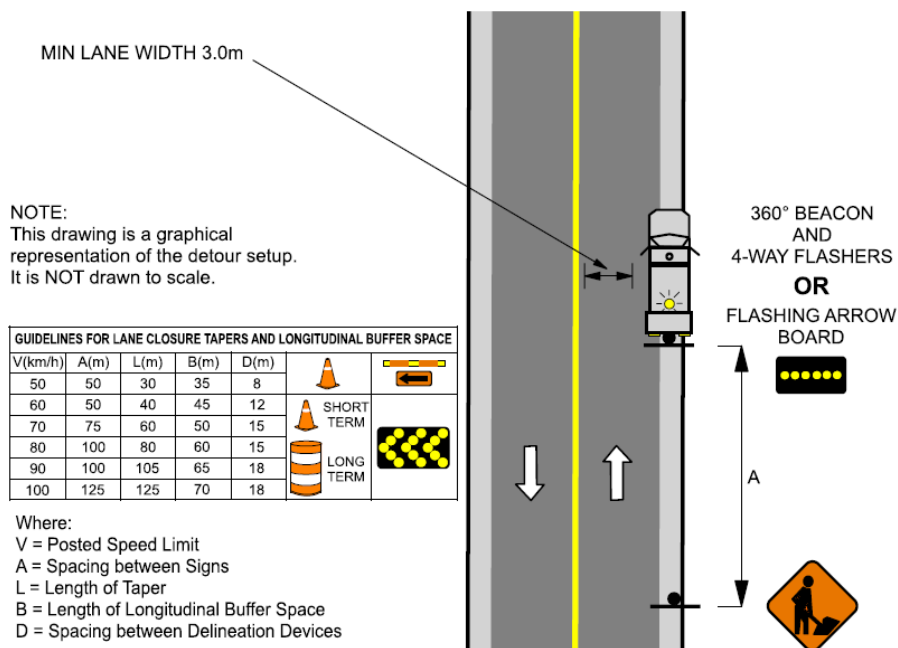

31. VERY SHORT DURATION - SHOULDER WORK

32 – ROAD BRIDGING

1. EXAMPLE SHOWN

Three-lane – one-way street.

2. CONDITIONS

Bridging to be installed for rush hour traffic and during periods of inactivity.

3. OBSERVATIONS

Note bump signs.

Refer to Chapter 3 on bridging for necessary requirements.

Note temporary hazard markers.

4. SET-UP PROCEDURE

All signs to be in place before vehicle traffic allowed on bridging.

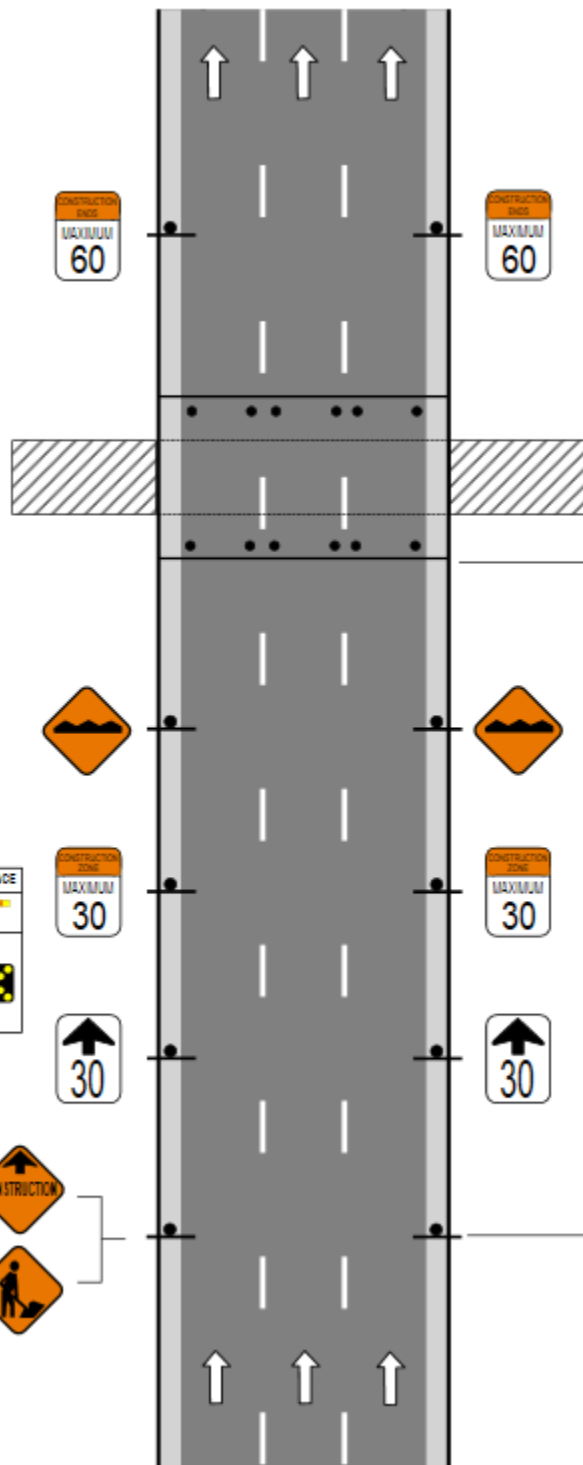

NOTE:
This drawing is a graphical
representation of the detour setup.
It is NOT drawn to scale.

GUIDELINE I FOR LANE CLOSURE TAPER I AND LONGITUDINAL BUFFER SPACE						
V(km/h)	A(m)	L(m)	B(m)	D(m)	SHORT TERM	LONG TERM
50	50	30	35	8		
60	50	40	45	12		
70	75	60	50	15		
80	100	80	60	15		
90	100	105	65	18		
100	125	125	70	18		

Where:
V = Posted Speed Limit
A = Spacing between Signs
L = Length of Taper
B = Length of Longitudinal Buffer Space
D = Spacing between Delineation Devices

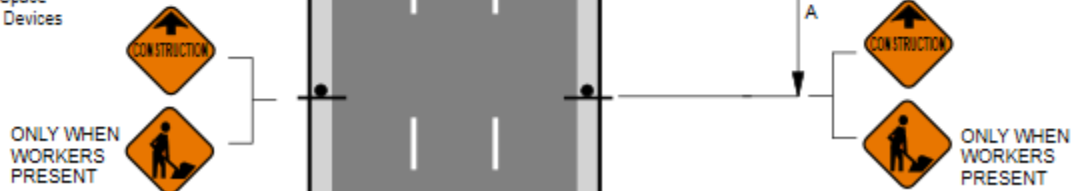

33 – ZIPPER MERGE – LONG DURATION

1. EXAMPLE SHOWN

Four-lane – two-way divided street.

2. CONDITIONS

Long-term single-lane closure

3. OBSERVATIONS

Note that “text” signs may be replaced with a message board.

4. SET-UP PROCEDURE

Start at bottom of diagram. Set-up advance warning signs in order shown.

Set-up taper and outline worksite with cones.

Commence work.

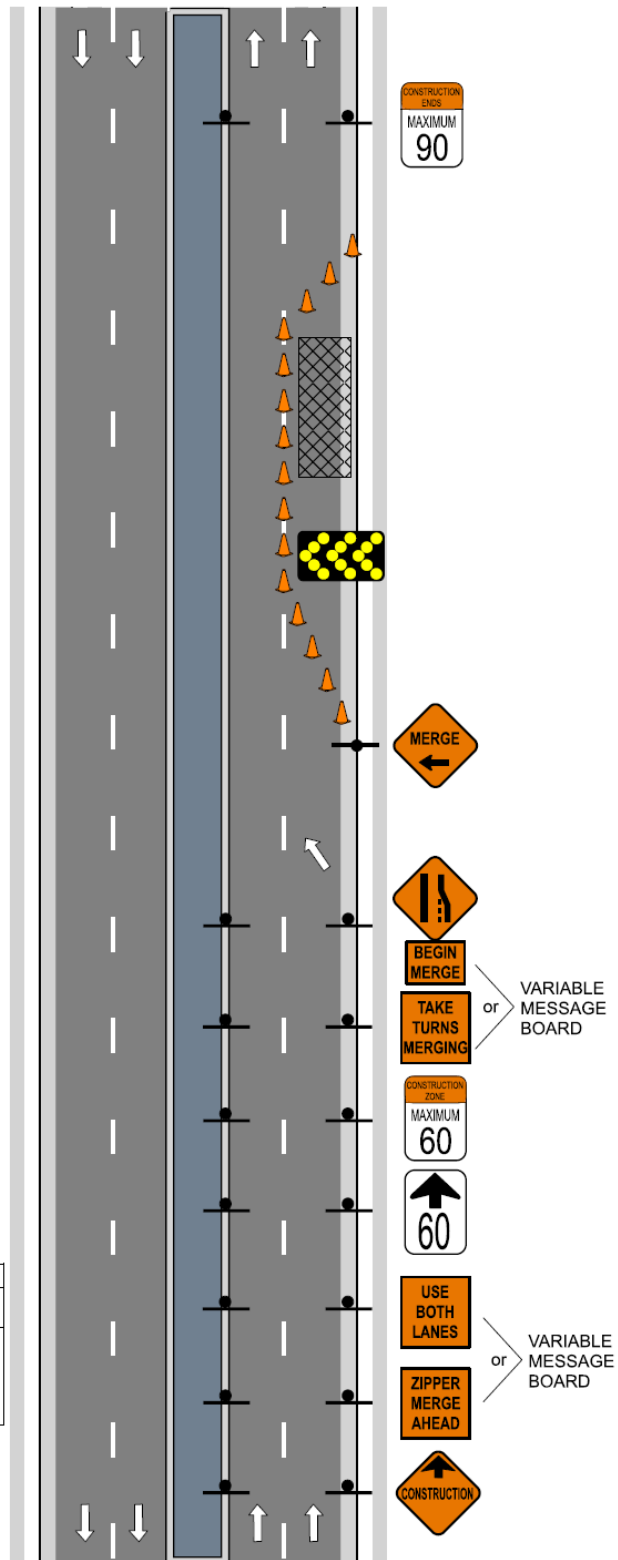

NOTE:
This drawing is a graphical representation of the detour setup. It is NOT drawn to scale.

GUIDELINES FOR LANE CLOSURE TAPERS AND LONGITUDINAL BUFFER SPACE						
V(km/h)	A(m)	L(m)	B(m)	D(m)	SHORT TERM	LONG TERM
50	50	30	35	8		
60	50	40	45	12		
70	75	60	50	15		
80	100	80	60	15		
90	100	105	65	18		
100	125	125	70	18		

Where:
V = Posted Speed Limit
A = Spacing between Signs
L = Length of Taper
B = Length of Longitudinal Buffer Space
D = Spacing between Delineation Devices

33. ZIPPER MERGE – LONG TERM

34 – RAMP CLOSURE

1. EXAMPLE SHOWN

Four-lane – two-way divided street.

2. CONDITIONS

Short-term to Long-term ramp closure

3. OBSERVATIONS

Note that street exit sign should be covered for a long-term closure

4. SET-UP PROCEDURE

Start at bottom of diagram. Set-up advance warning signs in order shown.

Set-up taper and outline worksite with cones.

Commence work.

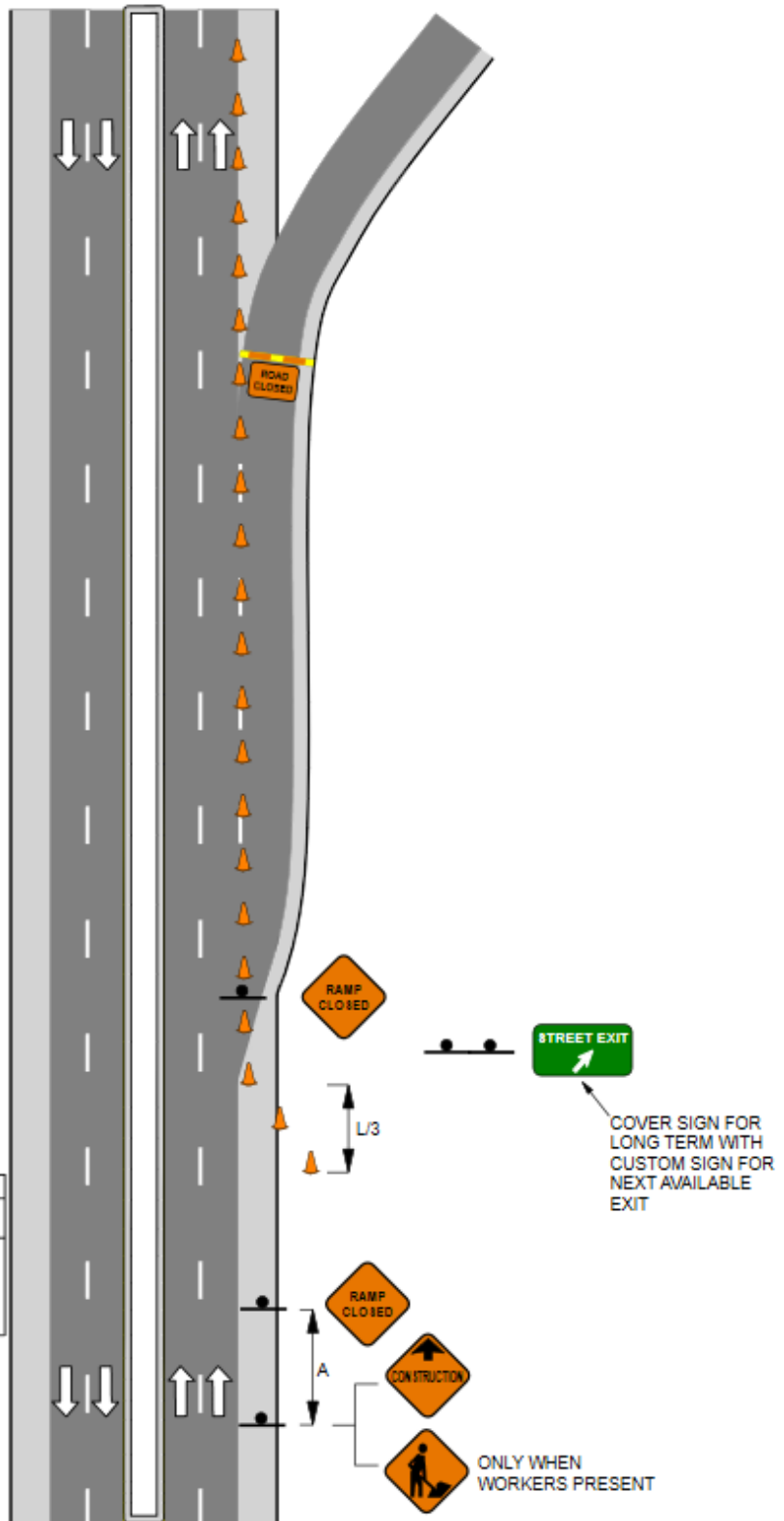

34. RAMP CLOSURE

35 – LANE CLOSED AT RAMP ENTRANCE

1. EXAMPLE SHOWN

Four-lane – two-way divided street.

2. CONDITIONS

Lane closure on ramp.

3. OBSERVATIONS

Note that initial lane closure is not shown here.

4. SET-UP PROCEDURE

Start at bottom of diagram. Set-up advance warning signs in order shown.

Set-up taper and outline worksite with cones.

Commence work.

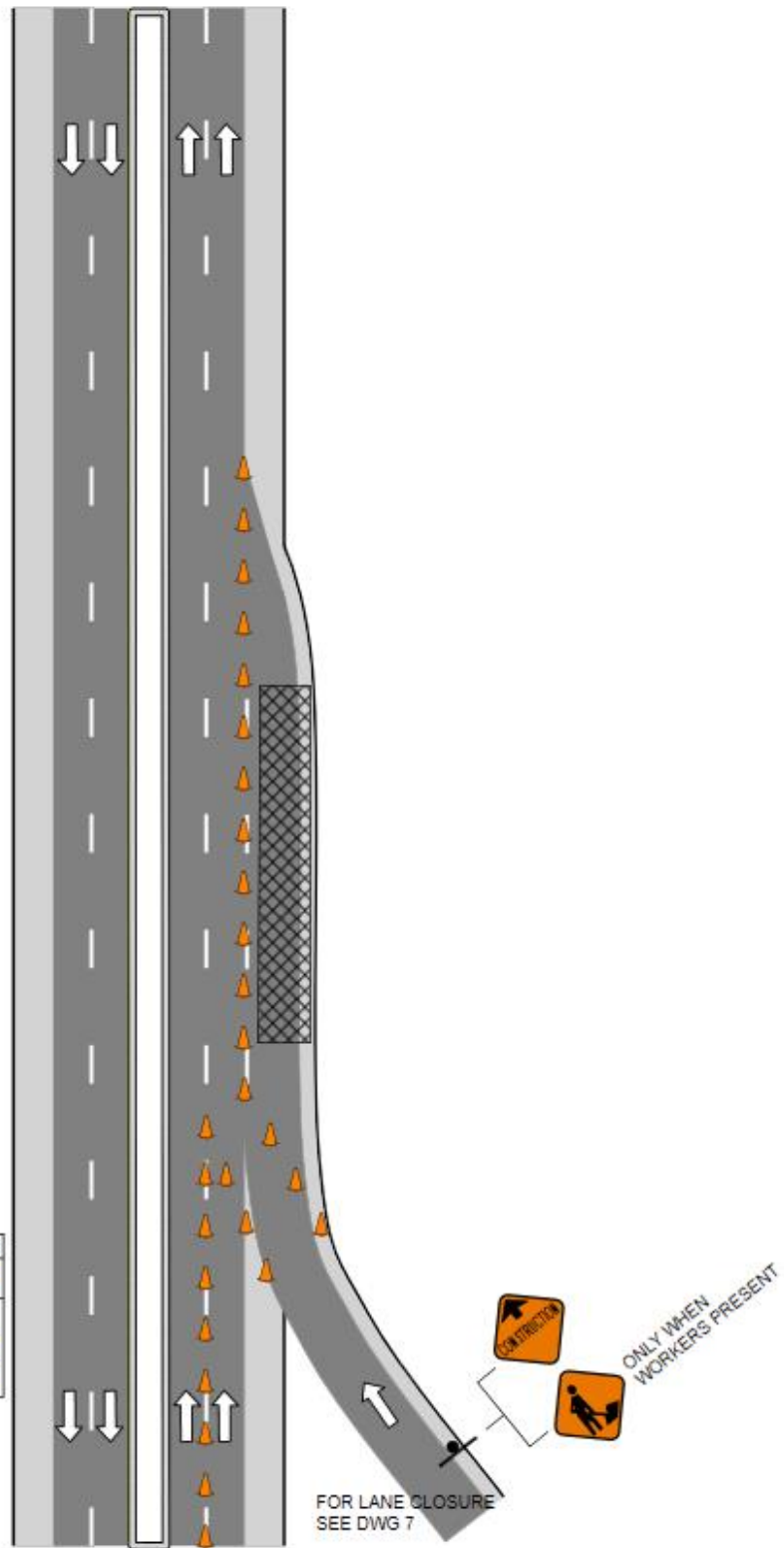

NOTE:
This drawing is a graphical
representation of the detour setup.
It is NOT drawn to scale.

GUIDELINE I FOR LANE CLOSURE TAPER I AND LONGITUDINAL BUFFER SPACE					
V(km/h)	A(m)	L(m)	B(m)	D(m)	
50	50	30	35	8	
60	50	40	45	12	SHORT TERM
70	75	60	50	15	
80	100	80	60	15	LONG TERM
90	100	105	65	18	
100	125	125	70	18	

Where:
V = Posted Speed Limit
A = Spacing between Signs
L = Length of Taper
B = Length of Longitudinal Buffer Space
D = Spacing between Delineation Devices

35. LANE CLOSED AT RAMP ENTRANCE

36 – LANE CLOSED AT RAMP EXIT

1. EXAMPLE SHOWN

Four-lane – two-way divided street.

2. CONDITIONS

Lane closure on ramp.

3. OBSERVATIONS

Note that initial lane closure is not shown here.

4. SET-UP PROCEDURE





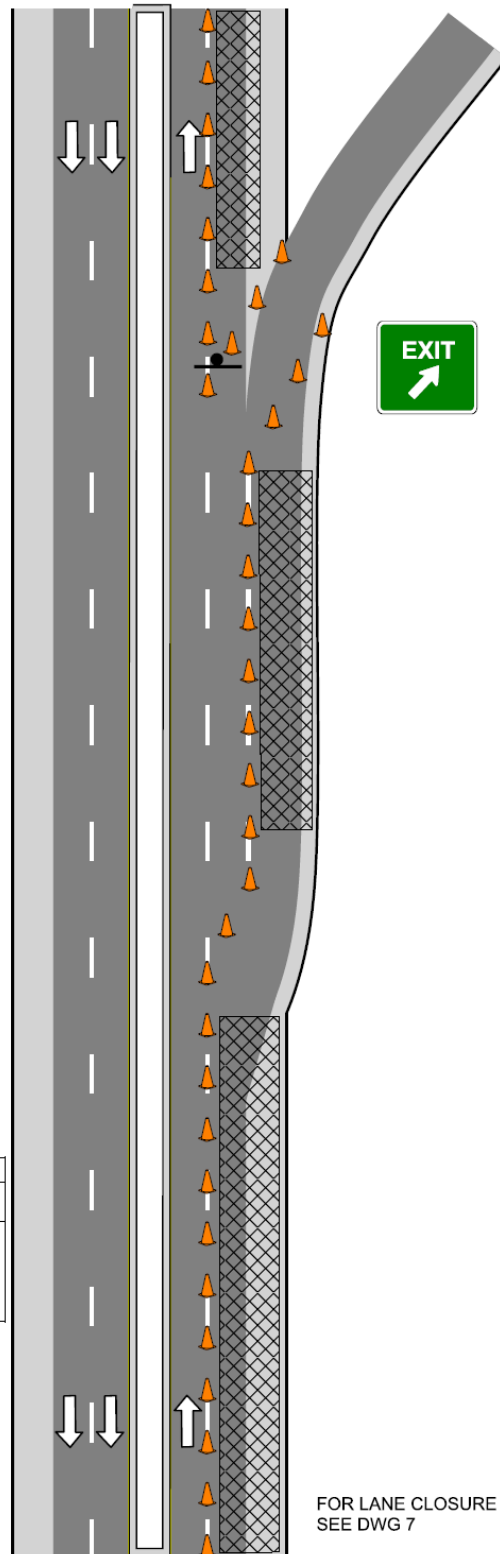

Start at bottom of diagram. Set-up advance warning signs in order shown.

Set-up taper and outline worksite with cones.

Commence work.



NOTE:
This drawing is a graphical
representation of the detour setup.
It is NOT drawn to scale.

GUIDELINES FOR LANE CLOSURE TAPERS AND LONGITUDINAL BUFFER SPACE					
V(km/h)	A(m)	L(m)	B(m)	D(m)	
50	50	30	35	8	
60	50	40	45	12	
70	75	60	60	15	
80	100	80	60	15	
90	100	105	65	18	
100	125	125	70	18	

Where:
V = Posted Speed Limit
A = Spacing between Signs
L = Length of Taper
B = Length of Longitudinal Buffer Space
D = Spacing between Delineation Devices

FOR LANE CLOSURE
SEE DWG 7

36. LANE CLOSED AT RAMP EXIT

37 – BIKE LANE CLOSURE

1. EXAMPLE SHOWN

Three-lane – two-way street.

2. CONDITIONS

Short-term to Long-term bike lane closure

3. OBSERVATIONS

Note closure shown does not encroach into driving lanes

4. SET-UP PROCEDURE

Start at left of diagram. Set-up advance warning sign as shown.

Set-up closure sign.

Commence work.

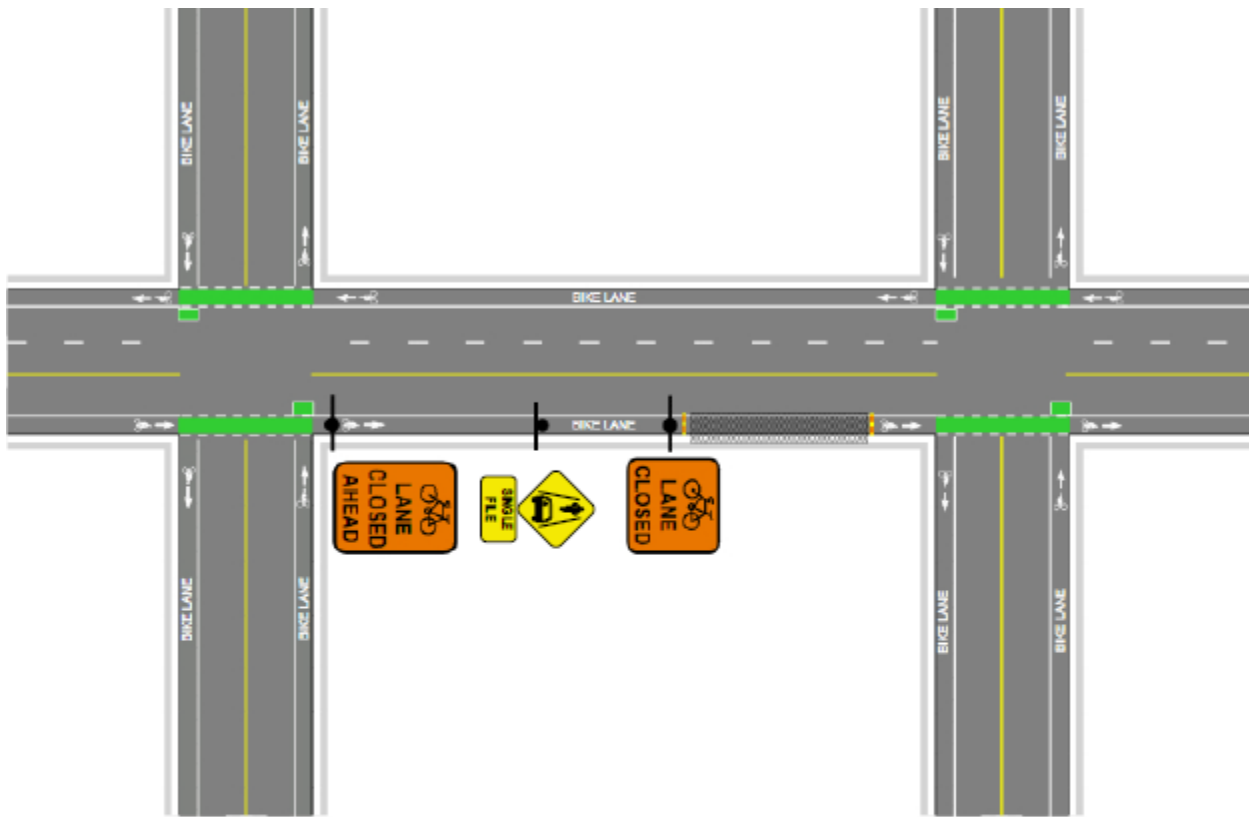

GUIDELINES FOR LANE CLOSURE TAPERS AND LONGITUDINAL BUFFER SPACE						
V(km/h)	A(m)	L(m)	B(m)	D(m)	Signage	Devices
60	60	30	35	8	 SHORT TERM	
60	50	40	45	12		
70	75	60	50	15	 LONG TERM	
80	100	80	60	16		
90	100	105	65	18		
100	125	125	70	18		

NOTE:
This drawing is a graphical representation of the detour setup. It is NOT drawn to scale.

Where:
 V = Posted Speed Limit
 A = Spacing between Signs
 L = Length of Taper
 B = Length of Longitudinal Buffer Space
 D = Spacing between Delineation Devices

37. BIKE LANE CLOSURE

GLOSSARY

Acceleration lane

A lane that enables vehicles to increase speed when merging with through traffic.

Activity Area

The activity area is the section of roadway where the work activity takes place. It is comprised of the work space and the traffic space and may contain one or more buffer spaces.

Advance warning area

In the advance warning area, drivers are informed of what to expect in the downstream work zone or incident area.

Advance warning signs

Signs that give motorists and pedestrians advance notice of disruptions in normal traffic flow. These signs indicate the nature of traffic disruption and the required action on the part of motorists and pedestrians.

Agency or contractor

Any City department, private contractor or public utility agency that has permission and necessary permits to undertake work on, or adjacent to, City of Saskatoon public roadways.

Arrow displays or arrow boards

Flashing arrow displays/boards are traffic control devices that can provide an illuminated flashing display of a left arrow, a right arrow or combination of the left-right arrow, sequencing arrow modes of a bar, which inform the driver to either change lanes or proceed with caution. An arrow display/board shall be used in combination with the appropriate signs, barricades or other traffic control devices.

Arterial

A road primarily for through traffic.

Auxiliary lane

A lane in addition to and placed adjacent to a through lane.

Average daily traffic (ADT)

The total volume of traffic passing through a designated point, in both directions, in one day.

Bike lane

A lane intended for the exclusive use of bicycles, within a roadway used by motorized vehicles.

Breakaway device

A design feature that allows a device such as a sign to yield or separate upon impact.

Bridging

A method to enable vehicles to pass over narrow and shallow trenches by fastening sheet steel to the roadway to form a bridge. It is used at peak congestion times to accommodate traffic when backfilling is not practical.

Buffer space

The buffer space is the area that separates traffic flow from the work activity or a potentially hazardous area and provides recovery space for an errant vehicle. Neither work activity nor storage of equipment, vehicles or material should occur in this space. Buffer spaces may be positioned longitudinally and laterally, with respect to the direction of traffic flow.

Buffer vehicle

A vehicle positioned in a stationary work zone or in a mobile work operation, to provide protection for workers against errant vehicles (also referred to as a shadow vehicle). These vehicles should be equipped with an arrow display/board and a truck-mounted attenuator.

Collector road

A road in which access and traffic movement have similar importance.

Crosswalk

Any part of a roadway specifically intended for pedestrian crossing, which may be so indicated by signs, lines, marking or other devices.

Cyclist

A person riding any cycle, propelled by human effort or a power-assisted device. Once a cyclist dismounts, he/she is considered a pedestrian.

Decision sight distance (DSD)

The distance for a driver to detect a layout, recognize it and maneuver safely.

Delineation devices (or tapering devices)

Devices used to form curves, lines or boundaries that indicate the alignment of the roadway and outline the required vehicle path through the temporary traffic control zone. They include, but are not limited to, cones, drums, vertical panels, tubular markers, barricades and chevrons, and shall be used in combination with or be supplemental to other traffic control devices.

Design speed

A speed selected for purposes of road design.

Detour

A detour is a temporary route where a driver, cyclist or pedestrian is required to depart completely from the normal roadway, sidewalk or pathway to bypass the activity area.

Diversion

Traffic is directed onto a temporary roadway or alignment placed in or next to the ROW.

Downstream

The area past the TTC work zone in the direction of traffic flow.

Emergency Work

Emergency work is defined as that work which should be done immediately. By its nature it cannot be pre-planned; however, standard procedures and requirements shall apply whenever practical.

Expressway

A divided arterial roadway for through traffic with full or partial control of access and with some interchanges. Posted speeds are typically less than or equal to 80km/h.

Freeway

A multi-lane divided highway with a minimum of two lanes for the exclusive use of traffic in each direction and full control of access without traffic interruption. Posted speeds are typically greater than or equal to 90km/h.

Gore area

An area of pavement delineated by paint lines or delineation devices, between the edge line of the through road and the entry or exit ramp.

Hoarding

A form of fencing or barrier or combination of these, designed to separate pedestrians and/or motorists from a construction site.

Impact Attenuators

A device (also known as crash cushions) that prevents an errant vehicle from impacting a fixed object by safe, controlled deceleration. Impact attenuators in temporary traffic control zones protect motorists from the exposed ends of barriers, fixed objects and other hazards.

Intersection sight distance (ISD)

The line of sight between intersecting roadways.

Lateral buffer space

A lateral buffer space is used to separate the traffic space from the work space, or a potentially hazardous area, such as an excavation or pavement drop-off. The width of the lateral buffer space should be determined by engineering judgement.

Longitudinal barrier

A barrier whose primary function is to prevent a collision and redirect an errant vehicle.

Longitudinal buffer space

The longitudinal buffer space is placed in the initial position of a closed lane in advance of the work space.

May

A permissive condition.

Median

A reserve, including shoulders between through lanes.

Multi-Use Pathway

A bicycle and pedestrian facility physically separated from roadways, where motor vehicle traffic, except maintenance vehicles, is excluded.

Variable message boards (portable changeable message signs)

Traffic control devices with the flexibility to display a variety of messages.

On-street bike route

A roadway signed specifically to encourage bicycle use.

Pedestrian

A person walking or jogging, using a wheelchair or mobility aid, walking a dog, travelling with a child's stroller, in-line skates or a skateboard.

Regulatory sign

Signs used to identify a traffic regulation that is applicable at a given time or place on a road and to identify the legal requirements.

Rigid Barrier

A form of longitudinal barrier that is intended to redirect an errant vehicle with minimum deflection. It usually consists of a continuous concrete mass (i.e. a concrete, safety shaped barrier, such as the New Jersey barrier)

Semi-Rigid Barrier

A form of longitudinal barrier intended to redirect an errant vehicle by rail tension and bending. Examples are the blocked W-Beam or Thrie-Beam.

Shall

A mandatory requirement.

Should

An advisory requirement.

Sidewalk

A travelled way intended for pedestrian use, following an alignment generally parallel to that of the adjacent roadway.

Stopping distance

The distance travelled by a vehicle from the instant the driver decides to stop until stopped.

Stopping sight distance (SSD)

The distance between vehicle and object for which the driver decides to stop, from the instant the object comes in to view. This includes the distance travelled during perception and reaction times plus the breaking distance.

Tangent

A straight section of roadway. In TTC set-ups it is the distance between the end of one taper and the beginning of the next.

Taper

The gradual narrowing of a lane using channelization devices, intended to safely guide drivers into the adjacent lane. The following identify the various types of tapers used in temporary traffic control.

- **Merging taper**
A merging taper requires drivers to merge with an adjacent lane of traffic. The taper should be long enough to enable drivers to adjust their speeds and merge into a single lane before the end of the transition. A merging taper requires a full lane shift.
- **One-lane, two-way (traffic) taper**
The one-lane, two-way traffic taper is used where the portion of road is used alternately by traffic in each direction.

- **Shifting taper**
A Shifting taper is used where a lateral shift (not a full lane merge/diverge) is required and includes a parallel lane shift (lane encroachment) or a shoulder shift taper (shoulder encroachment)
- **Shoulder taper**
A shoulder taper can be used on roadways with improvised shoulders that may be mistaken for driving lanes.
- **Termination (downstream) taper**
The downstream taper may be useful in termination areas to provide a visual clue to the driver that access is available to the original lane path that was closed.

Temporary traffic control (TTC)

Provides for the movement of vehicles, bicycles, pedestrian traffic and public transit, when the normal function of a roadway is suspended.

Termination area

Is used for traffic to make the transition back to the normal path of the road. It extends downstream from the end of the work space to the point where normal speed resumes.

Traffic control person (TCP)

A trained and certified person responsible for controlling traffic.

Transition area

The section of roadway where road users are redirected from their normal path.

Traffic Control Devices

Devices to direct vehicle and pedestrian movement through an area in which normal traffic flow has been disrupted. This includes all signs, delineators, barricades and arrow boards.

Traffic Control Zone

The zone where normal traffic flow is disrupted by guiding traffic around an obstruction. This zone includes the work area and all areas affected by temporary traffic control devices.

Transition Area

When redirection of the drivers' normal path is required, traffic must be channelled from the normal path to a new path. This redirection is intended to occur at the beginning of the transition area.

Truck-mounted attenuator

An energy absorbing device mounted on the rear of a crash truck to deform on impact in a controlled manner.

Upstream

The area before the TTC work zone in the direction of traffic flow.

Warning signs

Warning signs providing advance notice of conditions on or adjacent to a road that will normally require a reduction in speed.

Work site or work area

The area around which traffic is being diverted to enable work to be done. It is usually on one or more sides by traffic control set-up. It includes an area for use of equipment, stockpiling materials and the excavation or building site

TEMPORARY TRAFFIC CONTROL CHECKLIST				
BEFORE THE JOB		YES	NO	N/A
1	Has the Transportation Division approved your work and traffic accommodation plan			
2	Do you need assistance from the Detour Group, Transportation, for temporary traffic control			
3	Do you have the necessary permits (ROW permit)			
4	Is a tree protection plan required			
5	Do you require a temporary parking accommodation plan			
6	Have you contacted Saskatoon Transit if you are working on a bus route			
7	Have you given adequate notice of the planned work to the affected businesses, utilities and residents			
8	Are the proper temporary traffic devices available at the worksite to accommodate traffic			
9	Are the pedestrians and motorists properly separated and protected from each other and the work site			
10	Have you done everything to ensure emergency access			
DURING THE JOB		YES	NO	N/A
1	Is there enough proper equipment available to secure the worksite overnight if necessary			
2	Are all the traffic control devices in their proper place and maintained properly			
3	If a Traffic Control Person is being use, do they have the proper accreditation			
4	Does the traffic set-up continue to meet your needs. If not, contact the Detour Group			
5	Is the work zone being monitored as specified			
6	Do you have an approved contingency plan to accommodate peak hour traffic			
7	Have arrangements been made for paving materials to bring the ROW back into service			
AFTER THE JOB		YES	NO	N/A
1	Have you obtained approval to reopen the roadway			
2	Have you cleaned up the work site and rehabilitated the ROW to a condition equal or better than when work started			
3	Have arrangements been made to restore or rehabilitate the ROW			
4	Have you removed all temporary traffic control devices			

Lane Designations

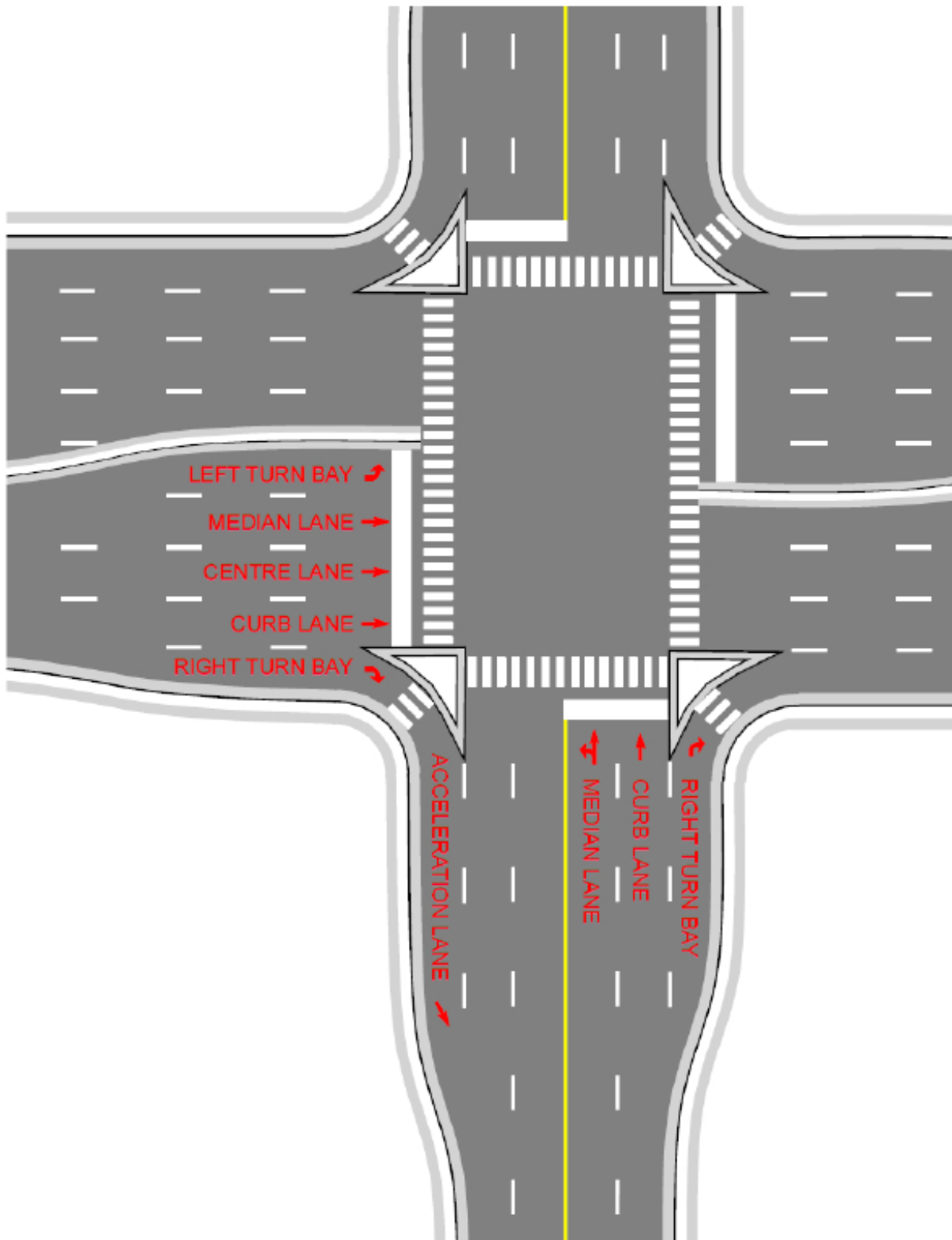

TRAFFIC BYLAW 7200

In May, 2017 an amendment was passed to The **Traffic Bylaw (7200)** giving Bylaw Officers and members of the Saskatoon Police Service the ability to enforce bylaw permit requirements for the private use of a public right of way (ROW).

Effective immediately, failure to provide proof of permit upon request may result in fines being issued for non-compliance. Over the next few months, Bylaw Officers will work with the community, providing education on the amended bylaw and the penalties associated with it.



Some of the more frequent bylaw infractions and the new accompanying fines are listed on the back of this page. For a full list of infractions and to see the **Traffic Bylaw 7200** on the City of Saskatoon website please visit Saskatoon.ca/ROW

Examples of new fines for non-authorized private use of the public ROW are listed on the back of this card.

TRAFFIC BYLAW 7200

Unauthorized material on street	This may include yard waste, basketball stands and hockey nets.	\$500
Use of street or ROW without a permit	This may include storage of items including landscaping materials, bricks or gravel. This may include setting up unpermitted detours.	\$500
Unauthorized use of sidewalk or boulevard as access for vehicles or machinery	This may include driving vehicles over sidewalks, square curbs or boulevards.	\$500
Allowing material to enter street	This may include directing sump pump or eavestrough water from private properties and overgrown vegetation originating on private property.	\$250
Unlicensed vehicles parked on streets and right-of-way		\$50
Repairing Vehicle on Street		\$50/\$30
Unlawful use of boulevard	This includes the parking of vehicles, unattached trailers or machinery.	\$50
Tracking mud/gravel/dirt/material onto streets		\$250



Saskatoon.ca/ROW