



December 7, 2017

CITY OF SASKATOON

Asbestos-Containing Building Materials Assessment Report - Waste Water Digester Building and Digesters



REPORT

Submitted to:

The City of Saskatoon
1101 Avenue P North
Saskatoon, SK S7L 7K6

Report Number: 1667963

Distribution:

One Copy: City of Saskatoon
One Copy: Golder Associates Ltd.





Table of Contents

1.0 INTRODUCTION	1
2.0 SCOPE OF WORK	1
2.1 Asbestos-Containing Materials	1
3.0 RESULTS AND DISCUSSION	2
3.1 Asbestos-Containing Materials	2
3.1.1 List of Identified Asbestos-Containing Materials	2
3.1.2 Non Asbestos-Containing Materials	3
4.0 EXCLUDED AREAS AND MATERIALS	3
5.0 CONCLUSIONS AND RECOMMENDATIONS	4
5.1 Asbestos-Containing Materials	4
6.0 SURVEY LIMITATIONS	5
7.0 CLOSURE	5

APPENDICES

APPENDIX A

Laboratory Certificate of Analysis Report

APPENDIX B

Site Photographs

APPENDIX C

Waste Water Digester Building and Digesters Room by Room Spreadsheet

APPENDIX D

Floor Plans



ASBESTOS-CONTAINING BUILDING MATERIALS ASSESSMENT REPORT - WASTE WATER DIGESTER BUILDING AND DIGESTERS

1.0 INTRODUCTION

Golder Associates Ltd. (Golder) was retained by the City of Saskatoon (the Client) to conduct an asbestos-containing building materials assessment of the Waste Water Digester Building and Digesters (the Site) located at 470 Whiteswan Drive in Saskatoon, Saskatchewan. This assessment report details our findings, conclusions and recommendations for the Site. A walkthrough of the Site was conducted on June 22, 2017, by Kody Henderson, OHS Project Manager, and the assessment was conducted on October 12, 2017 by Scott Bishop, Junior Occupational Hygienist. Asbestos-containing building materials were identified within the Waste Water Digester Building and Digesters during the assessment. Further information is provided in Section 3.0.

2.0 SCOPE OF WORK

In accordance with Tender 16-0844, Golder's scope of work included conducting an asbestos-containing building materials assessment of the Site to evaluate the quantities, locations, and conditions of asbestos-containing building materials.

Following the field work, Golder prepared this assessment report that includes laboratory analysis results, findings of the assessment, conclusions, and recommendations.

2.1 Asbestos-Containing Materials

The assessment involved a non-destructive inspection of the Site to assess the type and extent of suspect ACMs in the facility. The systems that were reviewed as part of the inspections included, but were not limited to:

- *Structural* - systems including: insulation between solid webbed joists, fireproofing, building envelope, and interior/exterior caulking around windows and doors;
- *Mechanical* - systems insulation including: hot water and steam system, condensate system, chilled water system, glycol system, domestic hot and cold water, emergency generator exhaust, boiler units, heat exchangers, and asbestos cement piping; and
- *Architectural* - systems including: texture coats, sheet flooring, vinyl floor tile, acoustical spray-applied materials, condensation control applications, ceiling tile, wall board, drywall joint compound, and asbestos sheet products.

Systematic sampling of suspect ACMs was conducted as part of the assessment. Samples were submitted under chain of custody to International Asbestos Testing Laboratory Inc. (IATL) and analyzed for asbestos type and percentage content using Polarized Light Microscopy (PLM) in accordance with EPA methodologies (EPA 600/R-93/116).

Further information related to the assessment and sample collection methods can be found in the Golder document *Golder Asbestos Assessment General Survey Plan and Protocol* provided to the Client.



3.0 RESULTS AND DISCUSSION

The Waste Water Digester Building and Digesters consists of open equipment rooms and the Digesters, and was constructed in 1971. During the assessment, the Waste Water Digester Building and Digesters were treated as two functional spaces. One functional space consisted of the equipment rooms throughout the Digester Building and the second functional space consisted of the exterior of the Digesters. The interior of the Digesters was not assessed for potential asbestos-containing materials due to health and safety, operational, and confined space concerns.

- The Laboratory Certificate of Analysis report for the bulk asbestos samples is included in Appendix A.
- Photographs collected during the assessment are provided in Appendix B.
- A room by room spreadsheet outlining the locations, quantities, friability, and condition of identified asbestos-containing materials as well as additional information is provided in Appendix C.
- Floor plans outlining the sample locations and locations of identified asbestos-containing materials are provided in Appendix D.
- Please refer to Sections 4.0 and 6.0 of this report for a summary of the limitations encountered.

3.1 Asbestos-Containing Materials

A total of twenty-three (23) samples of building materials were collected and tested for asbestos content during the assessment of the Waste Water Digester Building and Digesters. Two (2) of the samples were found to contain asbestos.

Potential asbestos-containing materials and components may be located within the electrical panels on Site.

3.1.1 List of Identified Asbestos-Containing Materials

A list of the identified asbestos-containing materials is provided below.

- Cast iron joint packing; and,
- Exterior black window caulking.

Further information on the identified asbestos-containing materials listed is provided below.

Cast Iron Joint Packing

One (1) sample of cast iron joint packing was collected during the assessment. The sample collected was found to contain 30% Amosite asbestos. Asbestos-containing cast iron joint packing (see Photograph 1 in Appendix B) was observed in the following locations:

- Basement (approximately one joint).

Other cast iron joint packing observed throughout the building was suspected to be lead-packing.



Exterior Black Window Caulking

One (1) sample of exterior black window caulking was collected during the assessment. The sample collected was found to contain 20% Chrysotile asbestos. Asbestos-containing black window caulking (see Photograph 2 in Appendix B) was observed in the following locations:

- Exterior (approximately 850 linear ft.)

3.1.2 Non Asbestos-Containing Materials

The following materials were sampled during this assessment and were found to not contain asbestos or were observed to be non-suspect materials:

- Pipe-fitting insulation;
- Concrete floor skim coat;
- Brown window caulking;
- Grey expansion joint caulking;
- Red firestop;
- Grey duct mastic;
- Black door frame caulking;
- Grey firestop;
- Suspected lead-packing in cast iron joints;
- Exterior light grey expansion joint caulking;
- Exterior brown window caulking; and
- Exterior brick mortar.

4.0 EXCLUDED AREAS AND MATERIALS

The following is a list of the areas and/or materials excluded during the assessment.

- Building materials accessible by a ten-foot ladder were assessed by Golder during the assessment. Materials located at heights that were inaccessible from a ten-foot ladder were not assessed. If materials at heights are to be removed or impacted by future renovation or demolition activities, additional investigation and sampling of suspect materials may be required.
- The roof and associated components were not assessed by Golder during the assessment as per Tender 16-0844. If the roof and associated components are to be removed or impacted by future renovation or demolition activities, additional investigation and sampling of suspect materials may be required.
- The electrical panels and associated components were not inspected by Golder during the assessment. If the panels are to be removed or impacted by future renovation or demolition activities, additional investigation and sampling of suspect materials may be required.



- The fire doors were not assessed by Golder during the assessment. If the fire doors are to be removed or impacted by future renovation or demolition activities, additional coring, investigation and sampling of suspect materials may be required.

5.0 CONCLUSIONS AND RECOMMENDATIONS

Based on the visual assessment and the laboratory analytical results, the following project specific conclusions and recommendations are provided.

5.1 Asbestos-Containing Materials

Asbestos was positively identified within the cast iron joint packing and exterior black window caulking on Site. Asbestos was not identified in the remaining samples collected and analyzed.

If the building is scheduled for renovations that will impact the identified asbestos-containing materials, it must be removed. If additional suspect asbestos-containing building materials are encountered during renovation activities, additional sampling should be undertaken to evaluate asbestos content.

Removal work should be completed by workers that are adequately trained in the hazards and proper methods of working with asbestos. Throughout the abatement activities, appropriate air monitoring and inspections should be conducted by a competent person to document that contamination is contained and that ACM are disposed of appropriately. Ensure asbestos waste is disposed of in accordance with the requirements of the Government of Saskatchewan.

All quantities listed in the report are approximate and are based on the conditions at the time of the assessment. Prior to abatement work it is recommended that a competent person conduct a review of the site to quantify and obtain all measurements of all building materials detailed in this report for cost estimating purposes.

In anticipation of potential abatement, Golder's recommendations for the asbestos-containing materials identified during the assessment are outlined below.

Cast Iron Joint Packing

If scheduled for impact, asbestos-containing cast iron joint caulking should be abated following moderate-risk glovebag or high-risk abatement work procedures as outlined in the *Saskatchewan Asbestos Abatement Manual* (2017). Alternatively, as the joint packing was observed in good condition, and with a priority rating of 5 (please see the room by room spreadsheet provided in Appendix C for a description of the priority ratings), the packing can be managed in place if not scheduled for impact.

Exterior Black Window Caulking

If scheduled for impact, asbestos-containing black window caulking should be abated following low-risk abatement work procedures as outlined in the *Saskatchewan Asbestos Abatement Manual* (2017). Alternatively, as the caulking was observed in good condition, and with a priority rating of 5 (please see the room by room spreadsheet provided in Appendix C for a description of the priority ratings), the caulking can be managed in place if not scheduled for impact.



ASBESTOS-CONTAINING BUILDING MATERIALS ASSESSMENT REPORT - WASTE WATER DIGESTER BUILDING AND DIGESTERS

6.0 SURVEY LIMITATIONS

This report is based on data and information collected by Golder during the assessment conducted on October 12, 2017 and is based solely on site conditions encountered at the time of the assessment. Any use of this document or the findings, conclusions or recommendations provided in this report by any person other than the City of Saskatoon is at the sole risk of such user.

The conclusions and recommendations contained in this survey report are based upon professional opinions with regard to the subject matter. These opinions are in accordance with currently accepted environmental assessment standards and practices applicable to these locations and are subject to the following inherent limitations:

The data and findings presented in this report are valid as of the dates of the investigations. The passage of time, manifestation of latent conditions or occurrence of future events may warrant further exploration at the properties, analysis of the data, and re-evaluation of the findings, observations, and conclusions expressed in this report. No assurance is made regarding changes in conditions or practices subsequent to the time of the investigation. It was beyond the scope of this assessment to conduct a risk assessment and the potential health risks that may be associated with asbestos exposure for building occupants.

The data reported and the findings, observations and conclusions expressed in this report are limited by the Scope of Work. The Scope of Work was defined by Tender 16-0844 and the initial site walkthrough with the Client, the time and budgetary constraints imposed by the Client, and availability of access to the property.

Because of the limitations stated above, the findings, observations and conclusions expressed by Golder in this report are not, and must not be, considered an opinion concerning compliance of any past or present owner or operator of the site with any federal, provincial or local laws or regulations.

No warranty or guarantee, whether expressed or implied, is made with respect to the data or the reported findings, observations, and conclusions, which are based solely upon site conditions in existence at the time of investigation.

Golder's assessment reports present professional opinions and findings of a scientific and technical nature. While attempts were made to relate the data and findings to applicable environmental laws and regulations, the report shall not be construed to offer legal opinion or representations as to the requirements of, nor compliance with, environmental laws, rules, regulations or policies of federal, provincial, or local governmental agencies. Any use of the survey report constitutes acceptance of the limits of Golder's liability.

Golder's liability extends only to its client and not to other parties who may obtain this survey report. Issues raised by the report must be reviewed by appropriate legal counsel.

7.0 CLOSURE

We trust the information presented in this report meets your requirements. If you have any questions, please contact Kody Henderson at (780) 483-3499 or email at kody_henderson@golder.com. Thank you for the opportunity to be of service. We look forward to working with you again in the future.



Report Signature Page

GOLDER ASSOCIATES LTD.

Prepared by:

Scott Bishop, B.A.
Junior Occupational Hygienist

Reviewed by:

Kody Henderson, Dipl. Env. Sci., CRSP
OHS Project Manager

Andrew Grant, B.Sc., P.Eng., EP, CRSP
Associate, OHS Project Director

SWB/KH/AG/ba

Golder, Golder Associates and the GA globe design are trademarks of Golder Associates Corporation.

\\golder\gal\edmonton\active\2016\3 proj\1667963 cityofsaskatoon_asbsurveys_saskatoon\07 reports\56 - wastewater digester bldgs and digesters\city of saskatoon - ww digester building - asbestos building material assessment report.docx



APPENDIX A

Laboratory Certificate of Analysis Report

CERTIFICATE OF ANALYSIS

Client: Golder Associates Ltd 16820 107 Ave Edmonton AB T5P 4C3	Report Date: 10/27/2017 Report No.: 550053 - PLM Project: Digester Bldg Project No.: 1667963	Rev #2, 10/30/2017
Client: GOL572		

PLM BULK SAMPLE ANALYSIS SUMMARY

Lab No.: 6368201 Client No.: A-001	Analyst Observation: Off-White Insulation Client Description: Pipe Fitting Insulation	Location: Basement Facility:
<u>Percent Asbestos:</u> <i>None Detected</i>	<u>Percent Non-Asbestos Fibrous Material:</u> Trace Other 50 Mineral Wool	<u>Percent Non-Fibrous Material:</u> 50

Lab No.: 6368202 Client No.: A-002	Analyst Observation: Tan Non-Fibrous Client Description: Concrete Skim Coat	Location: Basement Facility:
<u>Percent Asbestos:</u> <i>None Detected</i>	<u>Percent Non-Asbestos Fibrous Material:</u> None Detected	<u>Percent Non-Fibrous Material:</u> 100

Lab No.: 6368203 Client No.: A-003	Analyst Observation: Off-White Insulation Client Description: Pipe Fitting Insulation	Location: Basement Facility:
<u>Percent Asbestos:</u> <i>None Detected</i>	<u>Percent Non-Asbestos Fibrous Material:</u> 20 Cellulose	<u>Percent Non-Fibrous Material:</u> 80

Lab No.: 6368204 Client No.: A-004	Analyst Observation: White/Green/Off-White Wrap / Insulation Client Description: Pipe Fitting Insulation	Location: Basement Facility:
<u>Percent Asbestos:</u> <i>None Detected</i>	<u>Percent Non-Asbestos Fibrous Material:</u> 20 Cellulose 30 Mineral Wool	<u>Percent Non-Fibrous Material:</u> 50

Lab No.: 6368205 Client No.: A-005	Analyst Observation: Grey/Tan Non-Fibrous Client Description: Concrete Skim Coat	Location: Stairwell Facility:
<u>Percent Asbestos:</u> <i>None Detected</i>	<u>Percent Non-Asbestos Fibrous Material:</u> None Detected	<u>Percent Non-Fibrous Material:</u> 100

Lab No.: 6368206 Client No.: A-006	Analyst Observation: Brown Caulk Client Description: Brown Window Caulking	Location: Main Floor Facility:
<u>Percent Asbestos:</u> <i>None Detected</i>	<u>Percent Non-Asbestos Fibrous Material:</u> None Detected	<u>Percent Non-Fibrous Material:</u> 100

Analytical Method -US EPA 600, R93-116. Please refer to the Appendix of this report for further information regarding your analysis.

Date Received: 10/18/2017
Date Analyzed: 10/27/2017
Signature: 
Analyst: Linda Price

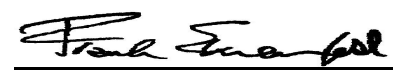
Approved By: 
Frank E. Ehrenfeld, III
Laboratory Director

CERTIFICATE OF ANALYSIS

Client: Golder Associates Ltd
16820 107 Ave
Edmonton AB T5P 4C3

Report Date: 10/27/2017
Report No.: 550053 - PLM
Project: Digester Bldg
Project No.: 1667963

Rev #2, 10/30/2017

Client: GOL572

PLM BULK SAMPLE ANALYSIS SUMMARY

Lab No.: 6368207 **Analyst Observation:** Grey Caulk **Location:** Main Floor
Client No.: A-007 **Client Description:** Grey Expansion Joint Caulking **Facility:**
Percent Asbestos: Percent Non-Asbestos Fibrous Material: Percent Non-Fibrous Material:
None Detected None Detected 100

Lab No.: 6368208 **Analyst Observation:** Red Insulation **Location:** Main Floor
Client No.: A-008 **Client Description:** Red Firestop **Facility:**
Percent Asbestos: Percent Non-Asbestos Fibrous Material: Percent Non-Fibrous Material:
None Detected None Detected 100

Lab No.: 6368209 **Analyst Observation:** Grey Insulation **Location:** Second Floor
Client No.: A-009 **Client Description:** Pipe Fitting Insulation **Facility:**
Percent Asbestos: Percent Non-Asbestos Fibrous Material: Percent Non-Fibrous Material:
None Detected 60 Mineral Wool 40

Lab No.: 6368210 **Analyst Observation:** Grey Mastic **Location:** MCC
Client No.: A-010 **Client Description:** Grey Duct Mastic **Facility:**
Percent Asbestos: Percent Non-Asbestos Fibrous Material: Percent Non-Fibrous Material:
None Detected None Detected 100

Lab No.: 6368211 **Analyst Observation:** Black Caulk **Location:** MCC
Client No.: A-011 **Client Description:** Black Door Caulking **Facility:**
Percent Asbestos: Percent Non-Asbestos Fibrous Material: Percent Non-Fibrous Material:
None Detected None Detected 100

Lab No.: 6368212 **Analyst Observation:** Grey/Tan Non-Fibrous **Location:** Stairwell
Client No.: A-012 **Client Description:** Concrete Skim Coat **Facility:**
Percent Asbestos: Percent Non-Asbestos Fibrous Material: Percent Non-Fibrous Material:
None Detected None Detected 100

Analytical Method -US EPA 600, R93-116. Please refer to the Appendix of this report for further information regarding your analysis.

Date Received: 10/18/2017
Date Analyzed: 10/27/2017
Signature: 
Analyst: Linda Price

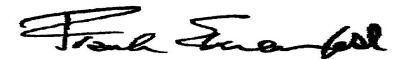
Approved By: 
Frank E. Ehrenfeld, III
Laboratory Director

CERTIFICATE OF ANALYSIS

Client: Golder Associates Ltd 16820 107 Ave Edmonton AB T5P 4C3	Report Date: 10/27/2017 Report No.: 550053 - PLM Project: Digester Bldg Project No.: 1667963	Rev #2, 10/30/2017
Client: GOL572		

PLM BULK SAMPLE ANALYSIS SUMMARY

Lab No.: 6368213 Client No.: A-013	Analyst Observation: Grey Fibrous Client Description: Cast Iron Joint Packing	Location: Basement Facility:
<u>Percent Asbestos:</u> 30 Amosite	<u>Percent Non-Asbestos Fibrous Material:</u> None Detected	<u>Percent Non-Fibrous Material:</u> 70

Lab No.: 6368214 Client No.: A-014	Analyst Observation: Grey Insulation Client Description: Grey Firestop	Location: Stairwell Facility:
<u>Percent Asbestos:</u> <i>None Detected</i>	<u>Percent Non-Asbestos Fibrous Material:</u> None Detected	<u>Percent Non-Fibrous Material:</u> 100

Lab No.: 6368215 Client No.: A-015	Analyst Observation: Grey Insulation Client Description: Pipe Fitting Insulation	Location: Main Floor Facility:
<u>Percent Asbestos:</u> <i>None Detected</i>	<u>Percent Non-Asbestos Fibrous Material:</u> 50 Mineral Wool	<u>Percent Non-Fibrous Material:</u> 50

Lab No.: 6368216 Client No.: A-016	Analyst Observation: Grey Caulk Client Description: Lt Grey Expansion Joint Caulking	Location: Exterior Facility:
<u>Percent Asbestos:</u> <i>None Detected</i>	<u>Percent Non-Asbestos Fibrous Material:</u> None Detected	<u>Percent Non-Fibrous Material:</u> 100

Lab No.: 6368217 Client No.: A-017	Analyst Observation: Brown Caulk Client Description: Brown Window Caulking	Location: Exterior Facility:
<u>Percent Asbestos:</u> <i>None Detected</i>	<u>Percent Non-Asbestos Fibrous Material:</u> None Detected	<u>Percent Non-Fibrous Material:</u> 100

Lab No.: 6368218 Client No.: A-018	Analyst Observation: Black Glazing Client Description: Black Window Glazing	Location: Exterior Facility:
<u>Percent Asbestos:</u> 20 Chrysotile	<u>Percent Non-Asbestos Fibrous Material:</u> None Detected	<u>Percent Non-Fibrous Material:</u> 80

Analytical Method -US EPA 600, R93-116. Please refer to the Appendix of this report for further information regarding your analysis.

Date Received: 10/18/2017
Date Analyzed: 10/27/2017
Signature: 
Analyst: Linda Price

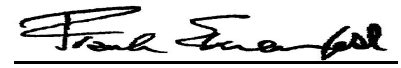
Approved By: 
Frank E. Ehrenfeld, III
Laboratory Director

CERTIFICATE OF ANALYSIS

Client: Golder Associates Ltd 16820 107 Ave Edmonton AB T5P 4C3	Report Date: 10/27/2017 Report No.: 550053 - PLM Project: Digester Bldg Project No.: 1667963	Rev #2, 10/30/2017
Client: GOL572		

PLM BULK SAMPLE ANALYSIS SUMMARY

Lab No.: 6368219 Client No.: A-019	Analyst Observation: Tan Mortar Client Description: Brick Mortar	Location: Exterior Facility:
<u>Percent Asbestos:</u> <i>None Detected</i>	<u>Percent Non-Asbestos Fibrous Material:</u> None Detected	<u>Percent Non-Fibrous Material:</u> 100
Lab No.: 6368220 Client No.: A-020	Analyst Observation: Tan Mortar Client Description: Brick Mortar	Location: Exterior Facility:
<u>Percent Asbestos:</u> <i>None Detected</i>	<u>Percent Non-Asbestos Fibrous Material:</u> None Detected	<u>Percent Non-Fibrous Material:</u> 100
Lab No.: 6368221 Client No.: A-021	Analyst Observation: Tan Mortar Client Description: Brick Mortar	Location: Exterior Facility:
<u>Percent Asbestos:</u> <i>None Detected</i>	<u>Percent Non-Asbestos Fibrous Material:</u> None Detected	<u>Percent Non-Fibrous Material:</u> 100
Lab No.: 6368222 Client No.: A-022	Analyst Observation: Tan Mortar Client Description: Brick Mortar	Location: Exterior Facility:
<u>Percent Asbestos:</u> <i>None Detected</i>	<u>Percent Non-Asbestos Fibrous Material:</u> None Detected	<u>Percent Non-Fibrous Material:</u> 100
Lab No.: 6368223 Client No.: A-023	Analyst Observation: Tan Mortar Client Description: Brick Mortar	Location: Exterior Facility:
<u>Percent Asbestos:</u> <i>None Detected</i>	<u>Percent Non-Asbestos Fibrous Material:</u> None Detected	<u>Percent Non-Fibrous Material:</u> 100

Analytical Method -US EPA 600, R93-116. Please refer to the Appendix of this report for further information regarding your analysis.

Date Received: 10/18/2017
Date Analyzed: 10/27/2017
Signature: 
Analyst: Linda Price

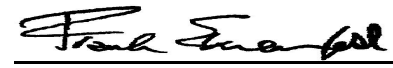
Approved By: 
Frank E. Ehrenfeld, III
Laboratory Director

CERTIFICATE OF ANALYSIS

Client: Golder Associates Ltd
16820 107 Ave
Edmonton AB T5P 4C3

Report Date: 10/27/2017
Report No.: 550053 - PLM
Project: Digester Bldg
Project No.: 1667963

Client: GOL572

Appendix to Analytical Report

Customer Contact:

Analysis: US EPA 600, R93-116

This appendix seeks to promote greater understanding of any observations, exceptions, special instructions, or circumstances that the laboratory needs to communicate to the client concerning the above samples. The information below is used to help promote your ability to make the most informed decisions for you and your customers. Please note the following points of contact for any questions you may have.

iATL Customer Service: customerservice@iatl.com

iATL Office Manager: cdavis@iatl.com

iATL Account Representative: Pete Lesniak

Sample Login Notes: See Batch Sheet Attached

Sample Matrix: Bulk Building Materials

Exceptions Noted: See Following Pages

General Terms, Warrants, Limits, Qualifiers:

General information about iATL capabilities and client/laboratory relationships and responsibilities are spelled out in iATL policies that are listed at www.iATL.com and in our Quality Assurance Manual per ISO 17025 standard requirements. The information therein is a representation of iATL definitions and policies for turnaround times, sample submittal, collection media, blank definitions, quantification issues and limit of detection, analytical methods and procedures, sub-contracting policies, results reporting options, fees, terms, and discounts, confidentiality, sample archival and disposal, and data interpretation.

iATL warrants the test results to be of a precision normal for the type and methodology employed for each sample submitted. iATL disclaims any other warrants, expressed or implied, including warranty of fitness for a particular purpose and warranty of merchantability. iATL accepts no legal responsibility for the purpose for which the client uses test results. Any analytical work performed must be governed by our Standard Terms and Conditions. Prices, methods and detection limits may be changed without notification. Please contact your Customer Service Representative for the most current information.

This confidential report relates only to those item(s) tested and does not represent an endorsement by NIST-NVLAP, AIHA LAP LLC, or any agency of local, state or province governments nor of any agency of the U.S. government.

This report shall not be reproduced except in full, without written approval of the laboratory.

Information Pertinent to this Report:

Analysis by US EPA 600 93-116: Determination of Asbestos in Bulk Building Materials by Polarized Light Microscopy (PLM).

Certifications:

- NIST-NVLAP No. 101165-0
- NY-DOH No. 11021
- AIHA-LAP, LLC No. 100188

Quantification at <0.25% by volume is possible with this method. (PC) Indicates Stratified Point Count Method performed. (PC-Trace) means that asbestos was detected but is not quantifiable under the Point Counting regimen. Analysis includes all distinct separable layers in accordance with EPA 600 Method. If not reported or otherwise noted, layer is either not present or the client has specifically requested that it not be analyzed (ex. analyze until positive instructions). Small asbestos fibers may be missed by PLM due to resolution limitations of the optical microscope. Therefore, PLM is not consistently reliable in detecting asbestos in non-friable organically bound (NOB) materials. Quantitative transmission electron microscopy (TEM) is currently the only method that can pronounce materials as non-asbestos containing.

Analytical Methodology Alternatives: Your initial request for analysis may not have accounted for recent advances in regulatory requirements or advances in technology that are routinely used in similar situations for other qualified projects. You may have the option to explore additional analysis for further information. Below are a few options, listed as the matrix followed by the appropriate methodology. Also included are links to more information on our website.

Bulk Building Materials that are Non-Friable Organically Bound (NOB) by Gravimetric Reduction techniques employing PLM and TEM: ELAP 198.6 (PLM-NOB), ELAP 198.4 (TEM-NOB)

Loose Fill Vermiculite Insulation, Attic Insulation, Zonolite (copyright), etc.: US EPA 600 R-4/004 (multi-tiered analytical process)
Sprayed On Insulation/Fireproofing with Vermiculite (SOF-V): ELAP 198.8 (PLM-SOF-V)>

CERTIFICATE OF ANALYSIS

Client: Golder Associates Ltd
16820 107 Ave
Edmonton AB T5P 4C3

Report Date: 10/27/2017
Report No.: 550053 - PLM
Project: Digester Bldg
Project No.: 1667963

Client: GOL572

Soil, sludge, sediment, aggregate, and like materials analyzed for asbestos or other elongated mineral particles (ex. erionite, etc.): ASTM D7521, CARB 435, and other options available

Asbestos in Surface Dust according to one of ASTM's Methods (very dependent on sampling collection technique – by TEM): ASTM D 5755, D5756, or D6480

Various other asbestos matrices (air, water, etc.) and analytical methods are available.

Disclaimers / Qualifiers:

There may be some samples in this project that have a "NOTE:" associated with a sample result. We use added disclaimers or qualifiers to inform the client about something that requires further explanation. Here is a list with highlighted disclaimers that may be pertinent to this project. For a full explanation of these and other disclaimers, please inquire at customerservice@iatl.com.

- 1) Note: No mastic provided for analysis.
- 2) Note: Insufficient mastic provided for analysis.
- 3) Note: Insufficient material provided for analysis.
- 4) Note: Insufficient sample provided for QC reanalysis.
- 5) Note: Different material than indicated on Sample Log / Description.
- 6) Note: Sample not submitted.
- 7) Note: Attached to asbestos containing material.
- 8) Note: Received wet.
- 9) Note: Possible surface contamination.
- 10) Note: Not building material. 1% threshold may not apply.
- 11) Note: Recommend TEM-NOB analysis as per EPA recommendations.
- 12) Note: Asbestos detected but not quantifiable.
- 13) Note: Multiple identical samples submitted, only one analyzed.
- 14) Note: Analyzed by EPA 600/R-93/116. Point Counting detection limit at 0.080%.
- 15) Note: Analyzed by EPA 600/R-93/116. Point Counting detection limit at 0.125%.

Recommendations for Vermiculite Analysis:

Several analytical protocols exist for the analysis of asbestos in vermiculite. These analytical approaches vary depending upon the nature of the vermiculite mineral being tested (e.g. un-processed gange, homogeneous exfoliated books of mica, or mixed mineral composites). Please contact your client representative for pricing and turnaround time options available.

iATL recommends initial testing using the EPA 600/R-93/116 method. This method is specifically designed for the analysis of asbestos in bulk building materials. It provides an acceptable starting point for primary screening of vermiculite for possible asbestos.

Results from this testing may be inconclusive. EPA suggests proceeding to a multi-tiered analysis involving wet separation techniques in conjunction with PLM and TEM gravimetric analysis (EPA 600/R-04/004).

Further information on this method and other vermiculite and asbestos issues can be found at the following: Agency for Toxic Substances and Disease Registry (ATSDR) www.atsdr.cdc.gov, United States Geological Survey (USGS) www.minerals.usgs.gov/minerals/, US EPA www.epa.gov/asbestos. The USEPA also has an informative brochure "Current Best Practices for Vermiculite Attic Insulation" EPA 747F03001 May 2003, that may assist the health and remediation professional.

The following is a summary of the analytical process outlines in the EPA 600/R-04/004 Method:

- 1) **Analytical Step/Method:** Initial Screening by PLM, EPA 600R-93/116
Requirements/Comments: Minimum of 0.1 g of sample. ~0.25% LOQ for most samples.
- 2) **Analytical Step/Method:** Wet Separation by PLM Gravimetric Technique, EPA R-04/004
Requirements/Comments: Minimum 50g** of dry sample. Analysis of "Sinks" only.
- 3) **Analytical Step/Method:** Wet Separation by PLM Gravimetric Technique, EPA R-04/004
Requirements/Comments: Minimum 50g** of dry sample. Analysis of "Floats" only.
- 4) **Analytical Step/Method:** Wet Separation by TEM Gravimetric Technique, EPA R-04/004
Requirements/Comments: Minimum 50g** of dry sample. Analysis of "Sinks" only.
- 5) **Analytical Step/Method:** Wet Separation by TEM Gravimetric Technique, EPA R-04/004

CERTIFICATE OF ANALYSIS

Client: Golder Associates Ltd
16820 107 Ave
Edmonton AB T5P 4C3

Client: GOL572

Report Date: 10/27/2017
Report No.: 550053 - PLM
Project: Digester Bldg
Project No.: 1667963

Requirements/Comments: Minimum 50g** of dry sample. Analysis of "Suspension" only.

LOQ, Limit of Quantitation estimates for mass and volume analyses.

*With advance notice and confirmation by the laboratory.

**Approximately 1 Liter of sample in double-bagged container (~9x6 inch bag of sample).



APPENDIX B

Site Photographs



APPENDIX B
Site Photographs



Photograph 1: Asbestos-Containing Cast Iron Joint Packing.



Photograph 2: Asbestos-Containing Exterior Black Window Caulking.

\\golder\galledmonton\active\2016\3 proj\1667963 cityofsaskatoon_asbsurveys_saskatoon\07 reports\56 - wastewater digester bldgs and digesters\appendix b - site photographs.docx



APPENDIX C

Waste Water Digester Building and Digesters Room by Room Spreadsheet

Appendix C
Waste Water Digester Building and Digesters
ACM Inventory

Included/Excluded	Floor	Room #	Area Description	Elements	Subelements	Material Description	Accessibility	Suspect?	Sampled?	Asbestos Containing Material?	Condition	Field Notes	Sample Type	Sample ID	Sample Date	Asbestos Type	ACM Product	% of asbestos	Friable	Sprayed-on	Maintenance	Inspection	Priority	Potential for Disturbance	Recommended Action	Quantity	Photograph ID	Labelling Type	
Included	M	Throughout	Throughout	Door	Regular Door	Non Suspect Door	High	No	No	No	Good	Non-suspect door was observed at the Site.																	
Included	M	Throughout	Throughout	Doors	Suspect Fire Doors	Suspect Fire Doors	High	Yes	No	Potential	Good	Not sampled as damage to the door would affect its operational requirement.													Inspect and sample if scheduled for removal.				
Included	B	Basement and Stairwell	Open Area	Walls	Walls	Concrete	High	No	No	No	Good																		
Included	B	Basement and Stairwell	Open Area	Walls	Walls	Cinderblock	High	No	No	No	Good																		
Included	B	Basement and Stairwell	Open Area	Floor	Floor	Skim Coat	High	No	Yes	No	Good	On concrete.	Bulk	A-002, A-005, A-012	12-Oct-17														
Included	B	Basement and Stairwell	Open Area	Floor	Floor	Concrete	High	No	No	No	Good																		
Included	B	Basement and Stairwell	Open Area	Ceiling	Ceiling	Concrete	High	No	No	No	Good																		
Included	B	Basement and Stairwell	Open Area	Mechanical	Piping	Metal Pipes	High	No	No	No	Good	Bare or insulated with fibreglass and PVC fittings.																	
Included	B	Basement and Stairwell	Open Area	Mechanical	Piping	Insulation	High	No	Yes	No	Good	Located on pipe fittings.	Bulk	A-001, A-003, A-004	12-Oct-17														
Included	B	Basement and Stairwell	Open Area	Mechanical	Piping	Packing Material	High	No	Yes	No	Good	In cast iron joints.	Bulk	A-013	12-Oct-17	Amosite	Packing Material	30	Yes	No	N/A	Annually	5	High	Manage in place.	1 joint.	Photograph 1	Doorjamb	
Included	B	Basement and Stairwell	Open Area	Miscellaneous	Firestop	Grey Firestop	High	No	Yes	No	Good		Bulk	A-014	12-Oct-17														
Included	B	Basement and Stairwell	Open Area	Electrical	Electrical Panels and Components	Electrical Panels and Components	High	Yes	No	Potential	Good	Not sampled due to safety concerns.													Inspect and sample if scheduled for removal.				
Included	M	Main Floor	Open Area	Walls	Walls	Concrete	High	No	No	No	Good																		
Included	M	Main Floor	Open Area	Walls	Walls	Cinderblock	High	No	No	No	Good																		
Included	M	Main Floor	Open Area	Floor	Floor	Concrete	High	No	No	No	Good																		
Included	M	Main Floor	Open Area	Ceiling	Ceiling	Concrete	High	No	No	No	Good																		
Included	M	Main Floor	Open Area	Mechanical	Piping	Metal Pipes	High	No	No	No	Good	Bare or insulated with fibreglass and PVC fittings.																	
Included	M	Main Floor	Open Area	Mechanical	Piping	Insulation	High	No	Yes	No	Good	Located on pipe fittings.	Bulk	A-015	12-Oct-17														
Included	S	Second Floor	Open Area	Mechanical	Piping	Packing Material	High	No	No	No	Good	Suspected to be lead.																	
Included	M	Main Floor	Open Area	Windows	Caulking	Brown Caulking	High	No	Yes	No	Good	On window frames.	Bulk	A-006	12-Oct-17														
Included	M	Main Floor	Open Area	Miscellaneous	Firestop	Red Firestop	High	No	Yes	No	Good		Bulk	A-008	12-Oct-17														
Included	M	Main Floor	Open Area	Miscellaneous	Caulking	Grey Caulking	High	No	Yes	No	Good	On expansion joints	Bulk	A-007	12-Oct-17														
Included	M	Main Floor	Open Area	Electrical	Electrical Panels and Components	Electrical Panels and Components	High	Yes	No	Potential	Good	Not sampled due to safety concerns.													Inspect and sample if scheduled for removal.				
Included	S	Second Floor	Open Area	Walls	Walls	Concrete	High	No	No	No	Good																		
Included	S	Second Floor	Open Area	Walls	Walls	Cinderblock	High	No	No	No	Good																		
Included	S	Second Floor	Open Area	Floor	Floor	Concrete	High	No	No	No	Good																		
Included	S	Second Floor	Open Area	Ceiling	Ceiling	Concrete	High	No	No	No	Good																		
Included	S	Second Floor	Open Area	Mechanical	Piping	Metal Pipes	High	No	No	No	Good	Bare or insulated with fibreglass and PVC fittings.																	
Included	S	Second Floor	Open Area	Mechanical	Piping	Insulation	High	No	Yes	No	Good	Located on pipe fittings.	Bulk	A-009	12-Oct-17														
Included	S	Second Floor	Open Area	Mechanical	Piping	Packing Material	High	No	No	No	Good	Suspected to be lead.																	
Included	S	Second Floor	Open Area	Windows	Caulking	Brown Caulking	High	No	Yes	No	Good	On window frames.	Bulk	V.S. A-006	12-Oct-17														
Included	S	Second Floor	Open Area	Miscellaneous	Firestop	Red Firestop	High	No	Yes	No	Good		Bulk	V.S. A-008	12-Oct-17														
Included	S	Second Floor	Open Area	Miscellaneous	Caulking	Grey Caulking	High	No	Yes	No	Good	On expansion joints	Bulk	V.S. A-007	12-Oct-17														
Included	S	MCC	MCC	Walls	Walls	Concrete	High	No	No	No	Good	Suspected to be lead.M29																	
Included	S	MCC	MCC	Walls	Walls	Cinderblock	High	No	No	No	Good																		
Included	S	MCC	MCC	Floor	Floor	Concrete	High	No	No	No	Good																		
Included	S	MCC	MCC	Ceiling	Ceiling	Concrete	High	No	No	No	Good																		
Included	S	MCC	MCC	Mechanical	Duct Work	Grey Duct Mastic	High	No	Yes	No	Good	Uninsulated ducting.	Bulk	A-010	12-Oct-17														
Included	S	MCC	MCC	Miscellaneous	Firestop	Red Firestop	High	No	Yes	No	Good		Bulk	V.S. A-008	12-Oct-17														
Included	S	MCC	MCC	Miscellaneous	Caulking	Black Caulking	High	No	Yes	No	Good	On door frame.	Bulk	A-011	12-Oct-17														
Included	E	Exterior	Exterior	Walls	Walls	Brick	High	No	Yes	No	Good	Brick mortar sampled.	Bulk	A-019, A-020, A-021, A-022, A-023	12-Oct-17														
Included	E	Exterior	Exterior	Windows	Caulking	Brown Caulking	High	No	Yes	No	Good	On window frames.	Bulk	A-017	12-Oct-17														
Included	E	Exterior	Exterior	Windows	Glazing	Black Glazing	High	No	Yes	No	Good	On window panes.	Bulk	A-018	12-Oct-17	Chrysotile	Glazing	20	No	No	N/A	Annually	5	High	Manage in place.	850 ft.	Photograph 2	Doorjamb	
Included	E	Exterior	Exterior	Miscellaneous	Caulking	Light Grey Caulking	High	No	Yes	No	Good	On expansion joints.	Bulk	A-016	12-Oct-17														
Excluded	E	Exterior	Roof	Exterior Roof	Exterior Roof							Not assessed due to scope of work.																	



APPENDIX D

Floor Plans

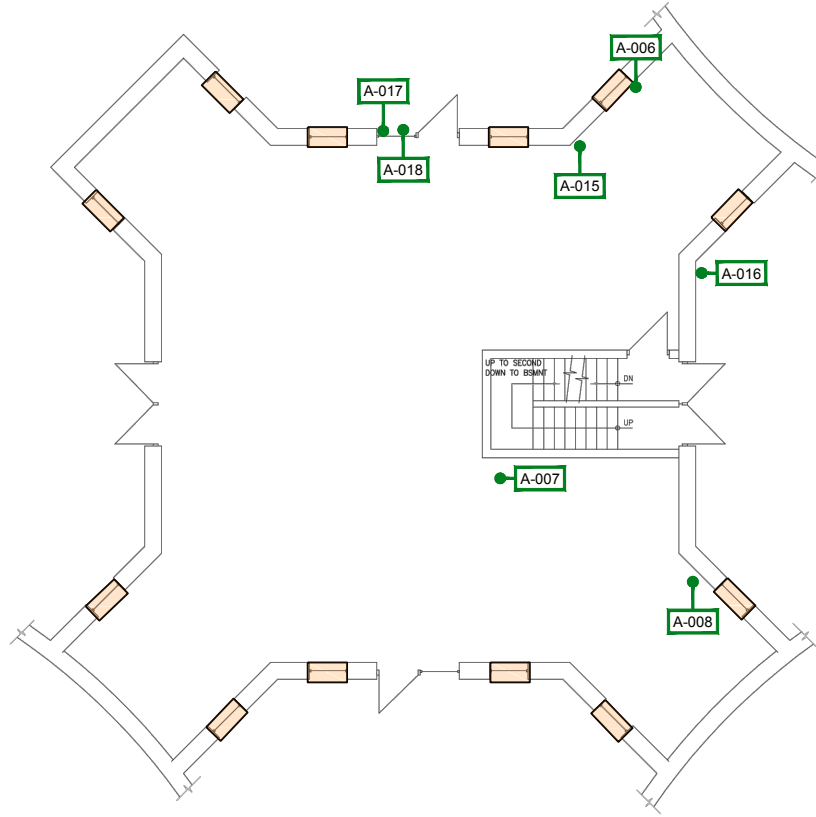

LEGEND

- # ASBESTOS SAMPLE LOCATION
- ASBESTOS-CONTAINING CAST IRON JOINT PACKING
- ASBESTOS-CONTAINING EXTERIOR WINDOW CAULKING

NOTE(S)

1. ASBESTOS IS A CARCINOGEN. DO NOT BREATHE ASBESTOS DUST.

REFERENCE(S)

PLAN OBTAINED FROM INFRASTRUCTURE SERVICES DEPARTMENT CITY OF SASKATOON. DATED: 09/28/2017

CLIENT
 CITY OF SASKATOON

CONSULTANT



YYYY-MM-DD 2017-12-06

DESIGNED KH

PREPARED VI

REVIEWED KH

APPROVED AG

SCHEMATIC ONLY, NOT TO SCALE

PROJECT
 ASBESTOS ASSESSMENT
 WASTE WATER DIGESTER BUILDING AND DIGESTERS
 470 WHITESWAN DRIVE

TITLE
MAIN FLOOR

PROJECT NO.
 1667963

CONTROL
 1000-HM-0007

REV.
 0



FIGURE
 2

IF THIS MEASUREMENT DOES NOT MATCH WHAT IS SHOWN, THE SHEET SIZE HAS BEEN MODIFIED FROM: ANSI A

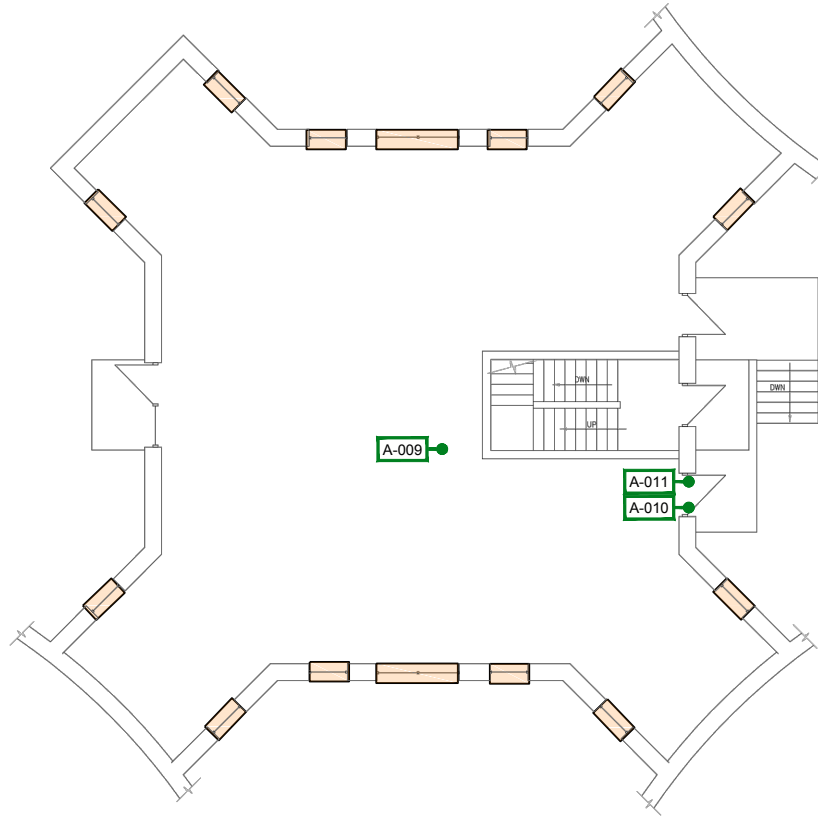
26 mm



LEGEND

-  ASBESTOS SAMPLE LOCATION
-  ASBESTOS-CONTAINING CAST IRON JOINT PACKING
-  ASBESTOS-CONTAINING EXTERIOR WINDOW CAULKING

NOTE(S)

1. ASBESTOS IS A CARCINOGEN. DO NOT BREATHE ASBESTOS DUST.

REFERENCE(S)

PLAN OBTAINED FROM INFRASTRUCTURE SERVICES DEPARTMENT CITY OF SASKATOON. DATED: 14/11/2016

CLIENT
 CITY OF SASKATOON

CONSULTANT



YYYY-MM-DD 2017-12-06

DESIGNED KH

PREPARED VI

REVIEWED KH

APPROVED AG

SCHEMATIC ONLY, NOT TO SCALE

PROJECT
 ASBESTOS ASSESSMENT
 WASTE WATER DIGESTER BUILDING AND DIGESTERS
 470 WHITESWAN DRIVE

TITLE
SECOND FLOOR

PROJECT NO. 1667963 CONTROL 1000-HM-0008

REV. 0

FIGURE 3

IF THIS MEASUREMENT DOES NOT MATCH WHAT IS SHOWN, THE SHEET SIZE HAS BEEN MODIFIED FROM: ANSI A

26 mm

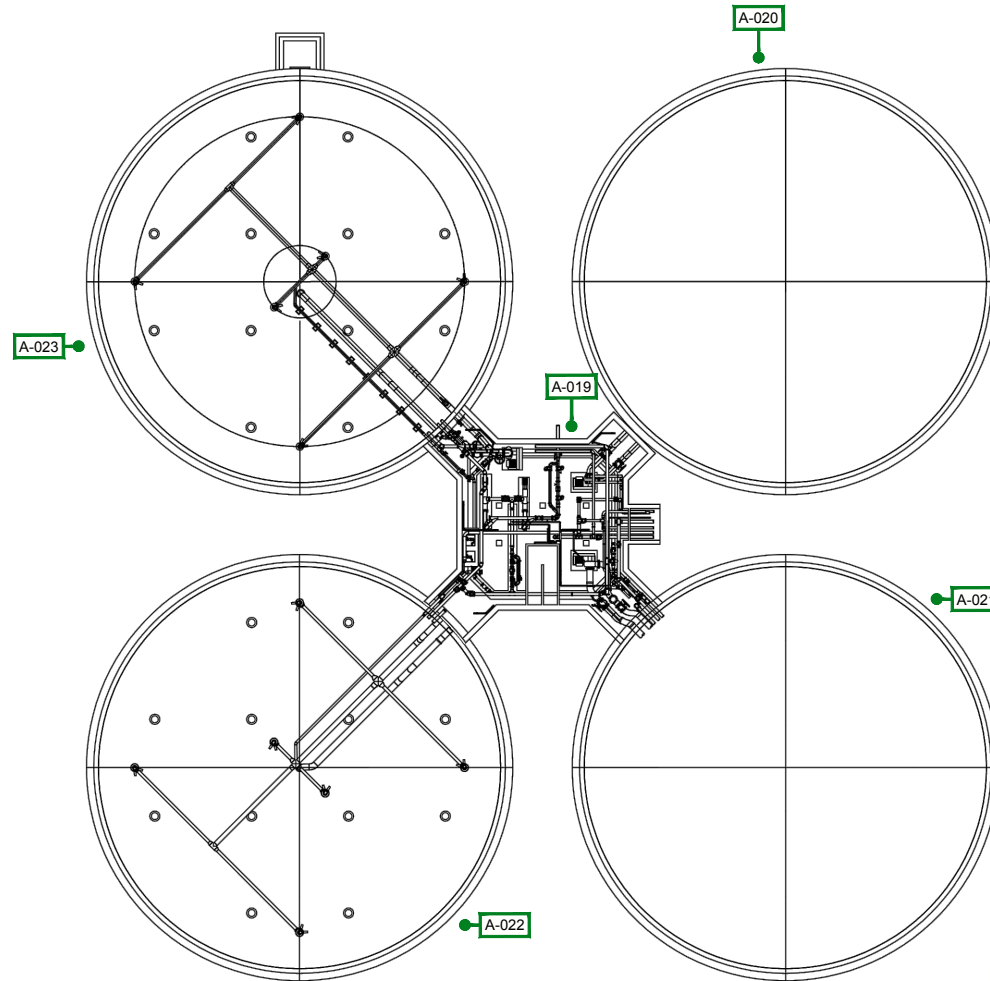

LEGEND

- # ASBESTOS SAMPLE LOCATION
- ASBESTOS-CONTAINING CAST IRON JOINT PACKING
- ASBESTOS-CONTAINING EXTERIOR WINDOW CAULKING

NOTE(S)

1. ASBESTOS IS A CARCINOGEN. DO NOT BREATHE ASBESTOS DUST.

REFERENCE(S)

PLAN OBTAINED FROM INFRASTRUCTURE SERVICES DEPARTMENT CITY OF SASKATOON. DATED: 14/11/2016

CLIENT
CITY OF SASKATOON

CONSULTANT



YYYY-MM-DD 2017-12-07

DESIGNED KH

PREPARED VI

REVIEWED KH

APPROVED AG

SCHEMATIC ONLY, NOT TO SCALE

PROJECT
**ASBESTOS ASSESSMENT
 WASTE WATER DIGESTER BUILDING AND DIGESTERS
 470 WHITESWAN DRIVE**

TITLE
EXTERIOR

PROJECT NO. 1667963	CONTROL 1000-HM-0010	REV. 0	FIGURE 4
-------------------------------	--------------------------------	------------------	--------------------

IF THIS MEASUREMENT DOES NOT MATCH WHAT IS SHOWN, THE SHEET SIZE HAS BEEN MODIFIED FROM: ANSI A

26 mm

As a global, employee-owned organisation with over 50 years of experience, Golder Associates is driven by our purpose to engineer earth's development while preserving earth's integrity. We deliver solutions that help our clients achieve their sustainable development goals by providing a wide range of independent consulting, design and construction services in our specialist areas of earth, environment and energy.

For more information, visit golder.com

Africa	+ 27 11 254 4800
Asia	+ 86 21 6258 5522
Australasia	+ 61 3 8862 3500
Europe	+ 356 21 42 30 20
North America	+ 1 800 275 3281
South America	+ 56 2 2616 2000

solutions@golder.com
www.golder.com

Golder Associates Ltd.
16820 107 Avenue
Edmonton, Alberta, T5P 4C3
Canada
T: +1 (780) 483 3499

