



Saskatoon Light & Power Inventory Catalogue

Revised March 11, 2024

Product Approval and Inclusion Process for Saskatoon Light & Power Catalogue

At the City of Saskatoon – Saskatoon Light & Power, we are always on the lookout for innovative and high-quality products to enhance our catalogue and better serve our customers. If you have a product that you believe aligns with an item in our catalogue, then we encourage you to follow the steps below for product approval:

1. Product Submission:

- a. Please prepare a comprehensive product proposal that includes detailed information about your product such as features, specifications, and any relevant certifications.
- b. Attach high-quality images or product renders that showcase the product from different angles.

2. Compliance and Certification:

- a. Ensure that your product complies with industry standards and regulations.
- b. If applicable, include any certifications or test reports that demonstrate the product's safety and quality.

3. Contact Information:

- a. Include your complete contact information including the name, email address, and phone number of a dedicated representative we can reach out to for further discussion.

4. Samples for Evaluation:

- a. If possible, offer product samples for our team to evaluate the quality, functionality, and overall appeal of your product.

Please submit the above information to saskatoon.light.power@saskatoon.ca with the subject line 'Inventory Catalogue Submission for Review', and our team will carefully review your proposal. We appreciate your interest in partnering with Saskatoon Light & Power and look forward to the possibility of adding your products to our catalogue.

TABLE OF CONTENTS

Index.....	iii
Supplier's Codes	vii
Section 1 Pole Line Hardware	1 – 1
Anchors	
Bolts	
Braces And Brackets	
Washers	
Guy Wire	
Section 2 Wire / Cable / Cutouts, etc.	2 – 1
Clamps & Grips	
Lubricant	
Cutouts and Arrestors	
Insulators	
Wire & Cable	
Section 3 Distribution Poles	3 – 1
Wood Poles	
Steel Poles	
Fibreglass Poles	
Section 4 Street Lighting	4 – 1
Refractors	
Ballasts	
Fixtures & Lamps	
Streetlight Poles & Arms	
Photo Electric Cells	
Section 5 Connectors	5 – 1
Connectors	
Compression Sleeves	
Bolted Lugs	
Section 6 Transformers.....	6 – 1
Padmount Transformers	
Switching Cubicles	
Concrete Bases	
Elbows & Accessories	
Overhead Transformers	

TABLE OF CONTENTS

Section 7	Fusing & Splicing.....	7 – 1
	Transformer Bushings	
	Fuses	
	Tape	
	Markers	
	Solder	
	Kellems Grips	
	Stress Cone Kits	
	Underground – Splice Parts	
	Heat Shrink	
Section 8	Switchgear & Metering.....	8 – 1
	Relay	
	Meter Seals	
	Current Transformers	
	Test Blocks	
Section 9	Ducts, Grounding, Cable Injection & Miscellaneous.....	9 – 1
	Pipe Straps	
	Duct Pipe	
	Anchors	
	Capacitors	
	Locks	
	Bandit	
	Grounding	
	Ty-Wraps	
	Gloves & Mitts	
Section 10	Clothing.....	10 – 1
	FR Pullover Top	
	FR Button Up Top	
	FR Work Pants	
	FR Cargo Pants	
	FR Coveralls (Lined and Unlined)	
	FR Bid Overalls (Lined and Unlined)	
	FR Hooded Fleece	
	FR Winter Jacket	
	FR Rain Overalls	
	FR Rain Jackets	
	FR Balaclava/ Neck Gaiter/ Toque	
	FR Hard Hat Liner	

TABLE OF CONTENTS

Section 11	Landfill Gas Generation	11 – 1
	Service Items	
	Ignition System	
	Coolant System	
	Turbo Exhaust	
	Fuel Train	
	General Engine	
	Engine Controls	
	Starter	

INDEX

ADAPTERS

Base Plate for Steel Pole	4-13
Interbase Low Profile.....	8-12
Socket.....	8-12
Steel Pole Tenon	4-13

AGS UNIT	2-5
-----------------------	-----

AMFACTS	5-6-7
----------------------	-------

ANCHORS

Pole Key.....	1-2
Drop In.....	9-8
Helix.....	1-1
Rod.....	1-1

ARMS (see Street Lighting)

ARMOUR RODS	2-24
--------------------------	------

ARRESTORS	2-13
------------------------	------

AQUASEAL	7-22
-----------------------	------

BALLASTS	4-31
-----------------------	------

BANDIT & BUCKLES	9-12
-----------------------------------	------

BANNER HARDWARE	4-32
------------------------------	------

BASES

Break Away Reaction Plates.....	4-14
Concrete	6-10-12
Decorative	4-1,9
Fiberglass	6-10,21
Mounting for Epoxy Crossarm	1-8
Precast Streetlight	4-1
Precast Switching Cubicle	6-11
Precast Transformer	6-10
Steel Anchor.....	4-1

BAYONET	1-8
----------------------	-----

BOLLARDS	1-2
-----------------------	-----

BOLTS

Carriage.....	1-3-4
Double Arming	1-3
Lag	1-6
Machine.....	1-4-6

BRACES

Alley Arm	1-7
Angle Arm	1-7
Cross Arm.....	1-8

BRACKETS

Bullhorn	4-12
Cable Support.....	7-25
Decorative Backing.....	4-11

BRACKETS – continued

Kellems Grip Mounting.....	7-25
Mid-Span Triplex.....	1-9
Network	1-22-23
Standoff	1-9
Transformer Mounting.....	1-9

BRAID	7-20
--------------------	------

BULL LINE	2-7
------------------------	-----

BUMPER POST	1-2
--------------------------	-----

BUSHING WELL	6-23
---------------------------	------

BUSHING WELL INSERTS	6-18
-----------------------------------	------

BUSHINGS

Adapter	6-19
One Piece.....	6-23
Standoff	6-21
Transformer	7-2

CABINETS	6-21
-----------------------	------

CABLE	2-26-37
--------------------	---------

CABLE SUPPORTS

Kellems.....	7-26
--------------	------

CADWELD CARTRIDGES	7-23
---------------------------------	------

CAPACITOR BANKS	9-10
------------------------------	------

CAPACITOR UNITS	9-9
------------------------------	-----

CAPS

Protective.....	6-22
Photo Cell Shorting.....	4-27-28

CINCH TIES & TY-WRAPS	9-15-16
--	---------

CLAMPS

Bonding Jumper.....	5-6
Cable Cleats	2-20-21
Ground Rod	2-5
Guy	1-14
Hot Line.....	2-7
Deadend Strain.....	2-3
Service Wedge.....	2-2
Suspension	2-5

CLEVISES	1-10
-----------------------	------

COLD SHRINK

Splice	7-31-32
--------------	---------

COMPOUNDS

Splicing.....	2-7
---------------	-----

CONNECTORS

Ampact.....	5-6-7
Bolted.....	5-20

INDEX

CONNECTORS - continued

Buchanan.....	5-15
Compression	5-18-20
GelCap	5-14
Parallel, Groove, Compression	5-1-4
Shearbolt	5-17-18
Sleeves	5-8-15
Split Bolt	5-4-5
Station	5-21-22
Stirrup	5-7-8
Two Bolt	5-5
Type "T"	5-20

CONTACTORS	4-29
Coils	4-29

COUPLINGS

Ground Rod.....	2-6
-----------------	-----

COVERS

Meter Blankoff.....	8-11
---------------------	------

CROSSARMS	1-10-11
------------------------	---------

CURRENT TRANSFORMERS	8-12-14
-----------------------------------	---------

CUTOUTS	2-9-10,13
----------------------	-----------

DAMPERS	2-26
----------------------	------

DEADENDS

Automatic.....	2-2
Compression	2-1-2

DUCT

Bellend	9-5
Bends.....	9-3-4
Couplings	9-5-6
Pipe	9-2-3,7
Spacers	9-6

DUPLEX	2-29
---------------------	------

DUXSEAL	7-22
----------------------	------

ELBOWS & ACCESSORIES	6-15-23
---------------------------------------	---------

EXTENSIONS

Steel Streetlight Pole.....	4-14
-----------------------------	------

FAULT INDICATORS	6-13-15
-------------------------------	---------

FEED-THROUGHS	6-19-20
----------------------------	---------

FIBRE OPTIC CABLE	2-36-37
--------------------------------	---------

FITTINGS

Ball Clevis	1-13
Clevis – Clevis.....	2-1
Guy	1-14-16
Socket Eye	1-12
Clevis Socket	1-12
Y Clevis	1-13

FIXTURES	4-16-24
-----------------------	---------

FR CLOTHING

FR Balaclava.....	10-10
FR Cargo Pants Men's.....	10-3-4
FR Cargo Pants Women's	10-4-5
FR Hard Hat Liner	10-10
FR Hooded Fleece	10-8
FR Lined Bib Overalls.....	10-8
FR Neck Gaiter	10-10
FR Rain Jackets	10-10
FR Rain Overalls	10-9-10
FR Shirts Buttoned Men's	10-2
FR Shirts Buttoned Women's	10-2
FR Shirts Pullover Men's	10-1
FR Shirts Pullover Women's	10-1
FR Unlined Bib Overalls	10-7
FR Unlined Coveralls	10-6-7
FR Winter Jacket	10-9
FR Work Pants Men's	10-3
FR Work Pants Women's	10-3-4

FUSES

Elbow.....	7-14
Ferrule.....	7-15
Knife Blade	7-16
Limiting	7-17-18
Network	7-18-19
Neutral Link.....	7-15
Padmount	7-6-11
Plug.....	7-14
Power	7-12-13
PT.....	7-16
Switching Cubicle.....	7-13
Type K.....	7-2-3
Type T.....	7-4
Types H, X, F.....	7-5

GEL CAPS	5-14
-----------------------	------

INDEX

GLOBES

Washington Fixtures 4-32

GLOVES 9-17-18

GRIPS

Preformed Deadend..... 2-3-4

Preformed Guy..... 1-14

GROUND ROD 2-6

GROUNDING MATERIAL 9-13-14

GUARDS..... 1-16

HANDI-RING 8-11

HEAT SHRINK

Splice..... 7-30

HEATER CABINET 9-12

HOOKS

Cable Hangers 7-26

Hooks & Arms for U/G Cable Rack 1-17-18

INSULATORS

Ball and Socket 2-16

Cable Rack 2-21

Clevis 2-15

Epoxy Deadend..... 2-17

Fiberglass Guy Strain..... 1-27

Guy Strain 2-15

Indoor Switching Cubicle 2-22

Phase Conduction Spacing..... 2-17

Pin Type..... 2-14

Polymer..... 2-17-18

Post..... 2-18-20

Station Post 2-19-19

Suspension 2-16

Triplex Spreader Block 2-22

JUNCTION BOX..... 6-13

LAMPS 4-25-26

LANDFILL GAS GENERATION

Coolant System 11-6-10

Engine Controls..... 11-15-16

Fuel Train..... 11-12-14

General Engine..... 11-14-15

General Sensors..... 11-3

LANDFILL GAS GENERATION continued

Ignition System..... 11-4-6

Oil System 11-4

Service Items 11-1-3

Turbo Exhaust..... 11-11-12

LOCKS 9-11

LUBRICANTS

Cable Pulling 2-8

Switch Contact..... 2-8

Termi Kit 2-8

LUGS

Bolted..... 5-16-17

Compression 5-18-20

MAN HOLE 7-23

MARKERS

Cable Tags 7-21

Omni Balls Red..... 7-21

Phase..... 7-21

MITTS 9-18

MOULDING

Ground Wire 2-22

NUTS

Galvanized 1-24, 26

Eye 1-19

Lock 1-20

Pisa..... 1-1

Thimble Eye..... 1-19

OIL SWITCHES..... 2-23 & 4-29

PADLOCKS 9-11

PEDESTALS 6-12-13

PHOTO ELECTRIC CELLS 4-27-28

Bracket..... 4-28

Shorting Cap 4-27-28

PINS

Insulator 1-20-21

PIPE

Bends 9-3-4

Cement/Primer..... 9-7

Duct 9-2-3

INDEX

PIPE - continued

Galvanized	9-2
HDPE	9-2-3
Sceptacon	9-7
Spacers	9-6
Straps.....	9-1

PLASTIC LATCH..... 7-6

POLES (DISTRIBUTION)

Steel.....	3-1-2
Fiberglass.....	3-2
Wood.....	3-1

POTENTIAL TRANSFORMERS..... 8-15

PREFORMED

Armour Rod	2-24
Composite	2-25
Plastic Line.....	2-24
Super Top Ties.....	2-25

PRIMARY METERING UNIT 8-17 |

PYROTENAX CLIPS 9-1 |

QUADRIplex..... 2-29

RACKS 1-21-22 |

REFRACTORS

Wallpack Fixtures	4-32
-------------------------	------

RELAY FEEDER 8-1 |

RISERS

Fibreglass	1-17
Plastic.....	1-17

SEALS

Meter	8-10
Padlock.....	8-11

SLEEVES

Compression	5-8-15
Guy Wire Serving	1-14

SOCKETS

Pig Tail.....	4-27
---------------	------

SPLICE KITS

Grounding Sock	7-32
Underground	7-28

STAPLES

Moulding.....	1-24
---------------	------

STREET LIGHTING

Arms	4-3-6,8-12
Hand Hole Assembly.....	4-15
Poles.....	4-2-10
Pole & Fixture Combination.....	4-22
Relays	4-28
Shims	1-27
Weatherheads.....	4-30

STRESS CONE KITS 7-24-25 |

SWITCHES

Oil	2-23 & 4-29
Three Phase Group Operated.....	2-11-12

SWITCHING CUBICLES..... 6-8-9

TAPE..... 7-20 |

TEST BLOCKS 8-16-17 |

THIMBLE

Eye	1-19
-----------	------

TRANSFORMERS

Cluster Mount Assembly	1-9
Dry Type.....	8-16
Overhead.....	6-23-28
Padmount.....	6-1-8

TRIPLEX 2-29 |

TY-WRAPs & CINCH TIES 9-15-16 |



WASHERS 1-24-26 |

WIRE



Guy	1-27
Metering.....	2-35
Streetlight.....	2-33

SUPPLIER CODES



AB	AB Chance	EK.....	Ekstrom
ABB.....	ABB Inc.	EE	English Electric
AC	Acculite	ELMD.....	Elasimold
ACME	Acme	ENE	Enerscan
AE.....	American Electric	EPAC.....	EPAC
AL.....	Aim Lite		
ALUM	Alumaform		
AMP	Ampact	FAN	Fanner
ANSI.....	ANSI	FAR	Fargo
AP	Atlas Power	FED-P	Federal Pioneer
		FER.....	Ferraz
		FER-P	Ferranti-Packard
		FP.....	Fisher Pierce
B&T	Bearing & Transmission		
BAND.....	Band-It		
BEL	Beline Manufacturing		
BEM	Bemag	GE.....	General Electric
BET	Bethea	GLD.....	Gould
BEV	Bevro	GLP	GLP HiTech
BLK	Blackburn	GRNL	Greenlee
BM.....	Bren Maur	GST&D.....	General Switchgear GST&D
BRO.....	Brooks		
BUCH.....	Buchanan		
BUR.....	Burndy	HA	Hastings
BUSS	Buss	HCI.....	HCI Lighting
		HEL	Helix
		HOL.....	Holophane
		HOM.....	Homac
		HU	Hughes Bros
		HUB.....	Hubbel
		HYD	Hydel
CAD.....	Cadweld		
CAN.....	Canron	IBV	Iberville
CAB.....	Cablelim	IDI	Ideal Electric Industries
CAR.....	Carlton	ILS.....	ILSCO
CC.....	Cross Canada	INT	Intermatic
CG	Condu-Grip	INV	Inventronics
CGE	Canadian General Electric	IPEX.....	IPEX
CH	Cutler Hammer		
CIM	CIM		
CLM	CLM Industries		
CON.....	Continental(Maclean Power)		
COND.....	Condux International		
CP	Cooper Power		
		JOS	Joslyn
		JSNA	JS Hardware North America
DG	DG Technologies Ltd.		
DIV	Diversified		
DIX.....	Dixie		
DL.....	Dura-Line	KAB.....	Kabar
DULM	Dulmison	KEE	Keene
		KELL.....	Kellems
		KL.....	K-Line
		KRN.....	Kearney
EWC	Eastern Wire & Conduit		

DESCRIPTION OF ITEM	DEPT. CODE NUMBER	SIZE	ORDERING INFORMATION
<p>Multi Helix Anchor</p> 	<p>1-01-48 5001198</p>	<p>Blade 8 Inch</p>	<p>AB E102-1636 JOS J25997CAB1 DIX D-84-2-6</p>
<p>Anchor Rod</p> 	<p>1-01-53 5001199</p>	<p>1" x 7'</p>	<p>AB 12334P KAB K156-23 JOS J12255R DIX D-101</p>
<p>Triple Eye Pisa Nut for Power Anchor</p> 	<p>1-01-63 5001200</p>	<p>1 Inch</p>	<p>AB 12585 JOS J12585 KAB K156-36 DIX D-6567</p>



DESCRIPTION OF ITEM	DEPT. CODE NUMBER	SIZE	ORDERING INFORMATION
<p>Pole Key Anchor use 2 per pole (BOOK OUT SEPARATELY)</p> 	<p>1-01-72 5000000</p>	<p>7" x 27 1/4"</p>	<p>AB P4817</p>
<p>Bumper Post</p> 	<p>1-02-01 5000001</p>	<p>8" Helix, 3 1/2" OD 75" Shaft</p>	<p>AB T1120224</p>
<p>Bollard Plastic Sleeve</p>  <p>Bollard Pipe</p> 	<p>1-03-01 5000002</p> <p>1-03-03 5000003</p>	<p>4" x 52"</p> <p>SCH40 4" x 84"</p>	<p>U-LINE H-6425</p> <p>Russel Metals - pipe is cut from a 252" length 3 pieces at 84"</p>



DESCRIPTION OF ITEM	DEPT. CODE NUMBER	SIZE	ORDERING INFORMATION
Carriage Bolt 	1-08-45 5001201	3/8" x 4 1/2"	HUB 8634 1/2 JOS J8634 1/2
Double Arming Bolt 	1-09-18 5001202 1-09-20 5001203 1-09-22 5001204	5/8" x 18" 5/8" x 20" 5/8" x 22"	SL 9868 HUB 8868 JOS J8868 SL 9870 HUB 8870 JOS J8870 SL 9872 HUB 8872 JOS J8872
Double Arming Bolt 	1-09-24 5001205 1-09-26 5001206	5/8" x 24" 5/8" x 26"	SL 9874 HUB 8874 JOS J8874 SL 9876 HUB 8876 JOS J8876

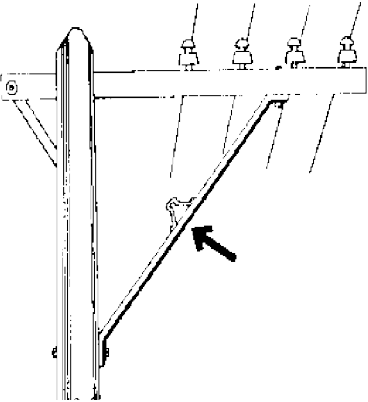

DESCRIPTION OF ITEM	DEPT. CODE NUMBER	SIZE	ORDERING INFORMATION
<p>Carriage Bolt for Steel Anchors</p> 	<p>1-10-04 500004</p>	<p>1" x 4"</p>	<p>GB5HDG1.4</p>
<p>Machine Bolt</p> 	<p>1-12-05 5001207</p> <p>1-12-06 5001208</p> <p>1-12-07 5001209</p>	<p>1/2" x 5"</p> <p>1/2" x 6"</p> <p>1/2" x 7"</p>	<p>HUB 8705 JOS J8705</p> <p>HUB 8706 JOS J8706</p> <p>HUB 8707 JOS J8707</p>
<p>Machine Bolt</p> 	<p>1-12-08 5001210</p> <p>1-12-10 5001211</p> <p>1-12-12 5001212</p>	<p>1/2" x 8"</p> <p>1/2" x 10"</p> <p>1/2" x 12"</p>	<p>HUB 8708 JOS J8708</p> <p>HUB 8710 JOS J8710</p> <p>HUB 8712 JOS J8712</p>

DESCRIPTION OF ITEM	DEPT. CODE NUMBER	SIZE	ORDERING INFORMATION
Machine Bolt 	1-13-06 5001213 1-13-08 5001214 1-13-10 5001215 1-13-12 5001216	5/8" x 6" 5/8" x 8" 5/8" x 10" 5/8" x 12"	HUB 8806 JOS J8806 HUB 8808 JOS J8808 HUB 8810 JOS J8810 HUB 8812 JOS J8812 T&B BM512
Machine Bolt 	1-13-14 5001217 1-13-16 5001218 1-13-18 5001219 1-13-20 5001220	5/8" x 14" 5/8" x 16" 5/8" x 18" 5/8" x 20"	HUB 8814 JOS J8814 T&B BM514 HUB 8816 JOS J8816 HUB 8818 JOS J8818 HUB 8820 JOS J8820
Machine Bolt 	1-13-22 5001221 1-13-24 5001222	5/8" x 22" 5/8" x 24"	HUB 8822 JOS J8822 HUB 8824 JOS J8824

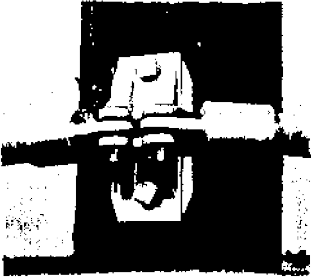
DESCRIPTION OF ITEM	DEPT. CODE NUMBER	SIZE	ORDERING INFORMATION
<p>Machine Bolt</p> 	<p>1-14-08 5001223</p> <p>1-14-10 5001224</p> <p>1-14-12 5001225</p> <p>1-14-14 5001226</p>	<p>3/4" x 8"</p> <p>3/4" x 10"</p> <p>3/4" x 12"</p> <p>3/4" x 14"</p>	<p>HUB 8908 SL 9908 JOS J8908</p> <p>HUB 8910 SL 9910 JOS J8910</p> <p>HUB 8912 SL 9912 JOS J8912</p> <p>HUB 8914 SL 9914 JOS J8914</p>
<p>Machine Bolt</p> 	<p>1-14-16 5001227</p>	<p>3/4" x 16"</p>	<p>HUB 8916 SL 9916 JOS J8916</p>
<p>Lag Bolt</p> 	<p>1-14-82 5000005</p> <p>1-14-86 5000006</p>	<p>3/8" x 2"</p> <p>1/2" x 4"</p>	<p>HYD 238LG</p> <p>HYD 412LG</p>

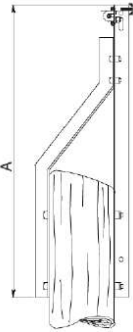

DESCRIPTION OF ITEM	DEPT. CODE NUMBER	SIZE	ORDERING INFORMATION
Grounding Clip #4 For Composite Crossarms	1-15-04 5000007	8 per crossarm, use with #8 x 1" self tapping screws	CLIP236
Alley Arm Brace 	1-17-60 5001228 1-17-84 5000008	60" 84"	HUB 6979 KAB K14-1 HUB 6984
Angle Arm Brace 	1-18-60 5001229 1-18-72 5001230	60" 72"	SL 7953 HUB 6953 JOS J1510 HYD 3460AVB SL 7955 HUB 6955 JOS J1512

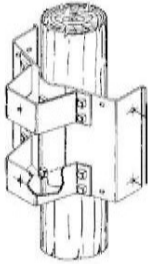

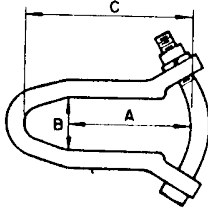
DESCRIPTION OF ITEM	DEPT. CODE NUMBER	SIZE	ORDERING INFORMATION
<p>Mounting Base for 138 KV Epoxy Crossarm (Part of Crossarm 1-30-02)</p> 	<p>1-18-80 500009</p>		<p>See 1-30-02</p>
<p>Crossarm Brace</p> 	<p>1-19-24 500010</p> <p>1-19-30 5001231</p> <p>1-19-32 5001232</p>	<p>24 "</p> <p>30"</p> <p>32"</p>	<p>SL 8024</p> <p>SL 8030 HUB 7130</p> <p>SL 8032 HUB 7132</p>
<p>Bayonet, Steel (Corner)</p> 	<p>1-20-04 5000011</p>	<p>84"</p>	<p>HU AS2613-F4</p>

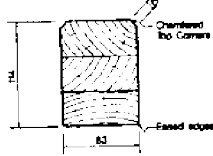
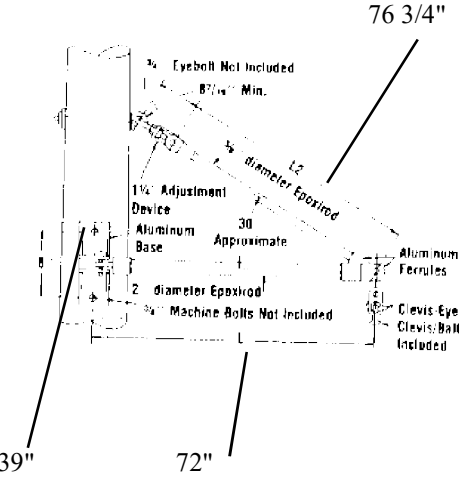
DESCRIPTION OF ITEM	DEPT. CODE NUMBER	SIZE	ORDERING INFORMATION
<p>Standoff Bracket with 13/16" Diameter Centre Hole for 3/4" Steel Pin</p> 	<p>1-21-04 5001489</p>	<p>25 KV</p>	<p>PTS PA619H HUB 1SBM18CL MAC P G1MDA118AT</p>
<p>Mid-Span Triplex Bracket</p> 	<p>1-21-06 5000012</p>		<p>Enerscan 2611 NO SUBS</p>
<p>Transformer Cluster Mount Assembly</p> 	<p>1-21-44 5000013</p>	<p>For 3-Single Phase Trf. from 25 KVA to 75 KVA</p>	<p>JOS J6980</p>

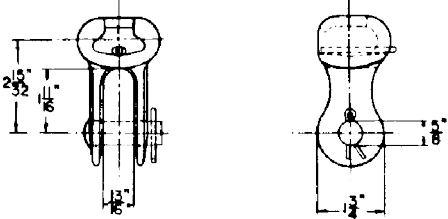

DESCRIPTION OF ITEM	DEPT. CODE NUMBER	SIZE	ORDERING INFORMATION
<p>Clevis - Spool Insulator Type (2-18-13 Insulator)</p> 	<p>1-25-09 5001233</p> <p>1-25-10 5001234</p>	<p>1/2" Pin 3/4" Clevis Bolt Small Secondary</p> <p>5/8" Pin 3/4" Clevis Bolt Large Secondary</p>	<p>HUB 0341 SL 1341 JOS J0313</p> <p>SL 1340 HYD 517CL JOS J0342</p>
<p>Clevis - Strain Insulator Type 5KV Primary</p> 	<p>1-25-14 5001235</p>	<p>5" x 2 1/2" 1/2" Clevis Bolt</p>	<p>SL 832 JOS J732 HUB 732</p>
<p>Crossarm Composite 8 Foot Tangent C/W Bracket</p> <p>Crossarm Composite 8 Foot Deadend C/W Bracket</p> <p>Crossarm Composite 8 Foot Accessory Arm C/W Bracket</p> <p>Crossarm Composite 8 Foot Alley Arm C/W Bracket and Brace</p>	<p>1-28-08 5000014</p> <p>1-28-18 5000015</p> <p>1-28-28 5000016</p> <p>1-28-38 5024547</p>	<p>3 1/2" x 4 1/2" x 8' 3 Pin</p>	<p>Alumaform: FTA18-96-A-IP-HXF Pupi: TB22000966742</p> <p>Alumaform: FDA25-396-EB-IP-FG-HYW: Pupi:DA300096E35562</p> <p>Alumaform: FTA20-396-A-IP-HES Pupi: TB22000961522</p> <p>Pupi: D100345</p>

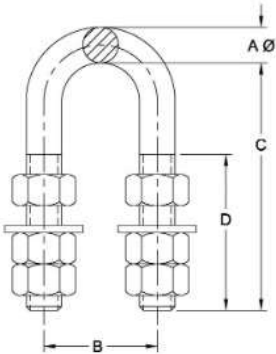

DESCRIPTION OF ITEM	DEPT. CODE NUMBER	SIZE	ORDERING INFORMATION
<p>Fir Crossarm Penta Treated</p>  	<p>1-29-06 5000017</p> <p>1-29-12 5000018</p>	<p>3 1/2" x 4 1/2" x 8' 3 Pin</p> <p>3 3/4" x 4 3/4" x 10' 3 Pin</p>	<p>Dwg. MS-149A</p> <p>Dwg. ST-OH-047</p>
<p>Epoxy Crossarm 138 KV (Includes Mounting Base 1-18-80)</p> 	<p>1-30-02 5000019</p>	<p>72"</p>	<p>PTS 7588-72TB</p>
<p>Crossarm Composite 10 Foot Tangent C/W Bracket</p> <p>Crossarm Composite 10 Foot Deadend C/W Bracket</p> <p>Crossarm Composite 10 Foot Accessary Arm C/W Bracket</p> <p>Crossarm Composite 10 Foot Alley Arm C/W Bracket and Brace</p>	<p>1-31-08 5024810</p> <p>1-31-18 5024811</p> <p>1-31-28 5024812</p> <p>1-31-38 5024813</p>	<p>3 1/2" x 4 1/2" x 10" 3 Pin</p>	<p>Pupi TB20001205222</p> <p>Pupi DA3000120E34352</p> <p>Pupi TB200001205232</p> <p>PUPI D100346</p>



DESCRIPTION OF ITEM	DEPT. CODE NUMBER	SIZE	ORDERING INFORMATION
<p>Suspension Insulator Fitting Clevis Socket</p> 	<p>1-32-11 5001236</p>		<p>SL 60157-C HUB 87603-2000 PLP SC-5194</p>
<p>Suspension Insulator Fitting Ball Eye</p> 	<p>1-32-13 5024808</p>		<p>HUB BE30CVN</p>
<p>Suspension Insulator Fitting Socket Eye</p> 	<p>1-32-20 5000020</p>	<p>to use with 2-02-45</p>	<p>PLP SE5152</p>

DESCRIPTION OF ITEM	DEPT. CODE NUMBER	SIZE	ORDERING INFORMATION
<p>Suspension Insulator Fitting Ball Clevis</p> 	<p>1-32-30 5000021</p> <p>1-32-31 5001237</p>		<p>SL 60151-C</p> <p>BET CB55L HUB 70488-2000</p>
<p>Y-Clevis Eye Standard</p>  <p>90 Degree</p> 	<p>1-32-40 5001238</p> <p>1-32-41 5024974</p>	<p>for use with 2-02-45</p>	<p>HUB YCS05 MAC P YCE-65-625A PLP YCE-30</p> <p>HUB YCS0590 MAC P RYCE-65-625A PLP YC-5207</p>
<p>Tower U-Bolt</p> 	<p>1-32-50 5024809</p> <p>1-32-51 5024976</p>	<p>3" Spacing</p> <p>3 1/2" Spacing</p>	<p>SL 29788</p> <p>SL 83622</p>

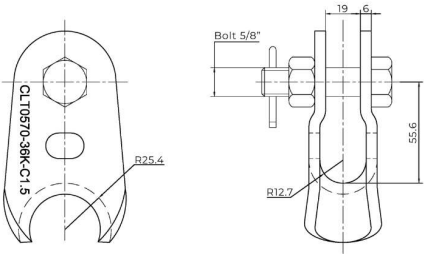

DESCRIPTION OF ITEM	DEPT. CODE NUMBER	SIZE	ORDERING INFORMATION
<p>Preformed Guy Grip Dead-End</p> 	<p>1-33-00 5001239</p> <p>1-33-03 5001240</p> <p>1-33-07 5001241</p> <p>1-33-11 5001242</p>	<p>5/16"</p> <p>3/8"</p> <p>7/16"</p> <p>1/4"</p>	<p>SL 14066 FAN 5/16 GSBG PLP GDE-2106 HEL 40301-L</p> <p>SL 14055 FAN 3/8 GSBG PLP GDE-2107</p> <p>SL 14056 FAN 7/16 GSBG PLP GDE-2108</p> <p>SL 14052 FAN 1/4 GSBG PLP GDE-2104 HEL 40201-5L</p>
<p>Clamp - 3 Bolt Curved Jaws</p>  <p>Guy Clamp - 3 Bolt</p>  <p>Guy Clamp - Offset</p> 	<p>1-33-13 5001243</p> <p>1-33-14 5001244</p> <p>1-33-15 5001245</p> <p>1-33-16 5001246</p>	<p>For Poly Covered Messenger</p> <p>5/8" Bolts</p> <p>1/4" to 3/8" Strand</p> <p>5/16" to 1/2" Strand</p>	<p>ALLIED BOLT 4080 MAC P PA422</p> <p>HYD 358.GU JOS J931 LAC 744 SL 7461 HUB 6461</p> <p>JOS J926 HUB 6409</p> <p>JOS J927 HUB 6410</p>
<p>Guy Wire Serving Sleeve</p> 	<p>1-33-17 5001247</p> <p>1-33-18 5001248</p> <p>1-33-19 5001249</p> <p>1-33-20 5001250</p>	<p>1/4" Strand</p> <p>5/16" Strand</p> <p>3/8" Strand</p> <p>7/16" Strand</p>	<p>SL 7452 HUB 6452</p> <p>SL 7453 HUB 6453</p> <p>SL 7454 KAB K49-2 HUB 6454</p> <p>SL 7458 HUB 6455</p>

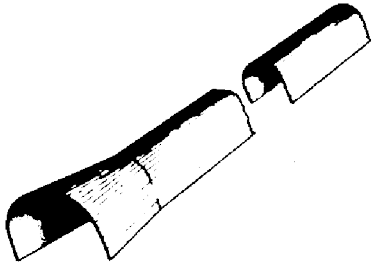

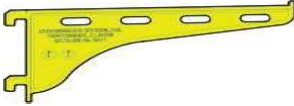
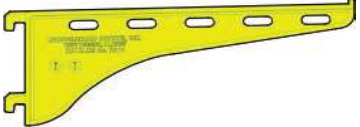
DESCRIPTION OF ITEM	DEPT. CODE NUMBER	SIZE	ORDERING INFORMATION
Guy Wire Splice	1-33-50 5000022	5/16" Strand	T&B ATSG516
Guy Strut Pole Fitting 	1-33-90 5001251		SL 2056 CP DG9D1 KAB K43-4
Guy Strut Guy Fitting 	1-33-92 5001252		SL 2057 HUB 0512 KAB K43-3



DESCRIPTION OF ITEM	DEPT. CODE NUMBER	SIZE	ORDERING INFORMATION
<p>Guy Fitting</p> 	<p>1-33-94 5001253</p>		<p>SL 7587 HYD 34GH</p>
<p>Clevis Thimble Use with preform on Composite Deadend Crossarm</p> 	<p>1-33-96 5025474</p>		<p>JSNA CLT0570-36K- C1.5 SL 24237-E (80468)</p>
<p>Guy Guard PVC Plastic - Yellow</p> 	<p>1-34-02 5001254</p>	<p>6'</p>	<p>R&M RMYGG-U-7 IPEX 25602</p>

DESCRIPTION OF ITEM	DEPT. CODE NUMBER	SIZE	ORDERING INFORMATION
<p>Fibreglass Cable Guard - Single Riser</p> <p>Fibreglass Cable Guard - Double Riser</p> 	<p>1-34-07 5000023</p> <p>1-34-08 5000024</p>	<p>Holes for Nails to be 3/16"</p> <p>Holes for Nails to be 3/16"</p>	
<p>Plastic Riser</p>  <p>Adapter</p> 	<p>1-34-20 5000025</p> <p>1-34-25 5000026</p>	<p>2" 10 Foot U Guard</p> <p>Adapter 2" Riser</p>	
<p>Arms - Non Metallic</p>  	<p>1-36-11 5000027</p> <p>1-36-14 5000028</p>	<p>11"</p> <p>14"</p>	<p>UD RA11</p> <p>UD RA14</p>

DESCRIPTION OF ITEM	DEPT. CODE NUMBER	SIZE	ORDERING INFORMATION
<p>Arm Lock</p> 	<p>1-36-20 500029</p>		<p>UD HDL</p>
<p>Cable Rack - Non Metallic</p>  	<p>1-36-24 500030</p> <p>1-36-36 500031</p>	<p>24"</p> <p>36"</p>	<p>UD CR24-B</p> <p>UD CR36-B</p>
<p>Hook for Underground Cable Rack (See 2-20-21 for insulators)</p> 	<p>1-37-07 5001255</p> <p>1-37-10 5001256</p> <p>1-37-13 5000032</p> <p>1-37-21 5000033</p>	<p>7 1/2"</p> <p>10"</p> <p>13 1/4"</p> <p>21"</p>	<p>SL 2132 CP DU5S2</p> <p>SL 2133 CP DU5S3 MACP U625</p> <p>SMW 96022-1</p> <p>SMW 96022-2</p>

DESCRIPTION OF ITEM	DEPT. CODE NUMBER	SIZE	ORDERING INFORMATION
Eye Nut 	1-50-00 5001257 1-50-01 5001258	5/8" Thread min. eye 1 1/4" x 1 5/8" 3/4" Thread min. eye 1 1/4" x 1 5/8"	SL 7502 CP DG3E1 JOS J1092 HUH EN60 T&B K58 SL 7503 CP DG3E3 JOS J1093
Thimble Eye 	1-50-03 5001259 1-50-04 5001260	5/8" Thread 3/4" Thread	SL 7510 JOS J6510 HUB 6510 SL 7511 JOS J6511 HUB 6511
Twin Eye Double Thimble 	1-50-05 5001261	5/8" Thread	JOS J6515 HUB 6560

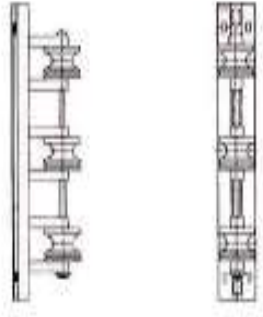

DESCRIPTION OF ITEM	DEPT. CODE NUMBER	SIZE	ORDERING INFORMATION
<p>Lock Nut</p> 	<p>1-51-01 5001262</p>	<p>3/4" Thread</p>	<p>HUB 3513 JOS J8584 HUH MF70</p>
<p>Insulator Pin Steel c/w nylon pins</p> 	<p>1-53-02 5000034</p>	<p>For Insulator with 1" Pin Hole Pin 6" above Crossarm</p>	<p>MAC P J211Z NO SUBS</p>
<p>Insulator Pin Pole Top c/w nylon pins</p> 	<p>1-53-05 5000035</p>	<p>For Insulator with 1" Pin Hole</p>	<p>JOS J26945Z</p>

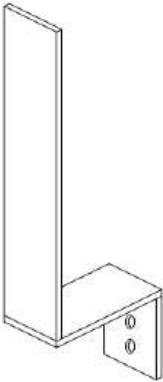
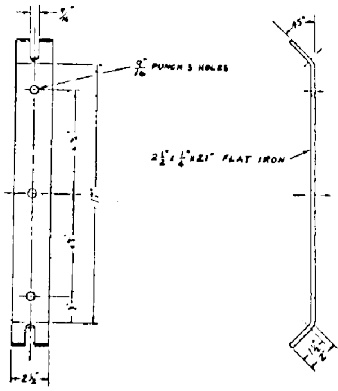
DESCRIPTION OF ITEM	DEPT. CODE NUMBER	SIZE	ORDERING INFORMATION
Insulator Pin Crossarm Corner 	1-53-09 5000036	For Insulator with 1" Pin Hole For 15 KV 8" height c/w nylon pin & locknut	PCL P402ZPCLSPL
Insulator Pin Steel 	1-53-10 5001490	1" Nylon 5/8" Female Threads	AB 4258P Mac P J2840Z
Three Spool Secondary Rack 	1-73-03 5000037		HUB C2070050

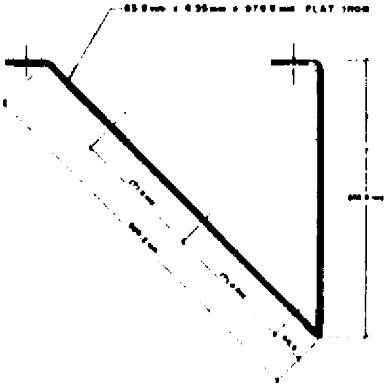
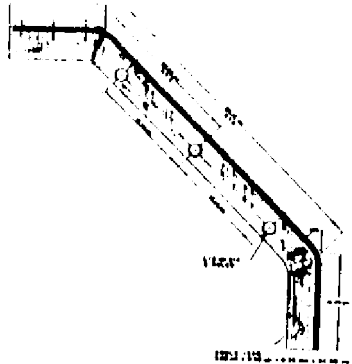
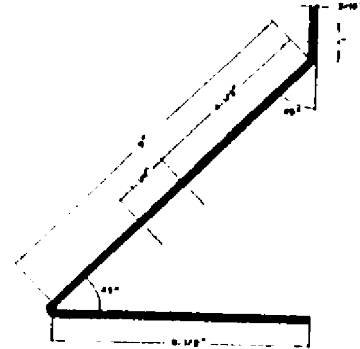

DESCRIPTION OF ITEM	DEPT. CODE NUMBER	SIZE	ORDERING INFORMATION
<p>Underground Cable Rack</p> 	<p>1-73-15 5001263</p> <p>1-73-24 5001264</p> <p>1-73-30 5001265</p>	<p>15"</p> <p>24"</p> <p>30"</p>	<p>SL 2124 HUB C203-1124</p> <p>SL 2125 HUB C203-1125 MACP U618</p> <p>SL 2126 HUB C203-1126 MACP U619 JOS J5126</p>
<p>Aluminum Fibre Optic Bracket Z Bracket</p> 	<p>1-74-00 5000038</p>		<p>SW SW250AFOB2SLP DWG A1s-273</p>
<p>Network Bus Insulator Bracket</p> 	<p>1-75-01 5000039</p>		<p>Dwg. A1S-104</p>



DESCRIPTION OF ITEM	DEPT. CODE NUMBER	SIZE	ORDERING INFORMATION
<p>Network Bus Insulator Bracket</p> 	<p>1-75-02 5000040</p>		<p>Dwg. A1S-105 Rev. 2</p>
<p>Network Bus Termination Bracket</p> 	<p>1-75-04 5000041</p>		<p>Dwg. A1S-137 Rev. 1</p>
<p>Network Ground Wire Bracket (Stainless Steel)</p> 	<p>1-75-06 5000042</p>		<p>Dwg. A1S-134</p>

DESCRIPTION OF ITEM	DEPT. CODE NUMBER	SIZE	ORDERING INFORMATION
<p>Moulding Staples</p> 	<p>1-85-02 5000043</p> <p>1-85-04 5001266</p> <p>1-85-06 5000044</p>	<p>Galvanized</p> <p>2" X 3/4" X 3/16"</p> <p>3" X 1 1/16" X 1/4"</p> <p>4" X 1 1/2" X 1/4"</p>	<p>LAR 340321</p> <p>LAR 321312 HUB C205-0220</p> <p>LAR 322522</p>
<p>Double Coil Lock Washer</p> 	<p>1-92-21 5001267</p> <p>1-92-22 5001268</p> <p>1-92-23 5001269</p>	<p>1/2" Bolt</p> <p>5/8" Bolt</p> <p>3/4" Bolt</p>	<p>JOS J176 AB C205-0185</p> <p>JOS J177 AB C205-0186</p> <p>JOS J178 AB C205-0187</p>
<p>Nut Galvanized Square</p> 	<p>1-93-13 5000045</p> <p>1-93-14 5000046</p>	<p>5/8"</p> <p>3/4"</p>	<p>MP J8563</p> <p>MP J8564</p>

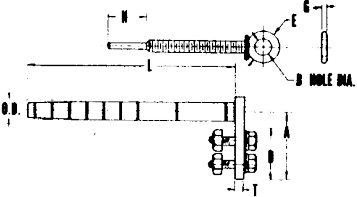

DESCRIPTION OF ITEM	DEPT. CODE NUMBER	SIZE	ORDERING INFORMATION
Split Lock Washer 	1-93-20 5001270 1-93-21 5001271 1-93-22 5001272	3/8" Bolt 1/2" Bolt 5/8" Bolt	SL 22332 CP DF7W1 SL 22333 HUB 4035 SL 22335 HUB 4036 KAB K3-3
Round Flat Washer 	1-93-30 5001273 1-93-31 5001274 1-93-32 5001275	3/8" Bolt 1/2" Bolt 5/8" Bolt	SL 7801 HUB 6801 SL 7803 HUB 6803 KAB K20-2 SL 7805 HUB 6805 KAB K20-3
Square Flat Washer 	1-93-39 5001276 1-93-40 5001277 1-93-41 5000047 1-93-42 5001278	2" x 2" x 3/16" 11/16" Hole 5/8" Bolt 2 1/4" x 2 1/4" x 3/16" 13/16" Hole 3/4" Bolt 3" x 3" x 1/4" 11/16" Hole 5/8" Bolt 3" x 3" x 1/4" 13/16" Hole 3/4" Bolt	SL 7811 HUB 6813 HYD 3622SW11 SL 7814 JOS J1076 HUB 6814 HYD 3624SW13 SL 7817 CP DF2W7 SL 7817

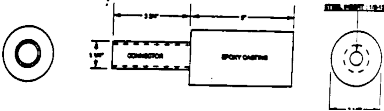
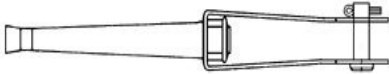



DESCRIPTION OF ITEM	DEPT. CODE NUMBER	SIZE	ORDERING INFORMATION
<p>Square Curved Washer Galvanized</p> 	<p>1-93-50 5001279</p> <p>1-93-52 5001280</p>	<p>3" x 3" x 1/4" 11/16" Hole 5/8" Bolt</p> <p>3" x 3" x 1/4" 13/16" Hole 3/4" Bolt</p>	<p>SL 7822 1/2 CP DF4W4 JOS J113 HYD 1433CW11</p> <p>SL 7825 CP DF4W5 JOS J6823</p>
<p>Nut Galvanized For Street Light Bases</p>	<p>1-94-01 5000048</p> <p>1-94-02 5000049</p>	<p>1"</p> <p>1 1/4"</p>	
<p>Washers Galvanized USS For Street Light Bases</p>	<p>1-94-11 5000050</p> <p>1-94-12 5000051</p>	<p>1"</p> <p>1 1/4"</p>	



DESCRIPTION OF ITEM	DEPT. CODE NUMBER	SIZE	ORDERING INFORMATION
Compression Deadend One Piece with Eye Fitting 	2-01-05 5000058	477 MCM ALUM	BUR YDWE331AT
Compression Deadend Two Piece with Eye Fitting 	2-01-06 5000059 2-01-08 5001487 2-01-09 5001488	266.8 MCM ACSR 336 MCM ACSR ORIOLE 477 MCM ACSR	BUR YDWE30R BUR YDWE33R BUR YTW36R36REK
Fitting - Clevis - Clevis 	2-01-12 5000060		ALMAT A180-1



DESCRIPTION OF ITEM	DEPT. CODE NUMBER	SIZE	ORDERING INFORMATION
<p>Compression Deadend Network Bus</p> 	<p>2-01-15 5000061</p>	<p>750 MCM Copper</p>	<p>Multicast Inc. Dwg. #A215-011</p>
<p>Automatic Deadend</p> 	<p>2-01-20 5000062</p>	<p>4/0 ALUM or ACSR</p>	<p>FAR GD449</p>
<p>Service Wedge Clamp</p> 	<p>2-02-14 5001283</p>	<p>#2 - #6</p>	<p>BLK W621 MACP 7195</p> <p>NO SUBS</p>

DESCRIPTION OF ITEM	DEPT. CODE NUMBER	SIZE	ORDERING INFORMATION
<p>Deadend Strain Clamp (Hot Line) Steel: (For copper conductor only)</p> 	<p>2-02-15 5000063</p> <p>2-02-16 5001284</p>	<p>#4 STR - 2/0 STR(19) 0.204 - 0.563</p> <p>4/0 STR 0.250 - 0.730 0.300 - 0.630</p>	<p>MACP HDSO-47-F NO SUBS</p> <p>CON SDE-73F EPAC MSC-62</p>
<p>Deadend Strain Clamp (Hot Line) Aluminum (For alum & ACSR conductor only)</p> 	<p>2-02-17 5001285</p> <p>2-02-18 5001286</p>	<p>#2 STR - 2/0 STR (19) 0.250 - 0.447 0.250 - 0.460 0.160 - 0.460 0.180 - 0.520</p> <p>4/0 ALUM - 477 MCM ALUM 0.522 - 0.813 0.460 - 0.860 0.522 - 0.811 0.310 - 0.880</p>	<p>BUR CUW26RE SL 62312 EPAC ASC50 CON SGA-52-23 MACP ASD 2L N</p> <p>MACP HDSO-88 HUB ADEZ88N</p> <p>NO SUBS</p>
<p>Preformed Deadend Grip For Quad & Triplex Only</p> 	<p>2-02-20 5001287</p> <p>2-02-21 5001288</p>	<p>2/0 ACSR Messenger</p> <p>4/0 ACSR Messenger</p>	<p>AB CSG-080 PAY 21-SSG SL 15141 BM 21GSDE-401-450 HEL 60800</p> <p>AB CSG-100 PAY 26-SSG SL 15143 BM 26GSDE-511-580 HEL 60910</p>

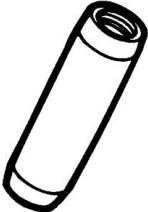
DESCRIPTION OF ITEM	DEPT. CODE NUMBER	SIZE	ORDERING INFORMATION
<p>Preformed Deadend Grip</p> 	<p>2-02-22 5001289</p> <p>2-02-24 5001290</p> <p>2-02-25 5001291</p>	<p>2/0 ACSR Bare Dia .447 Range .410-.447 Coded Brown or Blue</p> <p>2/0 AAC Poly SB Dia .502 Range .461-.516 Coded Orange</p> <p>2/0 ACSR Poly SB Dia .535 Range .517-.577 Coded Purple or Red</p>	<p>SL 80004 AB 60AWCG PAY QUAIL-31-ADN HEL 31022</p> <p>AB 70GCG PAY THORN32NADN BM DG-2516 HEL 30030</p> <p>AB 80GCG PAY CORYPHA-35NADN BM DG-2517 HEL 30033</p>
<p>Preformed Deadend Grip</p> 	<p>2-02-26 5001292</p> <p>2-02-27 5001293</p> <p>2-02-29 5001294</p>	<p>4/0 ACSR Bare Dia .563 Range .542-.563 Coded Black or Red</p> <p>4/0 ACSR Poly AAC Range .578 - .653 Coded Blue</p> <p>336.4 MCM AAC Poly Dia- .791 Range .740-.837 Coded Brown Coded Pink/Green</p>	<p>AB 80AWCG PAY PENGUIN37ADN HEL 31033</p> <p>BM DG-2100 HEL 30040 HXU 30040-BC</p> <p>AB 110GCG PAY ANONA-40-NADN BM DG-2102 HXU 36030-MH HEL 36030</p>
<p>Preformed Deadend Grip</p> 	<p>2-02-30 5001295</p>	<p>477 MCM AAC Poly Dia .951 Range .948-1.071 Coded Black</p>	<p>AB 130GCG PAY HUCKLE-BERRY-40-NADN HEL 36033</p>

DESCRIPTION OF ITEM	DEPT. CODE NUMBER	SIZE	ORDERING INFORMATION
<p>Suspension Clamp Ground Wire</p>  <p>Shield Wire</p>  <p>AL 266-477</p>	<p>2-02-33 5000064</p> <p>2-02-35 5024978</p> <p>2-02-36 5024980</p>		<p>SL 6455</p> <p>MAC P FSC-83</p> <p>MAC P LS-2-S</p>
<p>AGS Unit c/w Clamp and Structural Rod</p> <p>Replacement Structural Rod 2-56-13</p> <p>Replacement Structural Rod 2-56-15</p> 	<p>2-02-44 5000065</p> <p>2-02-45 5000066</p>	<p>266.8 ACSR Range 0.620-0.645</p> <p>477 ACSR Range 0.346-0.870</p>	<p>PLP AGS-5108 c/w Socket Eye SE-5150</p> <p>PLP AGS-5118</p>
<p>Ground Rod Clamp</p> 	<p>2-02-50 5001296</p> <p>2-02-51 5001297</p>	<p>Rod Diameter 5/8"</p> <p>3/4"</p>	<p>AMP 81402-1 ILS BGRC-58 HYD 758C PP 8058 BUR GRC58 HUB GC-5/G5</p> <p>AMP 81403-1 ILS BGRC-68 PP 8034 HYD 733C BUR GR3426</p>



DESCRIPTION OF ITEM	DEPT. CODE NUMBER	SIZE	ORDERING INFORMATION
<p>Ground Rod Coupling Connector Bronze</p> 	<p>2-02-53 5001298</p>	<p>5/8"</p>	<p>BLK 60C SL 9534 JOS 9182 HYD 58.SC PP 8534</p>
<p>Ground Rod Driving Stud</p> 	<p>2-02-55 5001299</p>		<p>SL 29534 BLK 60DS JOS 9186 HYD 58.DS PP 19534</p>
<p>Copperclad Steel Sectional Ground Rod</p> 	<p>2-02-57 5001300</p>	<p>5/8" x 8'</p>	<p>SL 29438 JOS 9158 HYD 5808.SC PP 18438 BLK 6258S CAD 635880</p>

DESCRIPTION OF ITEM	DEPT. CODE NUMBER	SIZE	ORDERING INFORMATION
<p>Hot Line Clamp For Alum/Cu Main Line Conductor With #4 AWG Cu Tap</p> <p>For Armoured Main Line Conductor With #4 AWG Cu Tap</p> 	<p>2-03-00 500067</p> <p>2-03-01 500068</p> <p>2-03-02 500069</p>	<p>1/0 to #6 AWG</p> <p>336.4 MCM to #6 AWG</p> <p>266.8 MCM to #4 AWG</p>	<p>AB S1520AGP</p> <p>AB S1530AGP</p> <p>AB S1540AGP</p>
<p>Bull Line - Poly Pull Tape</p> 	<p>2-04-10 5001301</p>	<p>1800# X 900 Meter Box</p>	<p>DL WP18-3000 GRNL 4436</p>
<p>Aluminum Oxidation Inhibitor Splicing Compound (Penetrox)</p> 	<p>2-05-12 5001302</p>	<p>8 oz. Bottle</p>	<p>AMP 80665-3 BUR Pena 138 T&B CTB8 ILS DE-OX 8OZ</p>



DESCRIPTION OF ITEM	DEPT. CODE NUMBER	SIZE	ORDERING INFORMATION
<p>Cable Pulling Lubricant</p> 	<p>2-05-14 500070</p> <p>2-05-16 500071</p> <p>2-05-18 500072</p>	<p>1 Quart</p> <p>5 Gallon</p> <p>5 Gallon Winter Grade</p>	<p>POLYWATER J-35 NO SUBS</p> <p>POLYWATER J-640 NO SUBS</p> <p>POLYWATER WJ-640 NO SUBS</p>
<p>Switch Contact Lubricant 7 Release Compound</p> 	<p>2-05-19 500073</p>	<p>150 Gram</p>	<p>Dow Corning Dow 7</p>
<p>Termi Kit Silicone Lubricant</p> 	<p>2-05-25 500074</p>	<p>5 oz. Tube</p>	<p>ELMD SL5</p>

DESCRIPTION OF ITEM	DEPT. CODE NUMBER	SIZE	ORDERING INFORMATION
STOPAQ Sealant 	2-05-30 5000075	.53 kg Tube	STO FN2100-2002
Solid Blade Cutout 	2-11-72 5000076	300 Amp 15 KV	ABB Y2JCBNVA32
Open Fuse Loadbreak Cutout 	2-11-84 5001303 2-11-88 5001304 2-11-92 5001305 2-11-94 5001306	100 Amp 15 KV 16,000 Interrupting 200 Amp 15 KV 100 Amp 14.4 - 25 KV 200 Amp 25 KV	ALUM CSG15LX-100A-110-CB-16KA ABB Y1JCBNQA11 AB CP730114PB ALUM CSG15LX-200A-110-CB-12KA ABB Y1JCBNUA21 AB CP730143PB ALUM CSG27LX-100A-125-CB-16KA ABB Y2JCBNQA12 AB CP730213PB ALUM CSG27LX-200A-125-CB-10KA ABB Y2JCBNFA22 AB CP730242PB

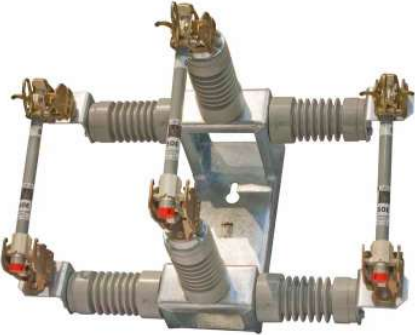
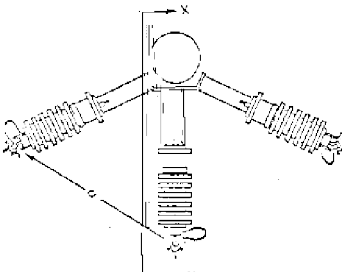

DESCRIPTION OF ITEM	DEPT. CODE NUMBER	SIZE	ORDERING INFORMATION
<p>Solid Blade Enclosed Cutout</p> 	<p>2-12-06 5001307</p>	<p>400 Amp 5.2 KV</p>	<p>GE 9F36CAM406 CP FE1EC7</p>
<p>Replacement Solid Blade Door for 2-12-06</p> 	<p>2-12-08 5000077</p>	<p>400 Amp 5.2 KV</p>	<p>CP FE1EC57</p>
<p>Solid Blade Disconnect</p> 	<p>2-12-30 5000078</p> <p>2-12-32 5000079</p>	<p>600 Amp 15 KV</p> <p>600 Amp 25 KV</p>	<p>S&C 4922R10-ED1</p> <p>S&C 4943R10-ED1</p>

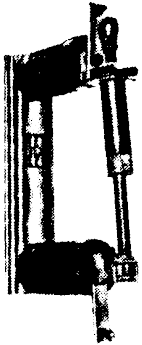
DESCRIPTION OF ITEM	DEPT. CODE NUMBER	SIZE	ORDERING INFORMATION
<p>Line Tension Disconnect - Pad Style</p>  <p>Line Tension Disconnect - Ampact Style</p> 	<p>2-12-34 500080</p> <p>2-12-36 502532</p> <p>2-12-38 5025364</p>	<p>600 Amp 25 KV</p> <p>900 Amp, 25 KV 4/0 266 & 336 MCM</p> <p>900 Amp 25 KV 477 MCM</p>	<p>AB ALTD06200R</p> <p>TE 1710726-2</p> <p>TE 1710726-3</p>
<p>Three Phase Cluster Style Mounting Unit</p>  <p>Uses 7-41-40 fuses - Qty 3 per cluster</p>	<p>2-12-40 500081</p>	<p>SMD-40</p>	<p>S&C 192342-E</p>
<p>Solid Blade Disconnect Three Phase Cluster c/w - Cyproxy insulators, 90 degree stop, clamp type terminals</p> 	<p>2-12-44 500082</p>	<p>900 Amp 25 KV</p>	<p>Mindcore DHS327A7 Specification 1270</p>

DESCRIPTION OF ITEM	DEPT. CODE NUMBER	SIZE	ORDERING INFORMATION
<p>Insulator Insert in Operating Shaft</p> 	<p>2-12-49 500083</p>	<p>Critical Spare Only</p>	
<p>Three Phase Group Operated Switch Horizontal Mounting c/w Wildlife Protection</p> 	<p>2-12-50 500084</p> <p>2-12-51 500085</p>	<p>600 Amp 15 KV</p> <p>600 Amp 25 KV</p>	<p>S&C 147422R4-P1W c/w ED-701R4-S2 Specification 100 No Alternates</p> <p>S&C 147423R4-H Specification 104</p>
<p>Three Phase Group Operated Switch Vertical Mounting</p> 	<p>2-12-52 500086</p> <p>2-12-53 500087</p>	<p>600 Amp 15 KV</p> <p>600 Amp 25 KV</p>	<p>S&C 147512 ED703R2-S2S15 Specification 102</p> <p>S&C 147513 ED703R2-S2S15 Specification 106</p>

DESCRIPTION OF ITEM	DEPT. CODE NUMBER	SIZE	ORDERING INFORMATION
<p>Indoor Fused Disconnect</p> 	<p>2-13-02 500088</p>	<p>200 Amp 4.8 KV</p>	<p>S&C SM487360R1</p>
<p>Indoor Fused Cutout Type NX</p> 	<p>2-13-06 500089</p>	<p>200 Amp 8.3 KV</p>	<p>CP FA1D1</p>
<p>Lightning Arrestor Distribution Class c/w Ground Lead Insulator</p> <p>Metal Oxide Type c/w Polymer Housing</p> 	<p>2-16-03 5001308</p> <p>2-16-12 5001309</p> <p>2-16-18 5001310</p>	<p>3 KV</p> <p>12 KV</p> <p>18 KV</p>	<p>MACZHP003-0C00100 GE 9L23AXA403AH HUB 2137037324 CP UHS03030A1A1B1A</p> <p>HUB 2137107324 GE 9L23AXA412AH MACZHP012-0C00100 CP UHS12060A1A1B1A</p> <p>HUB 213715-7324 CP UHS18080A1A1B1A</p>

DESCRIPTION OF ITEM	DEPT. CODE NUMBER	SIZE	ORDERING INFORMATION
<p>Pin Type Insulator Polymer</p> 	<p>2-17-20 500090</p>	<p>15 - 25 KV 1" Hole</p>	<p>Hendrix HPI55501</p>
<p>Pin Type Insulator - Clamp Top Polymer</p> 	<p>2-17-30 5001491</p>	<p>25 KV</p>	<p>HendrixHPI-25VTP-1 PLP IP-25-VTU1</p>
<p>Shear Bolt for Clamp Top Insulator</p>	<p>2-17-35 5001492</p>	<p>25 KV</p>	<p>Hendrix B-1 NO SUBS</p>

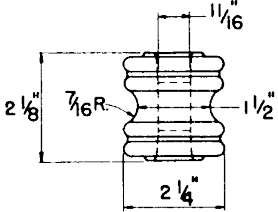
DESCRIPTION OF ITEM	DEPT. CODE NUMBER	SIZE	ORDERING INFORMATION
<p>Guy Strain Insulator Colored</p> 	<p>2-18-01 5001311</p> <p>2-18-03 5001312</p>	<p>4.4 KV 12000 lbs.</p> <p>6.6 KV 20000 lbs.</p>	<p>NGK HCP-191 PP 504 OB 31504 BM 504</p> <p>NGK HCP-192 PP 506 OB 31506 BM 506</p>
<p>Large Clevis Type Insulator Spool Polymer Black</p>  <p>Light Grey</p> 	<p>2-18-11 5000091</p> <p>2-18-13 5000092</p>	<p>Large Sec Volt 2500 lbs. 13/16" Hole</p> <p>Large Sec Volt 2500 lbs. 13/16" Hole</p>	<p>HUB C9091032P</p> <p>Hendrix HPI-53-2</p>
<p>Small Clevis Type Insulator Colored</p> <p>White</p> 	<p>2-18-27 5001313</p> <p>2-18-39 5001314</p>	<p>Small Sec Volt 2000 lbs. 11/16" Hole</p> <p>Small Sec Volt 2000 lbs. 11/16" Hole</p>	<p>SL 1608 NGK HRP-614 PP 5112 ANSI 53-1</p> <p>SL 1608 NGK HRP-614 PP 5112 ANSI 53-1 White</p>

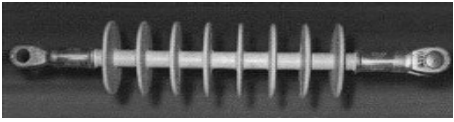

DESCRIPTION OF ITEM	DEPT. CODE NUMBER	SIZE	ORDERING INFORMATION
<p>Suspension Insulator Clevis Eye</p> 	<p>2-19-01 5001315</p>	<p>10000 lbs. 7.2 KV</p>	<p>NGK CA-15923A OB 32433 PP 86012 LAPP 6605-70</p>
<p>Ball & Socket Insulator Suspension</p> 	<p>2-19-05 5001316</p>	<p>72 & 138 KV 15000 lbs.</p>	<p>SED N70/146 HUB PCN70146</p>
<p>Ball & Socket Insulator Strain</p> 	<p>2-19-07 5001317</p>	<p>72 & 138 KV 25000 lbs.</p>	<p>SED N12/146 HUB PCN12146</p>

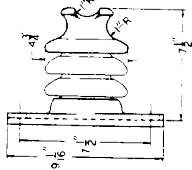
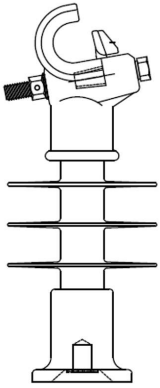

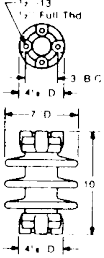
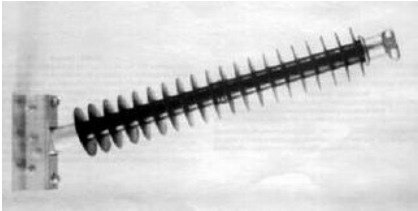
DESCRIPTION OF ITEM	DEPT. CODE NUMBER	SIZE	ORDERING INFORMATION
<p>Epoxy Deadend Insulator Eye-Clevis End</p>  <p>Eye-Eye End</p>	<p>2-19-30 5001318</p> <p>2-19-32 5001319</p>	<p>10000 lbs. 4 KV, 15 KV & 25 KV</p> <p>10000 lbs. 15 KV & 25 KV</p>	<p>KL KL28ASCTM PER RL-25 LAPP 151002 OB PDI-28 AB 401028-6215 SED ODI-1S-70-Z8 GLP DS-28 SAL 9502U-SI</p> <p>AB 401428-6215 PER RL-25 KL KL28ASTTM LAPP 151002E</p>
<p>Phase Conduction Spacing Insulator</p>	<p>2-19-44 5000093</p>	<p>25 KV Conductor range .20 - .858" c/w 2 clamps</p>	<p>EPAC EHCS-2-3545 45" Length</p>
<p>Polymer Insulator Suspension</p>	<p>2-19-50 5000094</p>	<p>10,000 lbs 138 KV</p>	<p>NGK 251-SN270-YT</p>

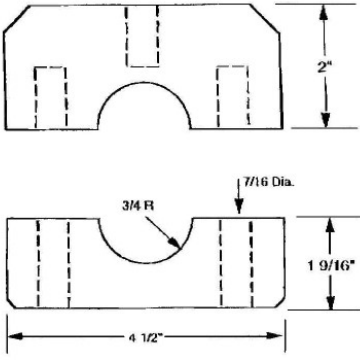

DESCRIPTION OF ITEM	DEPT. CODE NUMBER	SIZE	ORDERING INFORMATION
Polymer Insulator Deadend	2-19-60 500095	25,000 lbs. 138 KV	NGK 302-SS550-YC
Line Post Insulator 	2-20-01 500096	15 KV	LAPP 74115
Polymer Line Post Insulator 	2-20-02 500097	28 KV	K-Line KL28SKG

DESCRIPTION OF ITEM	DEPT. CODE NUMBER	SIZE	ORDERING INFORMATION
Polymer Line Post Insulator	2-20-04 5000098	15 KV	
Station Post Insulator for S & C 600 Amp Loadbreak Switches 	2-20-05 5001320	15 KV	OB 231002 NGK DA-45006A
Polymer Line Post Insulator 	2-20-06 5000099 2-20-07 5000100	138 KV 1150 lb MDCL Flat Base 138 KV 1150 lb MDCL Gain Base	MACP H211075VX06 MACP H291075VX06

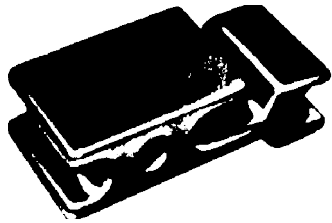

DESCRIPTION OF ITEM	DEPT. CODE NUMBER	SIZE	ORDERING INFORMATION
Station Post Insulator 650KV Bil	2-20-08 5000101	138 KV Height = 54"	NGK Locke PS06510 Specification 3304
Corona Ring	2-20-09 5000102	138 KV	NGK 97004-RG
Cable Cleats Single Cable Clamp 	2-20-11 5000103 2-20-13 5000104	26 mm - 38 mm 36 mm - 52 mm	KOZ 26-38 KOZ 36-52

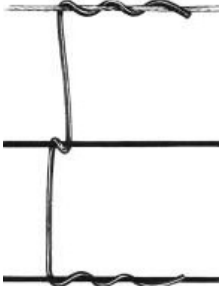

DESCRIPTION OF ITEM	DEPT. CODE NUMBER	SIZE	ORDERING INFORMATION
<p>Cable Cleats Three Cable Clamp</p>  <p>Multi Cable Clamp</p> 	<p>2-20-15 5000105</p> <p>2-20-17 5000106</p> <p>2-20-19 5000107</p>	<p>25 mm - 40 mm</p> <p>38 mm - 53 mm</p> <p>30 mm - 47 mm</p>	<p>KOZ Triangle 25-40 3 Hole</p> <p>KOZ Triangle 38-53 3 Hole</p> <p>KOZ Universal 30-47</p>
<p>Insulator Cable Rack Type</p> 	<p>2-20-21 5001321</p>	<p>Polymer</p>	<p>SL 2120 CP DE11U1 MACP U628 ENE 3003</p>
<p>Epoxy Insulator Split Spool Moulded for Network</p> 	<p>2-20-23 5000108</p>	<p>1 1/2"</p>	<p>MULT A215-009</p>

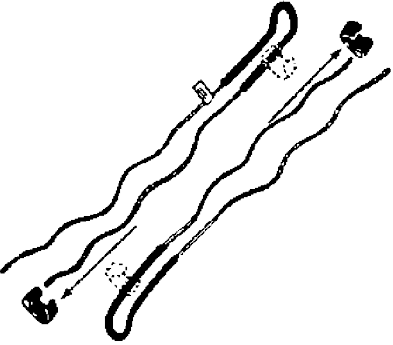
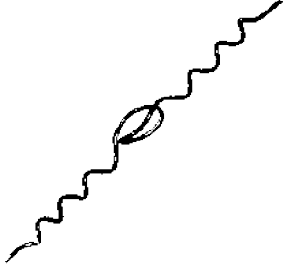
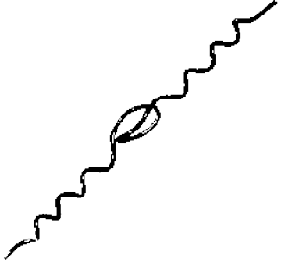
DESCRIPTION OF ITEM	DEPT. CODE NUMBER	SIZE	ORDERING INFORMATION
Insulator Triplex Spreader Block 	2-20-25 5000109		SL 1750
Insulator Indoor for Switching Cubicle	2-20-27 5001322	15.5 KV (95 KV BIL)	CP FM2A1 or FW14XC1
Black Plastic Moulding 	2-27-08 5001323	1/2" x 8'	LAC 755P NE 125 POL P128PM

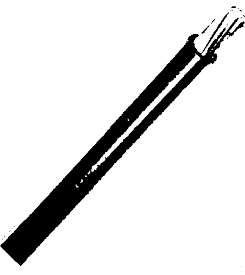

DESCRIPTION OF ITEM	DEPT. CODE NUMBER	SIZE	ORDERING INFORMATION
<p>Preformed Plastic Line 1/2" Construction</p> 	<p>2-55-01 5001326</p> <p>2-55-02 5001327</p> <p>2-55-03 5001328</p>	<p>OD .270-.350 OD .257-.523</p> <p>OD .644-.872 OD .522-.770 OD .724-1.030</p> <p>OD .414-.644</p>	<p>PLP PSU-MS-2682 ENE 2711</p> <p>PLP PSU-MS-2762 ENE 2730 ENE 2731</p> <p>FAR GS-953 ENE 2742</p>
<p>Structural Rod Replacement for AGS Unit Only</p> <p>Use with 2-02-44</p> <p>Use with 2-02-45</p> 	<p>2-56-13 5000113</p> <p>2-56-15 5000114</p>	<p>266.8 ACSR</p> <p>477 ACSR</p>	<p>PLP 4000108</p> <p>PLP 4000118</p>
<p>Armour Rod (Shield Wire)</p>	<p>2-56-20 5000115</p> <p>2-56-25 5000116</p>	<p>5/16" Steel Range 0.309"-0.326"</p> <p>7/16" Steel Range 0.416-0.436" (Use for #1/0 AWAC 5/2 Alumoweld)</p>	<p>PLP AR-1128</p> <p>PAY Aster-52-A</p>

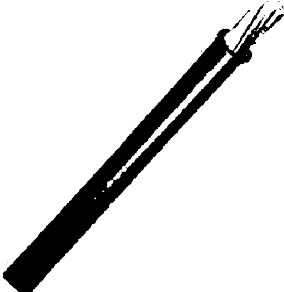
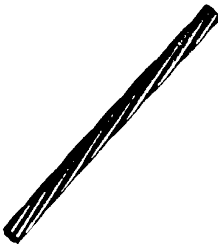

DESCRIPTION OF ITEM	DEPT. CODE NUMBER	SIZE	ORDERING INFORMATION
Preformed Super Top Tie 	2-58-00 5000117	2/0 ACSR Bare Blue	AB STT-70
	2-58-02 5000118	4/0 ACSR Bare Pink	AB STT-90
	2-58-04 5000119	336.4 MCM Alum Bare & ACSR Bare Brown	AB STT-110
	2-58-06 5000120	477 MCM Alum Bare & ACSR Bare Purple	AB STT-120
Nonmetallic Composite Insulator Top Tie 	2-58-10 5000121	#2 & #4 Poly Copper "F" Neck Small White/Yellow (4KV & 15 KV Glass)	FAR GJ-611FC NO SUBS
	2-58-11 5000122	#2 & #4 Poly Copper "J" Neck Large White/Yellow (25 KV Glass)	FAR GJ-621FC NO SUBS
	2-58-12 5000123	2/0 ACSR Poly 2/0 Poly Copper "F" Neck Small Green/Yellow	FAR GJ-612FC NO SUBS
Nonmetallic Composite Insulator Top Tie 	2-58-13 5000124	4/0 Poly Copper "F" Neck Small Blue/Yellow	FAR GJ-613FC NO SUBS
	2-58-14 5000125	336 MCM Poly Alum "F" Neck Small Orange/Yellow	FAR GJ-614FC NO SUBS
	2-58-15 5000126	336 MCM Poly Alum "J" Neck Large Orange/Yellow	FAR GJ-624FC NO SUBS

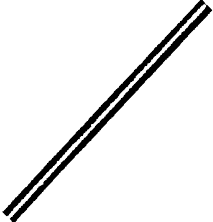
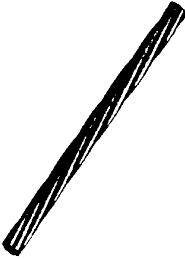
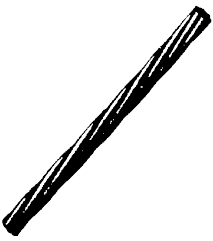
DESCRIPTION OF ITEM	DEPT. CODE NUMBER	SIZE	ORDERING INFORMATION
<p>Damper Spiral Shield Wire</p> 	<p>2-58-20 5000127</p> <p>2-58-26 5000128</p>	<p>for 5/16" Steel</p> <p>for .416" Dia AWAC Conductor</p>	<p>PLP 5050103</p> <p>PLP 5050104</p>
<p>Damper Stockbridge</p> 	<p>2-58-30 5000129</p> <p>2-58-36 5000129</p>	<p>5/16" - 3/8" Steel Range 0.250" - 0.385"</p> <p>477 MCM ACSR Hawk Range 0.266"-0.865"</p>	<p>FAR 60704-8/0</p> <p>FAR 60705-10/11 DULM DB1-18</p>
<p>Copper Conductor MHD Poly Covered (Coils)</p>  <p>Copper Conductor MHD Poly Covered (Reel)</p>	<p>2-60-05 5000130</p> <p>2-60-06 5000131</p> <p>2-60-08 5000132</p>	<p>#4 Solid</p> <p>#2 Solid</p> <p>#2 Solid</p>	<p>Specification #1308 150 M Coils</p> <p>Specification #1308 150 M Coils</p> <p>Specification #1308 500 M Reel</p>

DESCRIPTION OF ITEM	DEPT. CODE NUMBER	SIZE	ORDERING INFORMATION
<p>Copper Conductor Soft Poly Covered (Overhead Transformer Leads)</p> 	<p>2-61-09 5000133</p> <p>2-61-11 5000134</p>	<p>2/0 Stranded</p> <p>4/0 Stranded</p>	<p>Specification #1310</p> <p>Specification #1310</p>
<p>Copper Conductor Soft Bare (Coils)</p> <p>Stranded</p> 	<p>2-63-05 5000135</p>	<p>#4</p>	<p>Specification #1318 150 M Coils</p>
<p>Aluminum Conductor Poly Covered</p> <p>Stranded</p> 	<p>2-65-11 5000136</p> <p>2-65-13 5000137</p> <p>2-65-14 5000138</p>	<p>4/0</p> <p>336 MCM</p> <p>477 MCM</p>	<p>Specification #1312</p> <p>Specification #1312</p> <p>Specification #1312</p>

DESCRIPTION OF ITEM	DEPT. CODE NUMBER	SIZE	ORDERING INFORMATION
Aluminum Conductor Solid Bare Tie Wire 	2-66-00 5000139	#4	
Aluminum Conductor Bare Stranded 	2-66-08 5017889 2-66-11 5000140 2-66-13 5000141 2-66-14 5000142	1/0 4/0 336 MCM 477 MCM Cosmos	Specification #1316 Specification #1316 Specification #1316 Specification #1316
Aluminum Conductor Steel Reinforced Bare Stranded 	2-68-09 5000143 2-68-11 5000144 2-68-12 5000145 2-68-14 5000146	2/0 4/0 266.8 MCM 477 MCM Hawk	Specification #1320 Specification #1320 Specification #1320 Specification #1320

DESCRIPTION OF ITEM	DEPT. CODE NUMBER	SIZE	ORDERING INFORMATION
Duplex SB Stranded 	2-69-04 5000147	#6	Specification #1302 & Addendum
Triplex SB Stranded 	2-70-05 5000148 2-70-06 5000149 2-70-09 5000150 2-70-11 5000151	#4 #2 2/0 4/0	Specification #1304 & Addendum 150 M Coils Specification #1304 & Addendum 100 M Coils Specification #1304 & Addendum 300 M Reel Specification #1304 & Addendum 300 M Reel
Quadriplex SB Stranded 	2-71-06 5000152 2-71-09 5000153 2-71-11 5000154	#2 2/0 4/0	Specification #1306 & Addendum 100 M Coils Specification #1306 & Addendum 300 M Reel Specification #1306 & Addendum 300 M Reel

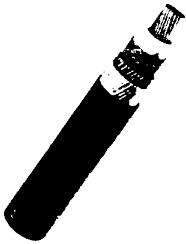
DESCRIPTION OF ITEM	DEPT. CODE NUMBER	SIZE	ORDERING INFORMATION
<p>Copper Cable 25 KV Concentric Neutral</p> <p>Stranded</p> 	<p>2-73-07 5000155</p> <p>2-73-14 5000156</p>	<p>#1</p> <p>500 MCM 33%</p>	<p>Specification #2316 & Addendum</p> <p>Specification #2316 & Addendum</p>
<p>Copper Cable 15 KV Shielded 1 Conductor</p> <p>Stranded</p> 	<p>2-74-16 5000157</p>	<p>1000 MCM</p>	<p>Specification #2322 & Addendum</p>
<p>Copper Cable 15 KV Concentric Neutral</p> <p>Stranded</p> 	<p>2-75-07 5000158</p> <p>2-75-12 5000159</p> <p>2-75-14 5001330</p> <p>2-75-15 5000160</p>	<p>#1</p> <p>250 MCM 33%</p> <p>500 MCM 33% 4.025 kg/m</p> <p>750 MCM 33% 5.630 kg/m</p>	<p>Specification #2316 & Addendum</p> <p>Specification #2316 & Addendum</p> <p>Specification #2316 & Addendum</p> <p>Specification #2316 & Addendum</p>

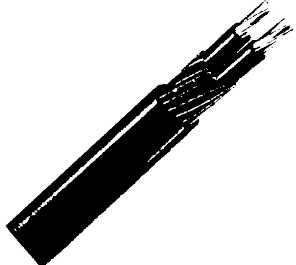
DESCRIPTION OF ITEM	DEPT. CODE NUMBER	SIZE	ORDERING INFORMATION
<p>Aluminum Cable 600 Volt XLPE Twisted Individual Conductors USEI90</p> 	<p>2-82-02 5020779</p> <p>2-82-10 5023025</p>	<p>#6 3 Conductor</p> <p>1/0-3C</p>	<p>Specification #2315 & Addendum</p>
<p>Copper Cable 600 Volt XLPE Concentric Neutral</p> <p>Stranded</p>	<p>2-83-04 5000161</p>	<p>#6 1 Conductor</p>	<p>Specification #2306 & Addendum</p>
<p>Copper Cable 600 Volt XLPE Concentric Neutral</p> <p>Stranded</p> 	<p>2-84-09 5000162</p> <p>2-84-11 5000163</p>	<p>2/0 2 Conductor & Neutral</p> <p>4/0 2 Conductor & Neutral</p>	<p>Specification #2308 & Addendum</p> <p>Specification #2308 & Addendum</p>

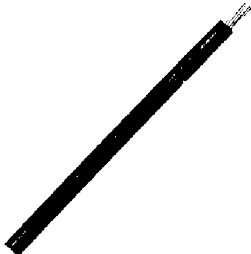
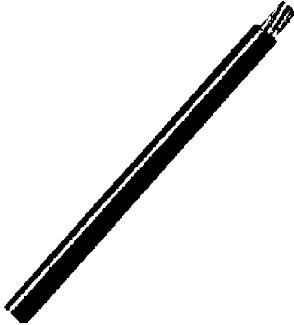

DESCRIPTION OF ITEM	DEPT. CODE NUMBER	SIZE	ORDERING INFORMATION
<p>Copper Cable 600 Volt XLPE Twisted Individual Conductors USEI90</p> 	<p>2-85-02 5000164</p> <p>2-85-03 5000165</p> <p>2-85-04 5000166</p> <p>2-85-05 5000167</p>	<p>#6 3 Conductor</p> <p>#6 4 Conductor</p> <p>#2 3 Conductor</p> <p>#2 4 Conductor</p>	<p>Specification #2312 & Addendum</p> <p>Specification #2312 & Addendum</p> <p>Specification #2312 & Addendum</p> <p>Specification #2312 & Addendum</p>
<p>Copper Cable 600 Volt XLPE Twisted Individual Conductors USEI90</p> 	<p>2-85-06 5000168</p> <p>2-85-08 5000169</p> <p>2-85-14 5000170</p>	<p>2/0 3 Conductor</p> <p>4/0 3 Conductor</p> <p>500 MCM 4 Conductor</p>	<p>Specification #2312 & Addendum</p> <p>Specification #2312 & Addendum</p> <p>Specification #2312 & Addendum</p>
<p>Network Cable 600 Volt XLPE Stranded</p>	<p>2-85-21 5000171</p> <p>2-85-22 5000172</p> <p>2-85-23 5000173</p> <p>2-85-31 5000174</p>	<p>500 MCM Red 1 Conductor</p> <p>500 MCM Yellow 1 Conductor</p> <p>500 MCM Blue 1 Conductor</p> <p>750 MCM</p>	<p>Specification #2310 & Addendum</p> <p>Specification #2310 & Addendum</p> <p>Specification #2310 & Addendum</p> <p>Specification #2314 & Addendum</p>

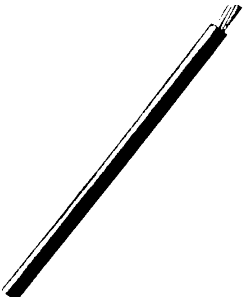
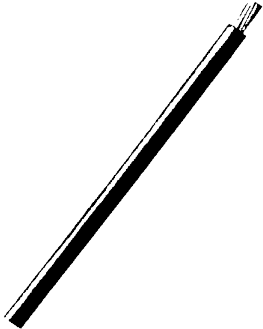
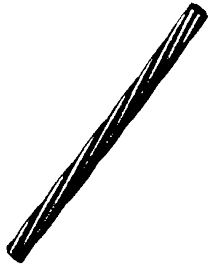

DESCRIPTION OF ITEM	DEPT. CODE NUMBER	SIZE	ORDERING INFORMATION
<p>Copper Cable 1000 Volt RWU 90, XLPE</p> <p>Stranded</p> 	<p>2-87-04 5000175</p> <p>2-87-06 5000176</p> <p>2-87-09 5000177</p> <p>2-87-11 5000178</p>	<p>#6</p> <p>#2</p> <p>2/0</p> <p>4/0</p>	<p>Specification #2304 & Addendum</p> <p>Specification #2304 & Addendum</p> <p>Specification #2304 & Addendum</p> <p>Specification #2304 & Addendum</p>
<p>Copper Cable 600 Volt RW90 or Equivalent -40 degrees C. Rated, Standard Stranded Street Light Wire</p> 	<p>2-87-51 5000179</p> <p>2-87-52 5000180</p>	<p>#12 Black</p> <p>#12 White</p>	
<p>Control Cable 90 degrees C. PVC Jacket 600 Volt</p>	<p>2-88-02 5016467</p> <p>2-88-04 5016466</p> <p>2-88-07 5000181</p>	<p>#12 2 Conductor</p> <p>#12 4 Conductor</p> <p>#12 7 Conductor</p>	<p>Specification #3306</p> <p>Specification #3306</p> <p>Specification #3306</p>

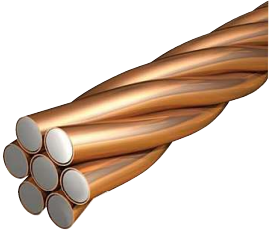
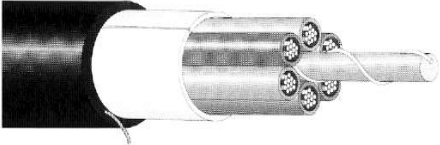
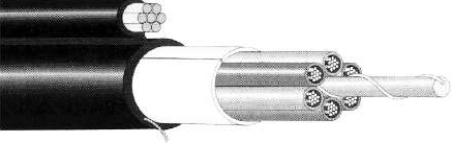
DESCRIPTION OF ITEM	DEPT. CODE NUMBER	SIZE	ORDERING INFORMATION
Control Cable 90 degrees C. PVC Jacket 600 Volt	2-88-16 5000182 2-88-22 5000183	#20 6 Pair #20 12 Pair	Specification #3308 Specification #3308
Communication Cable RS - 485	2-88-40 5000184	CAT 6 Ethernet Cable	
Switchgear Cable	2-88-60 5000185	#12 AWG 65 Str	S1S 12-65 STR

DESCRIPTION OF ITEM	DEPT. CODE NUMBER	SIZE	ORDERING INFORMATION
Metering Coded Wire 600 Volt TWH 7 Strand 	2-89-00 500186 2-89-01 500187 2-89-02 500188 2-89-03 500189	#12 Yellow #12 Red #12 Blue #12 Green	NEX 12CU STR YEL NEX 12CU STR RED NEX 12CU STR BLU NEX 12CU STR GRN
Metering Coded Wire 600 Volt TWH 7 Strand 	2-89-05 500190 2-89-06 500191 2-89-07 500192 2-89-08 500193 2-89-09 500194 2-89-10 500195	#12 Red/Black Stripe #12 Red/White Stripe #12 Yellow/Black Stripe #12 Yellow/White Stripe #12 Blue/Black Stripe #12 Blue/White Stripe	SYC 12CU STR R/B SYC 12CU STR R/W SYC 12CU STR Y/B SYC 12CU STR Y/W SYC 12CU STR BLU/B SYC 12CU STR BLU/W
Copper Conductor Soft Bare (Reels) Stranded 	2-90-04 500196 2-90-05 500197 2-90-06 500198 2-90-09 500199 2-90-13 500200 2-90-14 500201	#6 #4 #2 2/0 350 MCM 500 MCM	Specification #2302 & Addendum Specification #2302 & Addendum Specification #2302 & Addendum Specification #2302 & Addendum Specification #2302 & Addendum

DESCRIPTION OF ITEM	DEPT. CODE NUMBER	SIZE	ORDERING INFORMATION
<p>Copperclad Steel Groundwire Copperweld 7 Stranded</p> 	<p>2-91-00 5000202</p>	<p>2/0</p>	
<p>Fibre Optic Cable Single Mode, Indoor/Outdoor, Riser Rated</p> 	<p>2-92-00 5000203</p> <p>2-92-10 5000204</p>	<p>48 Fibres</p> <p>96 Fibres</p>	<p>Specification #2350 2000 M Reels</p> <p>Specification #2350 2000 M Reels</p>
<p>Fibre Optic Cable Single Mode, Outdoor Non-Armoured Fig-8</p> 	<p>2-93-00 5000205</p> <p>2-93-10 5000206</p>	<p>48 Fibres</p> <p>96 Fibres</p>	<p>Specification #1350 2000 M Reels</p> <p>Specification #1350 2000 M Reels</p>

DESCRIPTION OF ITEM	DEPT. CODE NUMBER	SIZE	ORDERING INFORMATION
<p>Fibre Optic Cable Multi Mode Outdoor Drop</p> 	<p>2-94-00 500207</p> <p>2-94-10 5018355</p>	<p>6 Fibres Loose Tube</p> <p>6 Fibres Tight Buffered</p>	<p>Specification #9106</p>
<p>Fibre Optic Cable Hybrid Indoor/Outdoor</p> 	<p>2-95-00 5001494</p>	<p>48MMF/48SMF</p>	<p>Specification #9106</p>



DESCRIPTION OF ITEM	DEPT. CODE NUMBER	SIZE / WEIGHT	ORDERING INFORMATION
Wood Pole 	3-07-35 5000208 3-07-40 5000209 3-07-45 5000210 3-07-50 5000211	35 Feet Approx. 750 lbs 40 Feet Approx. 970 lbs 45 Feet Approx. 1145 lbs 50 Feet Approx. 1365 lbs	As per Specs
Wood Pole 	3-07-55 5000212 3-07-60 5000213 3-07-65 5000214 3-07-70 5000215	55 Feet Approx. 1540 lbs 60 Feet Approx. 1935 lbs 65 Feet Approx. 2200 lbs 70 Feet Approx. 2640 lbs	As per Specs
Steel Pole - Distribution, Tapered, Buck Arm	3-08-55 5001331 3-08-60 5000216	55 Feet Approx. 3280 lbs 60 Feet	Dwg Ts-193A, Ms-425 Specification 1520, 5350 Dwg Ts-229 Plus General Specifications

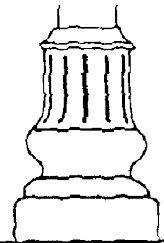

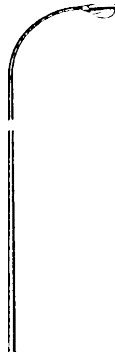
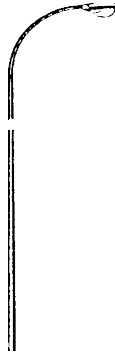
DESCRIPTION OF ITEM	DEPT. CODE NUMBER	SIZE / WEIGHT	ORDERING INFORMATION
Steel Pole - Support	3-09-40 5000217	40 Feet	Dwg #MS419 Specification 1524
Fibreglass Distribution Pole	3-10-40 5000218	40 Feet	Shakespeare

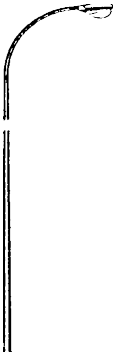
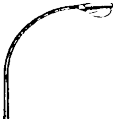
DESCRIPTION OF ITEM	DEPT. CODE NUMBER	SIZE / WEIGHT	ORDERING INFORMATION
Precast Concrete Base for Steel Streetlight Pole Multiport Up to 25 Foot Single Davit Up to 35 Foot Single Davit Up to 35 Foot Double Davit Up to 40 Foot Single Davit Up to 60 Foot 18 Meter and Highway	4-01-25 5000219 4-01-35 5000220 4-01-40 5000221 4-01-60 5000222	<u>Bolt Spacing</u> 7 1/16" (179 mm) O.C. Approx. 1000 lbs 8 1/8" (206 mm) O.C. Approx. 1500 lbs 9 3/16" (233 mm) O.C. Approx. 1900 lbs 10" (254 mm) O.C. Approx. 2300 lbs	Dwg. L2s-176 Dwg. L2s-124 Dwg. L2s-130 Dwg. L2s-173
Decorative Base Includes Two Interchangeable Halves 	4-02-10 5000223 4-02-20 5000224 4-02-30 5000225	Broadway - 30" Octagon Spadina Promenade - 36" (For Shaft 4-15-21) Octagon Brighton (For Shaft 4-15-70) Round	Dwg. L2s - 135 Dwg. L2s - 162
Steel Anchor Base for Steel Street Light Pole 18' Pathway 25' & 30' Single Overbraced 30' & 35' Single Davit 35' Single Overbraced 30' Double Overbraced 35' Double Davit 50' Two Fixtures	4-03-18 5001332 4-03-30 5001333 4-03-35 5001334 4-03-50 5001335	6 3/8" to 8 1/2" OC (162mm to 216mm) 48" Long, 6.63" Dia 6 3/8" to 9 7/8" OC (162mm to 252mm) 84" Long, 6.63" Dia 7 3/4" to 12" OC (198mm to 305mm) 84" Long, 8.6" Dia 9 7/8" to 11 5/8" OC (252mm to 296mm) 120" Long, 10.75" Dia	HUB SA1122305 RED LEAF 04-06-12 MACP D06048BBB08118V HUB T1121051 RED LEAF 7612 MACP D06084BBB08148V HUB C11242QG4VP RED LEAF 7-08-14 MACP D08084BBB11178V HUB T1121083 RED LEAF 10-10-16 MACP D10120BBB11170V

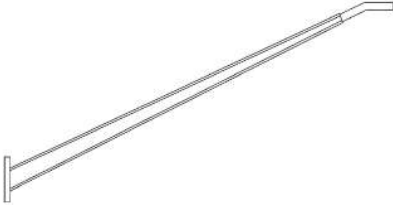

DESCRIPTION OF ITEM	DEPT. CODE NUMBER	SIZE / WEIGHT	ORDERING INFORMATION
<p>Steel Streetlight Pole For Single or Double Davit Arm</p> 	<p>4-10-20 5000226</p> <p>4-10-24 5000227</p> <p>4-10-25 5000228</p>	<p>Shaft - 11 ft. long 20 ft. (6m) fxt height Galvanized</p> <p>Shaft - 15 ft. long 24 ft. (7m) fxt height Green</p> <p>Shaft - 15 ft. long 24 ft. (7m) fxt height Galvanized</p>	<p>Specification 5200, 5350 Dwg L2s-191</p> <p>Specification 5200, 5350, 5365, 5390 Dwg L2s-184</p> <p>Specification 5200, 5350 Dwg L2s-184</p>
<p>Steel Streetlight Pole For Single or Double Davit Arm</p> 	<p>4-10-30 5000229</p> <p>4-10-31 5000230</p> <p>4-10-32 5000231</p> <p>4-10-33 5001336</p>	<p>Shaft 30 ft (9m) fxt. height 7 5/8" to 9 1/4" Blt Sp 19.7' (6m) long</p> <p>Green</p> <p>Black</p> <p>Grey</p> <p>Galvanized</p>	<p>Specification 5200, 5350, 5365, 5390 Dwg L2s-138</p> <p>Dwg L2s-197</p> <p>Specification 5350</p>
<p>Steel Streetlight Pole For Single or Double Davit Arm</p> 	<p>4-10-35 5000232</p> <p>4-10-36 5000233</p> <p>4-10-37 5000234</p> <p>4-10-38 5000235</p> <p>4-10-39 5000236</p>	<p>Shaft 35 ft (11m) fxt. height 7 5/8" to 9 7/8" Blt Sp 26.2' (8m) long</p> <p>Green</p> <p>Black</p> <p>Red</p> <p>Grey</p> <p>Galvanized</p>	<p>Specification 5200, 5350, 5365, 5390 Dwg L2s-139</p> <p>Dwg L2s-198</p> <p>Specification 5350</p>

DESCRIPTION OF ITEM	DEPT. CODE NUMBER	SIZE / WEIGHT	ORDERING INFORMATION
<p>Steel Streetlight Pole For Single or Double Davit Arm</p> 	<p>4-10-43 5000237</p>	<p>Shaft 40 ft (12m) fxt. ht 7 1/2" to 9 1/4" Blt Sp 30.2' (9.2m) long</p> <p>Galvanized</p>	<p>Specification 5200 5350 Dwg L2s-174</p> <p>Specification 5350</p>
<p>Steel Streetlight Pole For Single or Double Davit Arm</p> 	<p>4-10-60 5000238</p>	<p>Shaft 59 ft (18m) fxt. ht 9 3/4" to 10 1/4" Blt Sp 49.2' (15m) long</p> <p>Galvanized</p>	<p>Specification 5200 Dwg L2s-155</p> <p>Specification 5350</p>
<p>Steel Streetlight Arm Single Davit</p> 	<p>4-10-70 5000239</p> <p>4-10-71 5000240</p> <p>4-10-73 5000241</p>	<p>Arm 8 ft (2.5m) overhang</p> <p>Green</p> <p>Black</p> <p>Galvanized</p>	<p>Specification 5200, 5350, 5365, 5390 Dwg L2s-137</p> <p>Specification 5350</p>

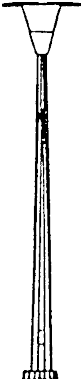

DESCRIPTION OF ITEM	DEPT. CODE NUMBER	SIZE / WEIGHT	ORDERING INFORMATION
<p>Steel Streetlight Arm Single Davit</p> 	<p>4-10-75 5000242</p> <p>4-10-79 5000243</p>	<p>Arm 10 ft (3m) overhang</p> <p>Green</p> <p>Galvanized</p>	<p>Specification 5200, 5350, 5365, 5390 Dwg L2s-136</p> <p>Specification 5350</p>
<p>Steel Streetlight Arm Double Davit</p> 	<p>4-10-80 5000244</p> <p>4-10-81 5000245</p> <p>4-10-83 5000246</p> <p>4-10-85 5000247</p>	<p>Arm 10 ft (3m) overhang</p> <p>Green</p> <p>Black</p> <p>Galvanized</p> <p>Arm 15 ft (3m) overhang</p> <p>Galvanized</p>	<p>Specification 5200, 5350, 5365, 5390 Dwg L2s-227</p> <p>Specification 5200, 5350</p> <p>Dwg L2s-234</p>
<p>Steel Streetlight Arm</p> <p>For Use in Evergreen</p>	<p>4-10-90 5000248</p>	<p>Galvanized</p>	<p>Specification 5200 Dwg L2s-199</p>

DESCRIPTION OF ITEM	DEPT. CODE NUMBER	SIZE / WEIGHT	ORDERING INFORMATION
<p>Steel Streetlight Pole For Single or Double Overhead Wired Arm</p> 	<p>4-11-25 5000249</p> <p>4-11-30 5000250</p> <p>4-11-35 5000251</p>	<p>Galvanized</p> <p>Shaft 25 ft (7.6m) fxt. ht. 7" to 7 3/4" Blt Sp 25' (7.8m) long</p> <p>Shaft 30 ft (9m) fxt. ht. 7 1/2" to 8 1/4" Blt Sp 30' (9.1m) long</p> <p>Shaft 35 ft (11m) fxt. ht. 7 1/2" to 9 1/4" Blt Sp 35' (10.7m) long</p>	<p>Specification 5200, 5350 Dwg L2s-220-01</p> <p>Dwg L2s-220-02</p> <p>Dwg L2s-220-03</p>
<p>Steel Streetlight Arm Overhead Wired NOT FOR WOOD POLES</p>  <p>Old Style</p> 	<p>4-11-75 5000252</p> <p>4-11-85 5000253</p>	<p>Galvanized</p> <p>Arm 10 ft (3m) overhang</p> <p>Arm 15 ft (4.5m) overhang</p>	<p>Specification 5200, 5350 Dwg L2s-220-04</p> <p>Dwg L2s-220-05</p>
<p>Steel Streetlight Pole For Double Elliptical Arm</p>	<p>4-13-37 5000254</p>	<p>Shaft 34 ft (10.4m) fxt. ht. 8 1/2" to 9 1/2" Blt Sp 27.3' (8.3m) long</p> <p>Red</p>	<p>Specification 5200, 5350, 5365, 5390 Dwg L2s-149-01</p>

DESCRIPTION OF ITEM	DEPT. CODE NUMBER	SIZE / WEIGHT	ORDERING INFORMATION
Steel Streetlight Arm Double Elliptical	4-13-76 5000255 4-13-77 5000256	Arm 10 ft (3m) overhang Black Red	Specification 5200, 5350, 5365, 5390 Dwg L2s-149-02
Steet Streetlight Pole For Vector or Mongoose Lighting Bottom Section Top Section	4-14-25 5000257 4-14-50 5000258	Galvanized 7.874 m 25' 10" 7.38 m 25' 8" 50' (15.24m Pole)	Specification 5200, 5350 Dwg L2s-160
Steel Streetlight Pole For PTL, Washington, Marine & Shoebox Fixtures 	4-15-11 5000259 4-15-12 5000260 4-15-13 5000261	<u>Bolt Spacing</u> 6 3/4" to 8 1/8" 12 ft (3.66m) Base 6" Black Red Brown	Specification 5200, 5350, 5365, 5390 Dwg. L2s-148

DESCRIPTION OF ITEM	DEPT. CODE NUMBER	SIZE / WEIGHT	ORDERING INFORMATION
<p>Steel Streetlight Pole For Washington Fixture Only</p> 	<p>4-15-21 5000262</p>	<p><u>Bolt Spacing</u> 6 3/4" to 8 1/8" 12 ft (3.66m) Base 4.75"</p> <p>Black For Ornamental Base</p>	<p>Specification 5200, 5350, 5365, 5390 Dwg. L2s-169</p>
<p>Steel Streetlight Pole For PTL & Marine Fixture</p> 	<p>4-15-30 5000263</p> <p>4-15-31 5000264</p> <p>4-15-33 5000265</p> <p>4-15-35 5000266</p>	<p><u>Bolt Spacing</u> 6 3/4" to 8 1/8" 18 ft (5m)</p> <p>Green</p> <p>Black</p> <p>Brown</p> <p>Grey</p>	<p>Specification 5200, 5350, 5365, 5390 Dwg. L2s-165</p>
<p>Steel Streetlight Pole</p> <p>For Use in Evergreen</p>	<p>4-15-50 5000267</p>	<p><u>Bolt Spacing</u> 6 3/4" to 8 1/8" 18 ft (5m)</p> <p>Galvanized</p>	<p>Specification 5200 & 5350 Dwg L2s-200</p>

DESCRIPTION OF ITEM	DEPT. CODE NUMBER	SIZE / WEIGHT	ORDERING INFORMATION
Steel Streetlight Pole Brighton Subdivision	4-15-70 5000268	Black	Specification 5200, 5350, 5365, 5390 Dwg L2s-239
Steel Streetlight Arm Brighton Subdivision	4-15-80 5000269	Black	Specification 5200, 5350, 5365, 5390 Dwg L2s-237
Steel Streetlight Pole For Invue Fixture	4-16-10 5000270 4-16-12 5000271 4-16-16 5000272 4-16-23 5000273	Graphite Metallic 10 Foot 12 Foot 16 Foot 23 Foot	Specification 5200, 5350, 5365, 5390 Dwg L2s-185-02 Dwg L2s-185-01 Dwg L2s-185-03 & Dwg L2s-185-04 Dwg L2s-185-05

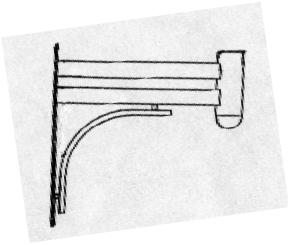

DESCRIPTION OF ITEM	DEPT. CODE NUMBER	SIZE / WEIGHT	ORDERING INFORMATION
<p>Steel Streeilight Arm For Invue Fixture</p> <p>Flite Style</p>  <p>Slide Style</p> 	<p>4-16-30 5000274</p> <p>4-16-32 5000275</p> <p>4-16-34 5000276</p>	<p>Graphite Metallic</p> <p>Arm Flite Style</p> <p>Arm Slide Style</p> <p>Arm Slide Style 250 Watt Only</p>	<p>CP FLS-ARM-GM</p> <p>CP SLS-ARM-GM</p> <p>CP SDM1-ARM-GM</p>
<p>Invue Decorative Base</p>	<p>4-16-50 5000277</p> <p>4-16-51 5000278</p>	<p>4" Hole</p> <p>5" Hole</p>	<p>CP 1000D49H01GM</p>
<p>Invue 18" Pole Extension & Cap</p>	<p>4-16-52 5000279</p>	<p>Graphite Metallic</p> <p>For use with 4-16-30 @ 12'Mounting height</p>	<p>Dwg L2s-185-01</p>

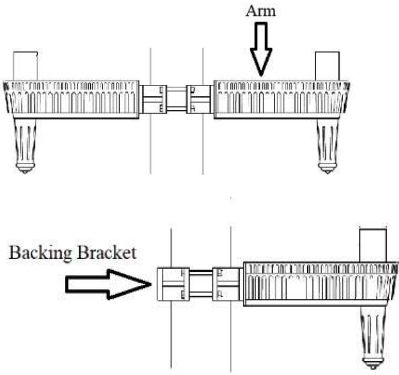
DESCRIPTION OF ITEM	DEPT. CODE NUMBER	SIZE / WEIGHT	ORDERING INFORMATION
<p>Icon Style Streetlighting</p> <p>Pole</p> <p>Arm</p>	<p>4-17-16 5000280</p> <p>4-17-30 5000281</p>	<p>16' Stone Grey</p> <p>Upsweep</p>	<p>Specification 5174 Dwg L2s-215</p> <p>CP VA1006 Specification 5174 Dwg L2s-215</p>
<p>Streetlight Elliptical Arm FOR WOOD POLES</p> 	<p>4-20-02 5000282</p> <p>4-20-06 5000283</p> <p>4-20-10 5000284</p> <p>4-20-12 5000285</p> <p>4-20-18 5000286</p>	<p>1 1/2" x 2'</p> <p>2" x 6'</p> <p>2" x 10'</p> <p>2" x 12'</p> <p>2" x 18'</p>	<p>Specification 5200, 5350 Dwg L2s-196-01</p> <p>Dwg L2s-196-02</p> <p>Dwg L2s-196-03</p> <p>Dwg L2s-196-04</p> <p>Dwg L2s-161-01&02</p>
<p>Streetlight Arm For Marine Fixtures</p> 	<p>4-21-30 5000287</p> <p>4-21-31 5000288</p> <p>4-21-32 5000289</p> <p>4-21-33 5000290</p>	<p>30"</p> <p>Green</p> <p>Red</p> <p>Blue</p> <p>Black</p>	<p>Specification 5390 Dwg L2s-154 Colour as per Application</p>

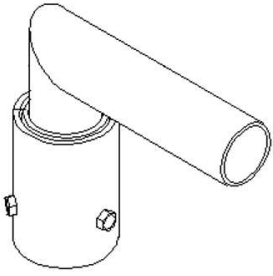
DESCRIPTION OF ITEM	DEPT. CODE NUMBER	SIZE / WEIGHT	ORDERING INFORMATION
<p>Streetlight Arm For Marine Pendant Fixture</p> 	<p>4-22-30 5000291</p>	<p>Black</p>	<p>Specification 5390 Dwg L2s-188</p>
<p>Streetlight Arm Steel</p> <p>For use on 3rd Avenue</p> <p>For use in Kensington</p> <p>LED Floodlight Arm Attachment to wood pole</p>	<p>4-22-40 5000292</p> <p>4-22-50 5000293</p> <p>4-23-15 5000294</p>	<p>6' Straight Graphite Metallic</p> <p>Decorative Black</p>	<p>Specification 5200, 5350, 5390 Dwg Ls-417-04</p> <p>Dwg L2s-230</p> <p>Dwg L2s-228</p>
<p>Streetlight Arm & Bracket For Washington Fixtures</p> 	<p>4-23-30 5000295</p> <p>4-23-31 5000296</p>	<p>Black</p>	<p>HCI A316-1A-CM-6- RAL9011-BLACK</p> <p>HCI CLAMP-6- RAL9011-BLACK</p>

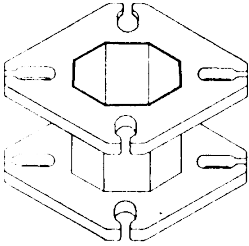
DESCRIPTION OF ITEM	DEPT. CODE NUMBER	SIZE / WEIGHT	ORDERING INFORMATION
<p>Streetlight Arms</p> <p>For Washington Fixtures on Wood Poles</p> <p>For Floodlights - Double Bullhorn</p> <p>For Offset Lighting - Double Bullhorn Mongoose/Vector</p> <p>For Offset Lighting - Triple Bullhorn Mongoose/Vector</p>	<p>4-23-40 5000297</p> <p>4-24-10 5000298</p> <p>4-24-20 5000299</p> <p>4-24-21 5000300</p>	<p>Black</p> <p>Green</p> <p>Galvanized</p> <p>Galvanized</p>	<p>Dwg L2s-168</p> <p>Dwg L2s-186-02</p> <p>Dwg L2s-186-01</p> <p>Dwg L2s-186-03</p>
<p>Arm Shoebox LED - Brown</p> 	<p>4-25-05 5000301</p>	<p>Sepia Brown</p>	<p>Dwg L2s-226-02</p>
<p>Steel Extensions For Combination Traffic and Streetlight Poles</p> <p>Black - For use in Kensington</p>	<p>4-26-04 5000302</p> <p>4-26-06 5000303</p> <p>4-26-12 5000305</p> <p>4-26-13 5000306</p>	<p>Graphite Metallic Extension 4' Octagonal Pole</p> <p>Galvanized Extension 6' Octagonal Pole</p> <p>Extension 12' Octagonal Pole</p> <p>Extension 13' Octagonal Pole</p>	<p>Dwg L2s-193</p> <p>Dwg L2s-170</p> <p>Dwg L2s-179</p> <p>Dwg L2s-229</p>

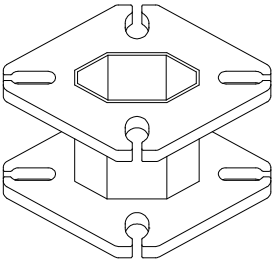
DESCRIPTION OF ITEM	DEPT. CODE NUMBER	SIZE / WEIGHT	ORDERING INFORMATION
Steel Pole Tenon Adapter For Washington, Marine & PTL Fixtures	4-27-01 5000307	Small Round (4") Sepia Brown (RAL8014)	Dwg L2s-158-01
	4-27-04 5000308	Octagonal (4 5/8") Black	Dwg L2s-147
	4-27-05 5000309	Small Round (5") Black	Dwg L2s-158-01
	4-27-06 5000310	Medium Round (6") Black	Dwg L2s-158-01
	4-27-07 5000311	Large Round (7") Blue	Dwg L2s-158-01
	4-27-09 5000312	Large Round (9") Blue	Dwg L2s-158-01
Steel Pole Tenon Adapter For Mongoose Fixture	4-27-20 5000313		Dwg L2s-158-02
Base Plate Adapter for Steel Pole  (Electronic Shop also use these)	4-28-07 5000314 4-28-12 5000315	Galvanized 1" Dia. Bolt <u>Bolt Spacing</u> 6 3/4" to 8 1/8" Height 7" 1" Dia. Bolt <u>Bolt Spacing</u> 6 3/4" to 8 1/8" Height 12"	POLE Dwg L2s-133 POLE Dwg L2s-133

DESCRIPTION OF ITEM	DEPT. CODE NUMBER	SIZE / WEIGHT	ORDERING INFORMATION
<p>Steel Streetlight Pole Extension</p> 	<p>4-29-12 5000316</p>	<p>Galvanized Bolt Spacing 7 11/16" to 10" Height 12"</p>	<p>Dwg L2s-195</p>
<p>Reaction Plates - Breakaway Base Small</p> <p>Medium & Large</p> 	<p>4-33-35 5000317</p> <p>4-33-50 5000318</p>	<p>Use on New Installs With 4-36-35 With 4-36-40 & 4-36-50</p>	<p>Dwg L2S-232-04</p> <p>Dwg L2S-232-05</p>
<p>Couplers - Breakaway Base For Repairs</p> <p>35 Foot Single Davit</p> <p>35 Foot Double Davit 40 Foot Single Davit 50 Foot Highway</p>	<p>4-36-35 5000319</p> <p>4-36-40 5000320</p>	<p>1" Dia. Bolt Round</p> <p>1 1/4" Dia. Bolt Round</p>	<p>SB C-5</p> <p>SB C-7</p>



DESCRIPTION OF ITEM	DEPT. CODE NUMBER	SIZE / WEIGHT	ORDERING INFORMATION
<p>Shroud - Breakaway Base</p> <p>35 Foot Single Davit</p> <p>35 Foot Double Davit 40 Foot Single Davit</p> <p>50 Foot Vector Lighting</p> 	<p>4-37-35 5000321</p> <p>4-37-40 5000322</p> <p>4-37-50 5000323</p>	<p>Stainless Steel</p> <p>For 8 1/8" On Square</p> <p>For 9 3/16" On Square</p> <p>For 10 1/4" On Square</p>	<p>Dwg L2S-232-01 SB S-3C</p> <p>Dwg L2S-232-02 SB S-5C</p> <p>Dwg L2S-232-03 SB S-8C</p>
<p>Hand Hole Assembly</p> 	<p>4-38-01 5000324</p> <p>4-38-21 5000325</p> <p>4-38-30 5000326</p> <p>4-38-40 5000327</p>	<p>Bolt to be cadmium</p> <p>6" - Primed</p> <p>12" - Galvanized</p> <p>12" Rectangle- Primed</p> <p>12" For 4" Round Pole Graphite Metalic</p>	<p>CIM</p> <p>Dwg L2s 194-01</p> <p>Dwg L2s 194-02</p> <p>Dwg L2s 194-03</p> <p>Dwg L2s 194-04</p>
<p>Backer Bar for Handhole</p>  <p>Tamper Proof Bolts</p>	<p>4-38-50 5000328</p> <p>4-39-01 5000329</p>	<p>14" x 1.5" x .25" c/w Threaded Insert</p> <p>3/8" x 4" SS</p>	<p>BRYCE 3GMRR37400</p>

DESCRIPTION OF ITEM	DEPT. CODE NUMBER	SIZE / WEIGHT	ORDERING INFORMATION
<p>Cable Retainer</p> 	<p>4-40-10 5000331</p>	<p>6" Foundation Anchor</p>	<p>PELCO SP-6200-GLV</p>
<p>Cobra Head Fixture - LED Local Roadway</p> 	<p>4-51-05 5000332</p>	<p>34 Watt 120/277 Volt w receptacle</p>	<p>Leotek GCJ1-20H-MV-WW- 2R-GY-530-PCR7</p>
<p>Cobra Head Fixture - LED Collector Roadway</p> 	<p>4-51-10 5000333</p>	<p>47 Watt 120-277 Volt w receptacle</p>	<p>GE Current ERL1006B330- AXXXXILR</p>

DESCRIPTION OF ITEM	DEPT. CODE NUMBER	SIZE / WEIGHT	ORDERING INFORMATION
<p>Cobra Head Fixture - LED Arterial Roadway</p> 	<p>4-51-15 5000334</p> <p>4-51-18 5000335</p> <p>4-51-20 5000336</p>	<p>64 Watt 120-277 Volt w receptacle</p> <p>64 Watt 347 Volt w receptacle</p> <p>120-277 Volt w receptacle</p> <p>LED Roadway (115W) L6-060M-5-7-2ES-W-S-GY-3-UL-2-S-A-0628</p> <p>Leotek (123 W) GCM3-60J-MV-30K-2R-GY-170-PCR7-SP2-WL</p> <p>ACUITY (130W) ATB2-60BLEDE70-MVOLT-R2-3K-P7-RAL7035-RFD312465</p>	<p>Leotek GCJ3-30J-MV-30K-2R-GY-90-PCR7-WL</p> <p>Leotek GCJ3-30J-HV-30K-2R-GY-075-PCR7-WL</p> <p>LED Roadway (115W) L6-060M-5-7-2ES-W-S-GY-3-UL-2-S-A-0628</p> <p>Leotek (123 W) GCM3-60J-MV-30K-2R-GY-170-PCR7-SP2-WL</p> <p>ACUITY (130W) ATB2-60BLEDE70-MVOLT-R2-3K-P7-RAL7035-RFD312465</p>
<p>Mongoose Fixture - LED Low Angle</p> 	<p>4-56-41 5000337</p> <p>4-56-42 5000338</p> <p>4-56-62 5000339</p> <p>4-56-91 5000340</p>	<p>4COB/168W 120/240 V</p> <p>4COB/168W 347/600 V</p> <p>6COB/245W 347/600 V</p> <p>9COB/367W 120/240 V</p>	<p>HOL MGLED-43KASWLVGNL</p> <p>HOL MGLED-43KAHWLVGNL</p> <p>HOL MGLED-63KAHWLVGNL</p> <p>HOL MGLED-93KASWLVGNL</p>
<p>Mongoose Fixture - LED High Angle</p> 	<p>4-56-92 5000341</p> <p>4-56-93 5000342</p>	<p>9COB/367W 347/600 V</p> <p>9COB/367W 120/240 V</p>	<p>HOL MGLED-93KAHWLVGNL</p> <p>HOL MGLED-93KASWHVGNL</p>





DESCRIPTION OF ITEM	DEPT. CODE NUMBER	SIZE / WEIGHT	ORDERING INFORMATION
<p>Highway Fixture - LED</p> 	<p>4-57-51 5000343</p> <p>4-57-52 5000344</p> <p>4-57-54 5000345</p>	<p>120/240 V RSX2-P3/147W</p> <p>5 Square/162W</p> <p>347/600 V RSX2-P3/147W</p> <p>5 Square/162W</p> <p>120/240 V Horizontal Tenon RSX2-P3/147W</p>	<p>LITH RSX2 LED P3 30K R3 MVOLT IS PER7 DNAXD CP GAN-AF-05-LED- U-T2R-AP-ADJS- 8030-600-4N7-TH</p> <p>LITH RSX2 LED P3 30K R3 HVOLT IS PER7 DNAXD CP GAN-AF-05-LED- 9-T2R-AP-ADJS- 8030-600-4N7-TH</p> <p>LITH RSX2 LED P3 30K R3 MVOLT MA PER7 DNAXD</p>
<p>Highway Fixture - LED</p> 	<p>4-57-81 5000346</p> <p>4-57-82 5000347</p>	<p>5 Square/162W</p> <p>120/240 V RSX3-P3/266W</p> <p>8 Square/257W</p> <p>347/600 V RSX3-P3/266W</p> <p>8 Square/257W</p>	<p>CP GAN-AF-05-LED- U-T2R-AP-MA- 8030-600-4N7-TH</p> <p>LITH RSX3 LED P3 30K R3 MVOLT IS PER7 DNAXD CP GAN-AF-08-LED- U-T2R-AP-ADJS- 8030-600-4N7-TH</p> <p>LITH RSX3 LED P3 30K R3 HVOLT IS PER7 DNAXD CP GAN-AF-08-LED- 9-T2R-AP-ADJS- 8030-600-4N7-TH</p>
<p>Galleon Fixture - LED</p> 	<p>4-57-91 5000348</p> <p>4-57-92 5000349</p>	<p>10 Square/323W 120/240 V</p> <p>10 Square/323W 347/600 V</p>	<p>CP GAN-AF-10-LED- U-T2R-AP-ADJS- 8030-600-4N7-TH</p> <p>CP GAN-AF-10-LED- 9-T2R-AP-ADJS- 8030-600-4N7-TH</p>

DESCRIPTION OF ITEM	DEPT. CODE NUMBER	SIZE / WEIGHT	ORDERING INFORMATION
<p>Washington Fixture</p> 	<p>4-60-05 5000350</p> <p>4-60-25 5000351</p>	<p>Black</p> <p>35 Watt LED 120/240 Volt</p> <p>120 Watt LED 120/240 Volt</p>	<p>STERN PT-A850SRLE D5P-2ARC27T3R- MDL03-A-BK No Substitutes</p> <p>STERN PT-A850S RLED-5P-24L27T4- MDL018-A-BK No Substitutes</p>
<p>Fixtures - For use on 2nd Ave</p> <p>Pathway Fixture LED</p>  <p>Roadway Fixture LED</p>	<p>Charcoal Grey</p> <p>4-61-05 5000352</p> <p>4-61-10 5000353</p>	<p>20 Watt 120/277 Volt</p> <p>100 Watt 120/277 Volt</p>	<p>CYCLONE CLE17T4C-FGC-4- 20W-3K-240-R30- RAL7026-TX</p> <p>CYCLONE CLE17T4C-FGC-4- 100W-3K-240-R30- RAL7026-TX</p>
<p>Euro Series Fixture</p> 	<p>4-62-03 5000354</p>	<p>For Central Avenue</p> <p>31 Watt LED</p>	<p>STERN E250LEDFLD/ PT/1RND35T5-ML/ BKT</p>

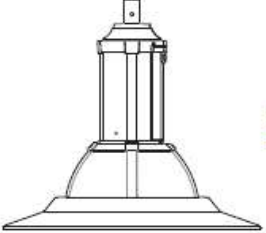

DESCRIPTION OF ITEM	DEPT. CODE NUMBER	SIZE / WEIGHT	ORDERING INFORMATION
<p>Villa Maria Fixture</p> 	<p>4-63-05 5020814</p> <p>4-63-10 5020805</p>	<p>23 Watt LED 120/240 Volt</p> <p>112 Watt LED 120/240 Volt</p>	<p>CYCLONE VMAT4A-NL-T1-P10-30K-MVOLT-10KV-R30-BK-TX</p> <p>CYCLONE VMAT4A-NL-T3M-P70-30K-MVOLT-10KV-R30-BK-TX</p>
<p>Marine Fixture LED</p> 	<p>4-65-01 5000355</p> <p>4-65-02 5000356</p>	<p>35 Watt 120/277 Volt 23" Brim Blue</p> <p>35 Watt 120/277 Volt 23" Brim Black Currant</p>	<p>HCI SF130-S-CPC-LED35W-3000K-120-277V-TYPEIII-DIM-RAL5015</p> <p>HCI SF130-S-CPC-LED35W-3000K-120-277V-TYPEIII-DIM-RAL3005</p>
<p>Marine Fixture LED</p> 	<p>4-65-07 5000357</p> <p>4-65-08 5000358</p>	<p>35 Watt 120/277 Volt 23" Brim Green</p> <p>35 Watt 120/277 Volt 23" Brim Red</p>	<p>HCI SF130-S-CPC-LED35W-3000K-120-277V-TYPEIII-DIM-RAL6029</p> <p>HCI SF130-S-CPC-LED35W-3000K-120-277V-TYPEIII-DIM-RAL3002</p>

DESCRIPTION OF ITEM	DEPT. CODE NUMBER	SIZE / WEIGHT	ORDERING INFORMATION
<p>Marine Fixture LED</p> 	<p>4-65-10 5000359</p> <p>4-65-11 5000360</p>	<p>55 Watt 120/277 Volt 23" Brim Green</p> <p>35 Watt 120/277 Volt 23" Brim Black</p>	<p>HCI SF130-S-CPC- LED55W-3000K- 120-277V-TYPEIII- DIM-RAL6029</p> <p>HCI SF130-S-CPC- LED35W-3000K- 120-277V-TYPEIII- DIM-RAL9017</p>
<p>Marine Fixture HPS</p> 	<p>4-65-27 5000361</p>	<p>250 Watt 120/240 Volt 32" Brim Blue</p>	<p>SDL SLF985-RD3- 250S-120/240-CC Specification 5150, 5390 Dwg L2s-153</p>
<p>Pendant Marine Fixture - LED</p> 	<p>4-66-10 5001337</p> <p>4-66-25 5001338</p>	<p>Black</p> <p>54 Watt LED 120/277 Volt</p> <p>100 Watt LED 120/277 Volt</p>	<p>HCI F172-L-MOD- 54WLED-120-277V- IES3-HSS-RAL9011</p> <p>HCI F172-L-MOD- 100WLED-120-277V- IES3-HSS-RAL9011</p>



DESCRIPTION OF ITEM	DEPT. CODE NUMBER	SIZE / WEIGHT	ORDERING INFORMATION
LED Retro Fit Kit for Marine Fixture	4-66-30 5017828 4-66-35 5017839	54 Watt LED 120/277 Volt 100 Watt LED 120/277 Volt	HCI RETRO-FIT-LED-F172-L-MOD-54WLED-120-277V-IES3 HCI RETRO-FIT-LED-F172-L-MOD-100WLED-120-277V-IES3
Fixtures & Poles - For use on 3rd Avenue Pedestrian Pole & Fixture Historical Pendant Fixture	4-67-05 5000362 4-67-25 5000363	Graphite Metallic 12' & 50 Watt MH 120 Watt LED 347 Volt	Specification 5111 Dwg L2s-218 HCI F302-MOD-CTG-120W-LED-347V-IES3-3000K-FINIAL-MOD-CUSTOM-COLOR
Fixtures - For use in Kensington Historical Pendant Fixture LED Collector Roadway 	4-68-10 5000365	Black 120 Watt 120-277 Volt 4000K	HCI F302-MOD-L-LTG-120W-LED-3000K-120-277V-IES3-MOD-FINIAL-RAL9017



DESCRIPTION OF ITEM	DEPT. CODE NUMBER	SIZE / WEIGHT	ORDERING INFORMATION
Fixture Brighton Pendant LED 	4-69-05 5000366	Black 140 Watt 120/277 Volt	CYCLONE CO12P1B-FGC-4-140W-3K-240-R30-RAL7026-TX
Pathway Fixture 	4-71-05 5000368	15 Watt 120/277 V, 3000K with receptacle RAL8014-Sepia Brown	Leotek GCJ0-15H-MV-WW-2R-CC-300-PCR7
Wallpack Fixture  	4-72-07 5000369 4-72-08 5000370 4-72-10 5000371 4-72-11 5000372	30 Watt LED 120/277 Volt Fail Safe 30 Watt LED 347 Volt Fail Safe Bronze 28/40/60W Selectable 120-347V, 3000K/4000K/5000K Selectable 40 Watt LED 347 Volt, 3000K5 w/o receptacle	CP G12-LD4-30W-30-CL-UNV-EDC1-CSTG/BZ CP G12-LD4-30W-30-CL-347V-EDC1-CSTG/BZ ABOVE ALL SCWP-SPS-SW8

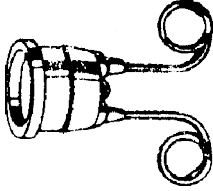
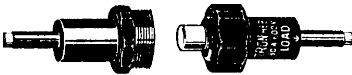

DESCRIPTION OF ITEM	DEPT. CODE NUMBER	SIZE / WEIGHT	ORDERING INFORMATION
<p>Floodlight Fixture - LED</p> <p>Traffic Bridge Pedestrian</p> 	<p>4-73-00 5000373</p> <p>4-73-25 5000374</p> <p>4-73-26 5000375</p>	<p>Bronze</p> <p>25 Watt LED</p> <p>Order Slipfit knuckle</p> <p>129 Watt LED</p> <p>120/277 Volt, 3000K</p> <p>Top & Side Visor</p>	<p>HUB FSL-10L-25-3K-RM-U-K-DB S-302-M51</p> <p>CP NFFLD-C40-E-UNV-66-S-CB-7030</p> <p>No alternates</p> <p>CP TS2/NFFLD-CB</p>
<p>Invue Fixture - LED</p>  	<p>4-76-05 5000377</p> <p>4-76-10 5000378</p> <p>4-76-25 5000379</p>	<p>Graphite Metallic</p> <p>25 Watt LED</p> <p>50 Watt LED</p> <p>125 Watt LED</p>	<p>CP ICS-E01-LED-E1-T3-GM-LCF</p> <p>CP ICS-E02-LED-E1-T3-GM-LCF</p> <p>CP ICM-E05-LED-E1-T3-GM-LCF</p>
<p>Icon Fixture - LED</p> 	<p>4-77-10 5000380</p>	<p>Stone Grey</p> <p>50 Watt LED</p>	<p>CP ICS-E02-LED-E1-T3-RAL7030-LCF (VA1006-xx)</p> <p>Specification 5174</p> <p>Dwg Ls-215</p>

DESCRIPTION OF ITEM	DEPT. CODE NUMBER	SIZE / WEIGHT	ORDERING INFORMATION
<p>LED Fixture - For Use In Evergreen</p> <p>Pathway</p> <p>Roadway</p> <p>Roadway (Wide)</p> 	<p>4-78-05 5000381</p> <p>4-78-10 5000382</p> <p>4-78-15 5000383</p>	<p>22 Watt LED w/o Receptacle</p> <p>55 Watt LED w/o Receptacle</p> <p>107 Watt LED 120/240 Volt w/o Receptacle</p>	<p>LED SAT-24S-280mA-T2</p> <p>LED SAT-48S-0-S-T2-350- GY-1-A-NS-XX</p> <p>LED SAT-72M-450mA-T3</p>
<p>High Pressure Sodium Vapor Lamp Mogul Base, 30,000 Hour Non-cycling</p> 	<p>4-80-05 5000384</p> <p>4-80-07 5001339</p> <p>4-80-10 5001340</p> <p>4-80-15 5001341</p>	<p>30,000 Hour Non-cycling 50 Watt</p> <p>70 Watt</p> <p>100 Watt</p> <p>150 Watt</p>	<p>SYL LU50/Plus/Eco</p> <p>SYL LU70/Plus/Eco GE LU70/Eco/NC</p> <p>SYL LU100/Plus/Eco GE LU100/Eco/NC</p> <p>SYL LU150/Plus/Eco GE LU150/Eco/NC</p>
<p>High Pressure Sodium Vapor Lamp Mogul Base</p> 	<p>4-80-20 5000385</p> <p>4-80-25 5000386</p> <p>4-80-40 5000387</p>	<p>60,000 Hour Non-cycling 200 Watt</p> <p>250 Watt</p> <p>400 Watt</p>	<p>SYL LU200/Plus/ XL/Eco</p> <p>SYL LU250/Plus/ XL/Eco</p> <p>SYL LU400/Plus/ XL/Eco</p>

DESCRIPTION OF ITEM	DEPT. CODE NUMBER	SIZE / WEIGHT	ORDERING INFORMATION
<p>Metal Halide Lamp Medium Base</p> 	<p>4-81-07 5000391</p> <p>4-81-40 5000394</p>	<p>70 Watt</p> <p>400 Watt Mogul Base</p>	<p>PHI MHC70/U/M/4K/ELITE</p> <p>PHI CDM330/U/O/4K/ED28</p>
<p>LED Lamp - Warm White</p> <p>LED Lamp - Cool White</p> <p>LED Lamp - Red</p> <p>LED Lamp - Green</p> <p>LED Lamp - Blue</p>	<p>4-82-01 5000395</p> <p>4-82-02 5000396</p> <p>4-82-04 5000397</p> <p>4-82-05 5000398</p> <p>4-82-06 5000399</p>	<p>C7</p>	<p>Specifications 5430</p>
<p>LED Lamp - Warm White</p> <p>LED Lamp - Cool White</p> <p>LED Lamp - Yellow</p> <p>LED Lamp - Red</p> <p>LED Lamp - Green</p> <p>LED Lamp - Blue</p>	<p>4-82-11 5000400</p> <p>4-82-12 5000401</p> <p>4-82-13 5000402</p> <p>4-82-14 5000403</p> <p>4-82-15 5000404</p> <p>4-82-16 5000405</p>	<p>C9</p>	<p>Specifications 5430</p>

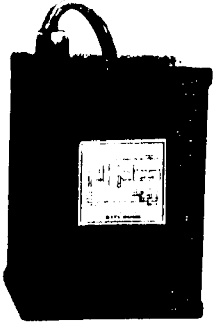
DESCRIPTION OF ITEM	DEPT. CODE NUMBER	SIZE / WEIGHT	ORDERING INFORMATION
Pigtail Socket 	4-83-01 5000406	120 Volt Only	Leviton 55
In-Line Fuse Holder Breakaway For 240 & 347 V 	4-83-05 5000407 4-83-06 5000408	600 Volt 30 Amp 100 kA #12 to #12 600 Volt 30 Amp 100 kA #2 to #6	AM 65U (No Subs) SHAW FEB-41-41-BA BUSS HEB-DW- RLC-B
Photo Electric Cell  Latitude IQ	4-83-10 5001342 4-83-11 5000409 4-83-12 5000410	120 Volt 1000 Watt 120 Volt 1800 Watt 120 Volt Green	FP 7760 SS9 PREC EXDV-AP-TD INT LED4536SC INT LC4536

DESCRIPTION OF ITEM	DEPT. CODE NUMBER	SIZE / WEIGHT	ORDERING INFORMATION
<p>Photo Electric Cell Bracket 3 Prong Type</p> 	<p>4-83-20 5001343</p>		<p>FP S476-71 PREC M2A</p>
<p>Photo Electric Cell Shorting Cap</p> 	<p>4-83-25 5001344</p>	<p>Min 15A Max 480V</p>	<p>FP FPS1039 PREC JP275 Ripley Lighting Controls 6005M-320V</p>
<p>Street Light Relay Double Pole</p> 	<p>4-83-30 5000411</p>	<p>100 Amp 120/240 Volt</p>	<p>Dwg L2-210</p>

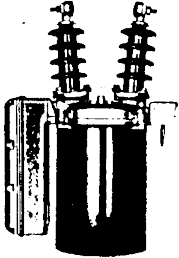
DESCRIPTION OF ITEM	DEPT. CODE NUMBER	SIZE / WEIGHT	ORDERING INFORMATION
<p>Contactor - Three Pole</p> 	<p>4-83-35 5000412</p> <p>4-83-36 5000413</p>	<p>60 Full Amp 75 Resistance Load Amps</p> <p>90 Full Amp 120 Resistance Load Amps Coil 120 Volt</p>	<p>Sq D 8910DPA63V02</p> <p>Sq D 8910DPA93V02</p>
<p>Coils</p>  <p>For 60A Contactor</p> <p>For 90A Contactor</p>	<p>4-83-40 5000414</p> <p>4-83-41 5000415</p> <p>4-83-42 5000416</p> <p>4-83-43 5000417</p>	<p>120 Volt</p> <p>240 Volt</p> <p>120 Volt</p> <p>240 Volt</p>	<p>Sq D 9998DA2V02</p> <p>Sq D 9998DA2V09</p> <p>Sq D 9998DA3V02</p> <p>Sq D 9998DA3V09</p>
<p>Primary Oil Switch Single Phase (Solenoid operated)</p> 	<p>4-83-50 5000418</p>	<p>70 Amp 2400 Volt</p>	



DESCRIPTION OF ITEM	DEPT. CODE NUMBER	SIZE / WEIGHT	ORDERING INFORMATION
<p>Circuit Breaker 1 Pole</p> 	<p>4-83-55 5000419</p>	<p>120/240 Volt 15 Amp</p>	<p>SQ D QOU115</p>
<p>Circuit Breaker 2 Pole</p>	<p>4-83-60 5000420</p> <p>4-83-65 5000421</p>	<p>120/240 Volt 60 Amp</p> <p>120/240 Volt 100 Amp</p>	<p>SQ D QOU 260</p> <p>SQ D QOU 2100</p>
<p>Weatherhead For Overbraced Street Light Pole</p>	<p>4-83-75 5000422</p>	<p>3/4" CAST ALUMINUM SERVICE ENTRANCE</p>	<p>IBV CIEFSA-3/4</p>

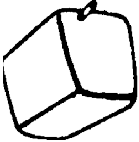

DESCRIPTION OF ITEM	DEPT. CODE NUMBER	SIZE / WEIGHT	ORDERING INFORMATION
<p>Power Distribution Block</p> 	<p>4-84-10 5000423</p>	<p>3 Pole/460 Amps</p>	<p>ILS PDB-212-4/0-3</p>
<p>LED Retro Fit Kit for Invue Fixture</p>	<p>4-92-05 5000441</p> <p>4-92-10 5000442</p> <p>4-92-25 5000443</p>	<p>25 Watt replaces 50 Watt MH 120/240 Volt</p> <p>50 Watt replaces 100 Watt MH 120/240 Volt</p> <p>125 Watt replaces 250 Watt MH 120/240 Volt</p>	<p>CP PDR64597-FLS- E01-LED-E1-T3- GM-RETRO</p> <p>CP PDR60272-SDS- E02-LED-E1-T3- GM-RETRO</p> <p>CP PDR60271-SDM- E05-LED-E1-T3- GM-RETRO</p>
<p>Ballast for Pedestrian Fixture</p>	<p>4-92-45 5000444</p> <p>4-92-50 5000445</p>	<p>50 Watt MH 120/277/347 Volt</p> <p>100 Watt MH 120/277/347 Volt</p>	<p>STAN 10067</p> <p>STAN 10069</p>

DESCRIPTION OF ITEM	DEPT. CODE NUMBER	SIZE / WEIGHT	ORDERING INFORMATION
<p>Refractor</p> <p>Wallpack Fixture</p>  <p>PTL Fixture Trouble Shift</p>	<p>4-93-10 5000446</p> <p>4-93-11 5000447</p>	<p>100 Watt HPS Glass or Acrylic</p> <p>100 Watt</p>	<p>HOL 579B</p> <p>AE RK245 R2/R3 AY</p>
<p>Black Acorn Globe for Washington Fixture</p>	<p>4-93-20 5000448</p> <p>4-93-22 5000449</p>	<p>50 Watt</p> <p>100/250 Watt</p>	<p>DIV HS1-BLK</p> <p>HOL AA250HP3NSBTR Optic Assembly</p>
<p>Banner Hardware</p> <p>Bracket Black</p> <p>Arm</p>	<p>4-95-01 5000450</p> <p>4-95-02 5000451</p>	<p>Black</p> <p>31" Black Casting Fibreglass Rod</p>	<p>BannerFlex D3</p> <p>BannerFlex D3</p>



DESCRIPTION OF ITEM	DEPT. CODE NUMBER	SIZE	ORDERING INFORMATION
Parallel Groove Copper Compression Connector 	5-00-01 5001345 5-00-02 5001346 5-00-04 5001347 5-00-05 5001348	4 STR - 6 STR 4 STR - 4 STR 2 STR - 4 STR 2 STR - 2 STR	BUR Crimpit YC4C6 ILS ULT-4-Z T&B BC46 BUR Crimpit YC4C4 ILS ULT-5-Z T&B BC44 BUR Crimpit YC2C4 ILS ULT-6-Z T&B BC24 BUR Crimpit YC2C2 ILS ULT-7-Z T&B BC22
Parallel Groove Copper Compression Connector 	5-00-06 5001349 5-00-07 5001350 5-00-08 5001351	1/0 2/0 STR - 1/0 2/0 STR 3/0-4/0 - #6-#2 3/0 4/0 - 1/0 2/0 STR	BUR Crimpit YC26C26 T&B BC2020 ILS ULT-9-Z T&B CC402 HOM CC402 BUR Crimpit YC28C2 ILS ULT-10-Z BUR Crimpit YC28C26 HOM CC4020 T&B BC4020 ILS ULT-11-Z
Parallel Groove Copper Compression Connector 	5-00-09 5001352	3/0 4/0 - 3/0 4/0 STR	BUR Crimpit YC28C28 ILS ULT12-Z T&B BC4040



DESCRIPTION OF ITEM	DEPT. CODE NUMBER	SIZE	ORDERING INFORMATION
<p>Copper Compression Connector - Grounding</p> 	<p>5-00-12 5001353</p> <p>5-00-14 5001354</p>	<p>#2 2/0 STR 5/8" Rod</p> <p>300 500 MCM 5/8" Rod</p>	<p>BUR YGHR 26C58 ILS RLT3 T&B GR58-202</p> <p>BUR YGHR 34C58 ILS RLT8 T&B GR58-300500</p>
<p>Copper Compression Connector - Grounding</p> 	<p>5-00-16 5001355</p> <p>5-00-17 5001356</p>	<p>2/0 to #8, #2</p> <p>300 - 500 MCM Run to 300 - 500 MCM Tap</p>	<p>BUR YC26C2 T&B BC202</p> <p>BUR YGHC34C34 T&B CTP500500</p>
<p>Copper Compression Connector - Grounding</p> 	<p>5-00-18 5001357</p> <p>5-00-19 5001358</p>	<p>1/0, 2/0 STR 250, 500 MCM</p> <p>350 MCM Run to 350 MCM Tap</p>	<p>BUR YGHP 34C26 ILS GGC-6 T&B 54890</p> <p>BUR YGHP 34C34 ILS GGC-8 T&B 54900</p>

DESCRIPTION OF ITEM	DEPT. CODE NUMBER	SIZE	ORDERING INFORMATION
<p>Parallel Groove Aluminum Compression Connector for Copper, Aluminum, ACSR, AAAC & 5005</p> 	<p>5-00-30 5023024</p> <p>5-00-31 5000452</p> <p>5-00-32 5000453</p>	<p>3/0, 2/0, 1/0 STR 2/0, 1/0, 1 ACSR</p> <p>St. Ltg. Trp. 6, 4 ACSR 2, 4 ACSR Comp. 6, 4, 2 STR Alum & Cu 14 SOL, 8 STR Alum & CU</p> <p>6, 4, 3, 2 SOL - 6, 4, 3, 2 SOL 6, 4, 3 STR 6, 4 ACSR - 6, 4 ACSR</p>	<p>BLK WR279</p> <p>BLK WR9 NO SUBS</p> <p>BLK WR159 NO SUBS</p>
<p>Parallel Groove Aluminum Compression Connector for Copper, Aluminum, ACSR, AAAC & 5005</p> 	<p>5-00-33 5000454</p> <p>5-00-34 5000455</p>	<p>2, 1, 1/0, 2/0 STR - 6, 4, 3, 2 1 STR 2, 1, 1/0 2/0 ACSR - 6, 4 3, 2, 1 ACSR</p> <p>1/0, 2/0 STR - 1/0, 2/0 STR 1/0, 2/0 ACSR - 1/0, 2/0 ACSR</p>	<p>BLK WR189 NO SUBS</p> <p>BLK WR259 NO SUBS</p>
<p>Parallel Groove Aluminum Compression Connector for Copper, Aluminum, ACSR, AAAC & 5005</p> 	<p>5-00-35 5000456</p> <p>5-00-36 5000457</p>	<p>2/0, 3/0 STR - 3, 2, 1 STR 1/0, 2/0, 3/0 ACSR - 4, 3, 2, 1 ACSR</p> <p>4/0, 250 STR - 3/0, 4/0 250 STR 3/0, 4/0 ACSR - 3/0, 4/0 ACSR</p>	<p>BLK WR289 NO SUBS</p> <p>BLK WR419 NO SUBS</p>

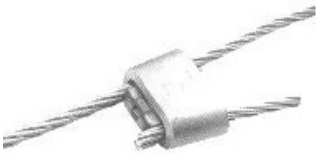

DESCRIPTION OF ITEM	DEPT. CODE NUMBER	SIZE	ORDERING INFORMATION
<p>Parallel Groove Aluminum Compression Connector for Copper, Aluminum, ACSR, AAAC & 5005</p> 	<p>5-00-37 5000458</p> <p>5-00-38 5000459</p> <p>5-00-39 5000460</p>	<p>4/0, 250 STR - 1/0, 2/0, 3/0 STR 4/0 ACSR - 1/0 2/0 ACSR</p> <p>4/0, 250 STR - 3, 2, 1 STR 4/0 ACSR - 4, 3, 2, 1 ACSR</p> <p>477 MCM STR - 4, 2/0 STR 477 MCM ACSR - 6, 1/0 ACSR</p>	<p>BLK WR399 NO SUBS</p> <p>BLK WR379 NO SUBS</p> <p>BLK WR815 NO SUBS</p>
<p>Parallel Groove Aluminum Compression Connector for Copper, Aluminum, ACSR, AAAC & 5005</p> 	<p>5-00-41 5000461</p> <p>5-00-43 5000462</p> <p>5-00-45 5000463</p>	<p>336, 477 ACSR - 250, 500 STR 2/0, 4/0 ACSR - 2/0, 4/0 STR</p> <p>336, 477 ACSR 250, 500 STR - 336 ACSR 250, 350 STR</p> <p>477 ACSR/Alum - 477ACSR/Alum</p>	<p>BLK WR835 NO SUBS</p> <p>BLK WR875 NO SUBS</p> <p>BLK WR885 NO SUBS</p>
<p>Split Bolt Connector For Copper to Copper</p> 	<p>5-01-01 5001359</p> <p>5-01-02 5001360</p> <p>5-01-04 5001361</p>	<p>MAIN Max-6 SOL Min-10 SOL TAP Max-6 SOL Min-12 SOL</p> <p>MAIN-#2 STR TAP Max-#2 STR Min-#14 STR</p> <p>MAIN-#4 STR TAP Max-#4 STR Min-#14 STR</p>	<p>BLK 6H BUR KS-17 ILS IK-6</p> <p>BLK 1H BUR KS23 ILS IK-2</p> <p>BLK 2H BUR KS22 ILS IK3</p>

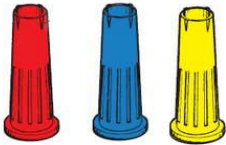
DESCRIPTION OF ITEM	DEPT. CODE NUMBER	SIZE	ORDERING INFORMATION
<p>Split Bolt Connector For Copper to Copper</p> 	<p>5-01-06 5001362</p> <p>5-01-07 5001363</p> <p>5-01-08 5001364</p>	<p>MAIN-#6 STR TAP Max-#6 STR Min-#14 STR</p> <p>2/O</p> <p>MAIN Max-250 Min-2/0 TAP Max-250 Min-8 SOL</p>	<p>BLK 4H BUR KS20 ILS IK-4</p> <p>BLK 20H BUR KS26 ILS IK-2/O</p> <p>BLK 40H ILS IK-250</p>
<p>Split Bolt Post Connector for Cable to Flat Bar</p> 	<p>5-01-12 5001365</p> <p>5-01-13 5001366</p>	<p>10, 3 STR - 10, 2 SOL 3/8" - 16 Stud</p> <p>2/O</p>	<p>BUR KC22 T&B SP3SL PU SSS-3A1</p> <p>BUR KC26B1 T&B SP6SL PU SSS-6A1</p>
<p>Two Bolt Connector</p> 	<p>5-01-22 5001367</p>	<p>Up to 800 MCM</p>	<p>BUR KVSU40 ILS IKB-800</p>



DESCRIPTION OF ITEM	DEPT. CODE NUMBER	SIZE	ORDERING INFORMATION
Bonding Jumper Clamp 	5-01-30 5000464	#6 CU - 1/4"STR	BLK K1
Ampact Connector 	5-02-05 5000465 5-02-07 5000466 5-02-09 5000467 5-02-13 5000468 5-02-15 5000469 5-02-17 5000470	2/0-2/0, 3/0-1/0, 4/0-2 4/0 - 2/0 4/0 - 4/0 336 - 4/0 336 - 336 477 - 2/0	AMP 600411 AMP 600459 AMP 600466 AMP 602004 AMP 602007 AMP 1-602031-8
Ampact Connector 	5-02-19 5000471 5-02-21 5000472 5-02-22 5000473 5-02-24 5000474 5-02-27 5000475 5-02-29 5000476	477 - 4/0 477 - 336 477 - 477 750 - 336 750 - 4/0 750 - 477	AMP 1-602031-6 AMP 1-602031-4 AMP 1-602031-3 AMP 602121-7 AMP 602121-9 AMP 602121

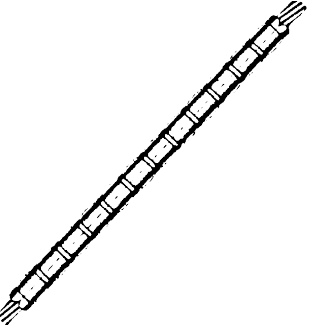

DESCRIPTION OF ITEM	DEPT. CODE NUMBER	SIZE	ORDERING INFORMATION
<p>Ampact Deadend Connector</p> 	<p>5-02-30 5025366</p> <p>5-02-32 5025368</p> <p>5-02-34 5025370</p> <p>5-02-36 5025372</p>	<p>4/0 AAC & ACSR</p> <p>266 ACSR, 336 AAC & ACSR</p> <p>477 AAC</p> <p>477 ACSR</p>	<p>AMP 83843-7</p> <p>AMP 83843-2</p> <p>AMP 83843-3</p> <p>AMP 83843-4</p>
<p>Ampact Shell</p> <p>Blue</p> <p>Red</p> <p>Yellow</p> <p>White</p> 	<p>5-02-41 5000477</p> <p>5-02-42 5000478</p> <p>5-02-44 5000479</p> <p>5-02-46 5000480</p>		<p>AMP 69338-1</p> <p>AMP 69338-2</p> <p>AMP 69338-4</p> <p>AMP 69338-5</p>
<p>Ampact Insulated Cover</p> 	<p>5-02-52 5000481</p> <p>5-02-53 5000482</p>	<p>Medium</p> <p>Large</p>	<p>AMP 602107</p> <p>AMP 602284 HOM PT-COVER-C</p>

DESCRIPTION OF ITEM	DEPT. CODE NUMBER	SIZE	ORDERING INFORMATION
<p>Connectors Stirrup Aluminum Tap System</p> 	<p>5-02-69 5000483</p> <p>5-02-70 5000484</p> <p>5-02-72 5000485</p> <p>5-02-74 5000486</p> <p>5-02-76 5000487</p> <p>5-02-78 5000488</p>	<p>#6, #4</p> <p>#2</p> <p>1/0 - 2/0</p> <p>3/0 - 4/0</p> <p>336</p> <p>477</p>	<p>AMP 602585</p> <p>AMP 602586</p> <p>AMP 600464</p> <p>AMP 600469</p> <p>AMP 600474</p> <p>AMP 60204</p>
<p>Connector Stirrup Clamp Style</p> 	<p>5-03-01 5000489</p> <p>5-03-03 5000490</p>	<p>#4 - 1/0</p> <p>2/0 - 477</p>	<p>EPAC ASB-6-4/0 RIC BCASC2/0-E-W-45</p> <p>RIC BCASC397-E-45</p>
<p>Connector Stirrup Shearbolt Style</p> 	<p>5-03-10 5000491</p>	<p>Use With</p> <p>#6 - #2 AL/CU</p>	<p>CPI102011-2</p>

DESCRIPTION OF ITEM	DEPT. CODE NUMBER	SIZE	ORDERING INFORMATION
Compression Sleeve Copper and Copperweld Full Tension 	5-04-02 5000492 5-04-03 5000493	2/0 (7, 19) STR 4/0 (7, 19) STR	BUR Hysplice YDS26 BUR Hysplice YDS28
Compression Sleeve Copper & Copperweld Full Tension 	5-04-07 5000494 5-04-08 5000495 5-04-09 5000496 5-04-10 5000497 5-04-11 5000498 5-04-12 5000499	#4 - #6 SOL Copper #6 SOL Copper #4 SOL Copper #2 SOL #4 STR Copper 3/0 SOL 2/0 STR Copper #2 SOL to #4 SOL	SL Nico Press 1-204X162P BUR YDS6W BUR YDS4W BUR YDS2W SL Nico Press 1-365/7G3 SL Nico Press Reducer 1-258X204X
Compression Sleeve Copper Repair 	5-04-22 5000500	4/0 STR	BUR YCU28



DESCRIPTION OF ITEM	DEPT. CODE NUMBER	SIZE	ORDERING INFORMATION
Compression Sleeve Aluminum Full Tension 	5-04-34 5000501 5-04-35 5000502 5-04-36 5000503 5-04-37 5000504	2/0 Alum 4/0 Alum 336 MCM 477 MCM	BUR YDS26AT BUR YDS28AT BUR YDS301AT HOM 2176 BUR YDS331AT
Compression Sleeve Aluminum Jumper 	5-04-41 5000505 5-04-42 5000506 5-04-43 5000507 5-04-44 5000508	4/0 Alum 336 MCM Alum 477 MCM Alum 477 MCM ACSR	BUR YCS28RL BUR YCS321R BUR YCS35R HOM 874 BUR YCS36R
Compression Sleeve ACSR Repair	5-04-47 5000509	4/0 ACSR	BUR YVU28R

DESCRIPTION OF ITEM	DEPT. CODE NUMBER	SIZE	ORDERING INFORMATION
Compression Sleeve Aluminum Repair 	5-04-50 5000510 5-04-51 5000511	336.4 MCM 477 MCM	BUR YCU301A BUR YOU331A
Compression Sleeve Combination Aluminum & ACSR Full Tension 	5-04-62 5000512 5-04-63 5000513	2/0 4/0	BUR Unisplice YDS26RL BUR Unisplice YDS28RL
Compression Sleeve ACSR Full Tension 	5-04-75 5000514 5-04-76 5000515 5-04-77 5000516 5-04-78 5000517 5-04-79 5000518	477 MCM Alum Section 477 MCM Steel Section 266 MCM Alum Section 266 MCM Steel Section 336 MCM Oriole Steel Section	BUR YDS37RP1 BUR YDS36RP2 BUR YDS30RP1 BUR YDS30RP2 BUR YDS33R

DESCRIPTION OF ITEM	DEPT. CODE NUMBER	SIZE	ORDERING INFORMATION
Automatic Splice 	5-04-84 5000519 5-04-86 5000520 5-04-88 5000521 5-04-89 5000522 5-04-90 5001368 5-04-92 5001369 5-04-94 5000523	2/0 ACSR 2/0 Copper 4/0 ACSR 4/0 Copper 336 ALUM 477 ALUM 477 ACSR 26/7 Strand	REL 7654AP REL 207 REL 7656 REL 407 REL 7658AP FAR GL410 MP 7659 BLK ATS397477 HUB GLSF412 HUB GLSF412KR HUB GLT1319A NO SUBS
Compression Sleeve Steel Guy Strand Full Tension 	5-04-98 5000524 5-04-99 5000525	3/8 Steel Wire 5/16" Grade 110	SL 5-7/120G92 SLNico Press 5-7/104W
Compression Sleeve Insulated Service Entrance 	5-05-02 5001370 5-05-05 5001371 5-05-06 5001372 5-05-07 5001373	6 ACSR - 6 ACSR Blue-Blue 4 ACSR - 6 ACSR Orange-Blue 4 ACSR - 4 ACSR Orange-Orange 2 ACSR - 6 ACSR Red-Blue	BLK ICS64 BUR ES6R6R PU P1K44 BLK ICS67 BUR ES4R6R PU P1K24 BLK ICS68 ILS P1K22 BLK ICS71 BUR ES2R6R PU P1K14

DESCRIPTION OF ITEM	DEPT. CODE NUMBER	SIZE	ORDERING INFORMATION
Compression Sleeve Insulated Service Entrance 	5-05-08 5001374 5-05-09 5001375	2 ACSR - 4 ACSR Red-Orange 2 ACSR - 2 ACSR Red-Red	BUR ES2R4R BLK ICS72 PU P1K12 BUR ES2R2R BLK ICS73 PU P1K11
Compression Sleeve Insulated Service Entrance 	5-05-10 5001376 5-05-11 5001377 5-05-12 5001378 5-05-13 5001379	1/0 - #2 Yellow-Red 2/0 - #2 Grey-Red 2/0 - 2/0 Grey-Grey 3/0 - #2 Black-Red	BLK IKL35 PU P1K01 BLK IKL45 PU P1K201 BLK IKL47 PU P1K2020 BLK IKL55 PU P1K301
Compression Sleeve Insulated Service Entrance 	5-05-14 5001380 5-05-15 5001381 5-05-16 5001382 5-05-20 5023007 5-05-22 5023017	4/0 - #2 Pink-Red 4/0 - 2/0 Pink-Grey 4/0 - 4/0 Pink-Pink 2/0 - 1/0 4/0 - 1/0	BLK IKL65 PU P1K401 BLK IKL67 PU P1K4020 BLK IKL69 PU P1K4040 BLK IKL46 BLK IKL66

DESCRIPTION OF ITEM	DEPT. CODE NUMBER	SIZE	ORDERING INFORMATION
<p>Connector Insulation Piercing</p> 	<p>5-05-24 5025436</p> <p>5-05-26 5025438</p>	<p>#6 - 3/0 Main #12 - #2 Tap</p> <p>#4 - 4/0 Main & Tap</p>	<p>TE P2X95 U Mk2</p> <p>TE P3X4/0</p>
<p>Compression Sleeve Noninsulated Service Entrance</p> 	<p>5-05-33 5001383</p> <p>5-05-34 5000526</p> <p>5-05-35 5000527</p>	<p>6 ACSR</p> <p>4 ACSR or ALUM</p> <p>2 ACSR or ALUM</p>	<p>BUR YSS6RG2 HOM SNG66 NO SUBS</p> <p>HOM SNG44</p> <p>HOM SNG22</p>
<p>GelCap c/w Connector For Streetlight Connections</p> 	<p>5-05-70 5000528</p> <p>5-05-74 5000529</p>	<p>600 V #14-2/0</p> <p>600 V #14-2/0 4 Conductor</p>	<p>RAY GelCap SL 2/0-3 hole</p> <p>TYCO GTap-2</p>

DESCRIPTION OF ITEM	DEPT. CODE NUMBER	SIZE	ORDERING INFORMATION
Tinned Copper Compression Sleeve 	5-06-29 5001384 5-06-31 5001385 5-06-32 5001386 5-06-33 5001387 5-06-35 5001388	#6 STR #4 STR #2 STR #1 STR 2/0 STR	BUR YS-6C ILS CTL-6 BUR YS-4C ILS CTL-4 BUR YS-2C PAND SCL2-Q ILS CTL-2 BUR YS-1C ILS CTL-1 BUR YS-26 PAND SCL2/0X ILS CTL-2/0
Tinned Copper Compression Sleeve 	5-06-37 5001389 5-06-38 5001390 5-06-39 5001391 5-06-40 5001392 5-06-42 5001393 5-06-50 5000530	4/0 STR 250 MCM 350 MCM 500 MCM 750 MCM 500 - 750 MCM Transition	BUR YS-28 ILS CTL-4/0 BUR YS-29 ILS CTL-250 BUR YS-31 ILS CTL-350 BUR YS-34 ILS CTL-500 BUR YS-39 ILS CTL-750 3M2000T 500-750 cu/al
Sleeve Compression AL Non-Insulated 	5-06-60 5022804	1/0 - 1/0	Ilsco ASN-1/0 Blackburn CS78 Homac U1B1010

DESCRIPTION OF ITEM	DEPT. CODE NUMBER	SIZE	ORDERING INFORMATION
<p>Buchanan Splice Sleeve</p>  <p>Buchanan Insulator Cap</p> 	<p>5-07-01 5000531</p> <p>5-07-03 5000532</p> <p>5-07-05 5000533</p> <p>5-07-07 5000534</p>	<p>Small</p> <p>Large</p> <p>Small</p> <p>Large</p>	<p>BUCH 2006S 100 pieces/box</p> <p>BUCH 2011S 50 pieces/box</p> <p>BUCH 2007</p> <p>BUCH 2014</p>
<p>Luminaire Disconnect</p>  	<p>5-07-15 5021127</p> <p>5-07-17 5021129</p>	<p>2 Wire</p> <p>3 Wire</p>	<p>IDI PowerPlug 30-102</p> <p>IDI PowerPlug 30-103X</p>
<p>Bolted Lug - 1 Hole</p> 	<p>5-08-01 5000535</p> <p>5-08-02 5000536</p> <p>5-08-03 5000537</p> <p>5-08-04 5000538</p>	<p>1/0 - 2/0</p> <p>3/0 - 4/0</p> <p>250 - 350</p> <p>400 - 500</p>	<p>BUR Qiklug QA-26-B</p> <p>BUR Qiklug QA-28-B</p> <p>BUR Qiklug QA-31-B</p> <p>BUR Qiklug QA-34-B</p>

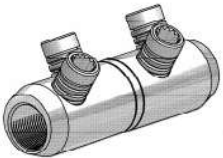
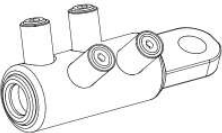
DESCRIPTION OF ITEM	DEPT. CODE NUMBER	SIZE	ORDERING INFORMATION
Bolted Lug 	5-08-54 5000539 5-08-55 5000540 5-08-56 5000541	Min #14 Max #8 Min #14 Max #4 Min #4 Max 2/0	T&B L35 T&B L70 T&B Cone Screw Lug 71010
Shearbolt Splice Connector 	5-08-65 5001394 5-08-70 5001395 5-08-75 5000542	#2 - 250 MCM For use with 7-92-13 4/0 - 500 MCM For use with 7-92-15 350 MCM - 750 MCM For use with 7-92-16 & 7-92-17	3M USMF-1 PRY CUS53821 3M USMF-2 PRY CUS53783 PRY CUS53826
Shearbolt Lug Connector Threaded 	For Use with 6-70-50, 6-70-55 Elbow & 15/25kV LRTP 5-08-80 5000543 5-08-85 5000544	#3 AWG - 300 MCM 15/16" Threaded Hole Bimetal 350 - 750 MCM 15/16" Threaded Hole Bimetal	RICHARDS/3M P6AL-R1-15/16 RICHARDS/3M P6AL-R4-15/16

DESCRIPTION OF ITEM	DEPT. CODE NUMBER	SIZE	ORDERING INFORMATION
<p>Shearbolt Lug Connector Non-Threaded</p> 	<p>For Use with 6-70-50, 6-70-55 Elbow & Plug & Cap</p> <p>5-08-91 5001495</p> <p>5-08-94 5001496</p>	<p>#3 AWG - 300 MCM 11/16" Non-Threaded Bimetal</p> <p>350 - 750 MCM 11/16" Non-Threaded Bimetal</p>	<p>RICHARDS/3M P6AL-R1</p> <p>RICHARDS/3M P6AL-R4</p>
<p>Compression Type Lug for ACSR, Aluminum or Copper - 2 Hole Nema</p> 	<p>5-09-00 5000545</p> <p>5-09-01 5001396</p> <p>5-09-02 5001397</p>	<p>#2</p> <p>2/0</p> <p>4/0</p>	<p>BLK AL4</p> <p>BLK AL8 T&B SA 2/0 N</p> <p>BLK AL12 T&B SA 4/0-N</p>
<p>Compression Type Lug for ACSR or Aluminum 2 Hole Nema</p> 	<p>5-09-03 5001398</p> <p>5-09-04 5024983</p> <p>5-09-05 5001399</p> <p>5-09-06 5001400</p>	<p>336 ALUM</p> <p>266 ACSR</p> <p>477 ALUM</p> <p>477 ACSR</p>	<p>BUR Hylug YCA321R-2N HOM SAB400N</p> <p>HOM SA350NTN</p> <p>BUR Hylug YCA35R-2N HOM AL500NTN BLK AL24</p> <p>BUR Hylug YCA37R-2N HOM AL600NTN</p>

DESCRIPTION OF ITEM	DEPT. CODE NUMBER	SIZE	ORDERING INFORMATION
<p>Compression Type Lug Copper - 1 Hole</p> 	<p>5-09-07 5001401</p> <p>5-09-08 5001402</p> <p>5-09-09 5000546</p>	<p>1/2" Stud #4 UC</p> <p>#2 Short Barrel</p> <p>2/0</p>	<p>PAND LCA4-12-L ILS CSWS-4-12</p> <p>PAND LCA2-12-Q T&B X54145 NO SUBS</p> <p>T&B 54951BE</p>
<p>Compression Type Lug for Copper - 2 Hole</p> 	<p>5-09-10 5001403</p> <p>5-09-11 5001404</p> <p>5-09-12 5001405</p> <p>5-09-13 5001406</p>	<p>2/0</p> <p>4/0</p> <p>250 MCM</p> <p>350 MCM</p>	<p>BUR Hylug YA26-2N ILS CLND-2/0-12-134 T&B 54862BE</p> <p>BUR Hylug YA28-2N PAND LCC4/0-12 ILS CLND-4/0-12-134 T&B 54866BE</p> <p>BUR Hylug YA29-2N PAND LCC250-12 ILS CLND-250-12-134 T&B 54868BE</p> <p>BUR Hylug YA31-2N PAND LCC350-12 ILS CLND-350-12-134 T&B 54872BE</p>
<p>Compression Type Lug for Copper - 2 Hole</p> 	<p>5-09-14 5001407</p> <p>5-09-15 5001408</p> <p>5-09-16 5001409</p>	<p>500 MCM</p> <p>750 MCM</p> <p>1000 MCM</p>	<p>BUR Hylug YA34-2N PAND LCC500-12 ILS CLND-500-12-134 T&B 54876BE</p> <p>BUR Hylug YA39-2N PAND LCC750-12 BLK LCN-75 ILS CLND-750-12-134 T&B 54880BE</p> <p>BUR Hylug YA44-2N PAND LCC1000-12 ILS CLND-1000-12-134</p>

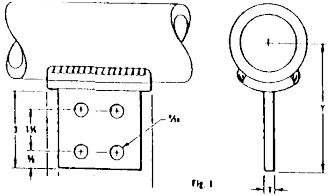
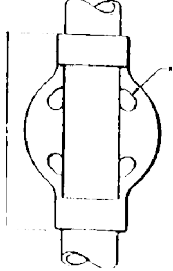
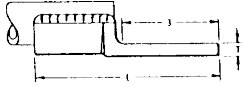
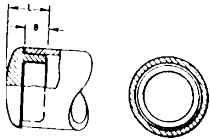

DESCRIPTION OF ITEM	DEPT. CODE NUMBER	SIZE	ORDERING INFORMATION
<p>Compression Type Lug for Copper - 1 Hole Type</p> 	<p>5-09-17 5001410</p> <p>5-09-18 5001411</p> <p>5-09-19 5025078</p>	<p>1/2" Stud #1 CU</p> <p>4/0</p> <p>3/8" Stud #6 CU</p>	<p>PAND LCA1-12-E T&B 54150 3M 40029 BUR YA1CL6</p> <p>BUR YA28 T&B 54970BE</p> <p>PAND LCA6-38-L ILS CSWS-6-38</p>
<p>Compression Type Lug for Copper - Universal Rod</p>  <p>Compression Type Lug for Aluminum - 1 hole 1/0</p> 	<p>5-09-20 5000547</p> <p>5-09-30 5023021</p>	<p>#1</p>	<p>3M SC0001</p> <p>Richards ALCD9</p>
<p>Bolted Type "T" Connector</p> 	<p>5-11-02 5000548</p>	<p>750 MCM Run - 500 MCM Tap for Network</p>	<p>RIC MT23-18 NO SUBS</p>

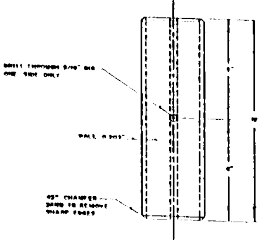
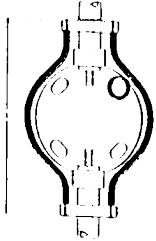
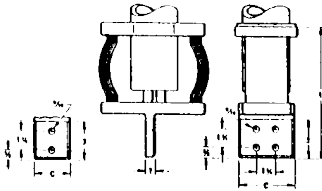
DESCRIPTION OF ITEM	DEPT. CODE NUMBER	SIZE	ORDERING INFORMATION
<p>Station Connector</p> <p>Bar Tap</p> 	<p>5-13-01 5000549</p>	<p>3" IPS 4 N</p>	<p>BUR WAB20A4N</p>
<p>Station Connector</p> <p>Bus Support</p> 	<p>5-13-02 5000550</p>	<p>3" IPS 5" B.C.</p>	<p>BUR WOH20A5</p>
<p>Station Connector</p> <p>End Terminal Centre Formed</p>  <p>Corona Bell</p> 	<p>5-13-03 5000551</p> <p>5-13-04 5000552</p>	<p>3" IPS 4N</p> <p>3" IPS</p>	<p>BUR WAC20A4N</p> <p>BUR LB20A</p>

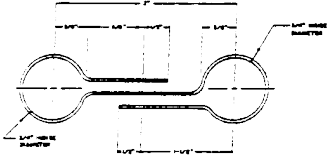
DESCRIPTION OF ITEM	DEPT. CODE NUMBER	SIZE	ORDERING INFORMATION
<p>Station Connector</p> <p>Bus Coupler</p> 	<p>5-13-05 5000553</p>	<p>3" IPS 12"</p>	<p>Dwg. Gs-249</p>
<p>Station Connector</p> <p>Expansion Bus Support Coupler</p> 	<p>5-13-06 5000554</p>	<p>3" IPS 5" B.C.</p>	<p>BUR WXHP20A5</p>
<p>Station Connector</p> <p>Expansion Terminal Center Formed</p> 	<p>5-13-07 5000555</p>	<p>3" IPS 4 N</p>	<p>BUR WXA20A4N</p>



DESCRIPTION OF ITEM	DEPT. CODE NUMBER	SIZE	ORDERING INFORMATION
<p>Station Connector</p> <p>Separator for 477 Cosmos</p> 	<p>5-13-08 5000556</p>	<p>477 ALUM 3"</p>	<p>Dwg. Gs-248</p>

DESCRIPTION OF ITEM	DEPT. CODE NUMBER	SIZE / WEIGHT	ORDERING INFORMATION
Padmount Transformer Single Phase - Livefront 4160/2400 - 120/240	6-10-13 5000557	167 KVA	Specification 17 & Addendum
Padmount Transformer Single Phase - Deadfront Dual Voltage 2400 - 120/240 8320 - 120/240 200 Amp Bushings	6-10-25 5001412 6-10-27 5000558	50 KVA 75 KVA	Specification 2132 & Addendum Specification 2132 & Addendum
Padmount Transformer Single Phase - Deadfront Dual Voltage 2400 - 120/240 8320 - 120/240 600 Amp Bushing 	6-11-05 5000559 6-11-07 5000560 6-11-09 5000561 6-11-13 5000562	50 KVA 75 KVA 100 KVA 167 KVA	Specification 2131 & Addendum Specification 2131 & Addendum Specification 2131 & Addendum Specification 2131 & Addendum



DESCRIPTION OF ITEM	DEPT. CODE NUMBER	SIZE / WEIGHT	ORDERING INFORMATION
<p>Padmount Transformer Single Phase - Deadfront Dual Voltage 2400 - 240/480 8320 - 240/480</p> 	<p>6-12-05 5000563</p>	<p>50 KVA</p>	<p>Specification 2132 & Addendum</p>
<p>Padmount Transformer Single Phase - Deadfront 8320 - 120/240</p> 	<p>6-13-05 5000564</p> <p>6-13-07 5000565</p> <p>6-13-09 5000566</p> <p>6-13-13 5000567</p>	<p>50 KVA</p> <p>75 KVA</p> <p>100 KVA</p> <p>167 KVA</p>	<p>Specification 2104 & Addendum</p> <p>Specification 2104 & Addendum</p> <p>Specification 2104 & Addendum</p> <p>Specification 2104 & Addendum</p>
<p>Padmount Transformer Single Phase - Deadfront 14400 - 120/240</p> 	<p>6-14-03 5000568</p> <p>6-14-05 5000569</p> <p>6-14-07 5000570</p> <p>6-14-09 5000571</p> <p>6-14-13 5000572</p>	<p>37.5 KVA</p> <p>50 KVA</p> <p>75 KVA</p> <p>100 KVA</p> <p>167 KVA</p>	<p>Specification 2104 & Addendum</p> <p>Specification 2104 & Addendum</p> <p>Specification 2104 & Addendum</p> <p>Specification 2104 & Addendum</p> <p>Specification 2104 & Addendum</p>

DESCRIPTION OF ITEM	DEPT. CODE NUMBER	SIZE / WEIGHT	ORDERING INFORMATION
Padmount Transformer Single Phase - Deadfront 14400 - 240/480	6-15-02 5001497	25 KVA	Specification 2104 & Addendum
Padmount Transformer Three Phase - Livefront 4160 - 120/208	6-22-07 5000573	75 KVA	Specification 21 & Addendum
Padmount Transformer Three Phase - Deadfront 4160 - 120/208 Radial Feed 	6-24-13 5000574 6-24-15 5000575 6-24-17 5000576 6-24-19 5000577	150 KVA 225 KVA 300 KVA 500 KVA Approx. 4890 lbs (2222 kgs)	Specification 2114 & Addendum Specification 2114 & Addendum Specification 2114 & Addendum Specification 2114 & Addendum

DESCRIPTION OF ITEM	DEPT. CODE NUMBER	SIZE / WEIGHT	ORDERING INFORMATION
Padmount Transformer Three Phase - Deadfront 4160 - 347/600 Radial Feed	6-28-15 5000578	225 KVA	Specification 2114 & Addendum
	6-28-17 5000579	300 KVA	Specification 2114 & Addendum
	6-28-19 5000580	500 KVA	Specification 2114 & Addendum
	6-28-21 5000581	750 KVA	Specification 2114 & Addendum
Padmount Transformer Three Phase - Deadfront 14.4 KV - 240 Loop Feed	6-29-13 5000582	150 KVA	Specification 2134 & Addendum
Padmount Transformer Three Phase - Deadfront 14.4 KV - 120/208 Radial Feed	6-30-19 5000583	500 KVA	Specification 2114 & Addendum
	6-30-21 5000584	750KVA	Specification 2114 & Addendum
	6-30-23 5000585	1000 KVA Approx. 9020 lbs (4100 kgs)	Specification 2114 & Addendum

DESCRIPTION OF ITEM	DEPT. CODE NUMBER	SIZE / WEIGHT	ORDERING INFORMATION
<p>Padmount Transformer Three Phase - Deadfront 14.4 KV - 120/208 Loop Feed</p> 	<p>6-31-07 5000586</p> <p>6-31-13 5000587</p> <p>6-31-17 5000588</p>	<p>75 KVA</p> <p>150 KVA</p> <p>300 KVA</p>	<p>Specification 2114 & Addendum</p> <p>Specification 2114 & Addendum</p> <p>Specification 2114 & Addendum</p>
<p>Padmount Transformer Three Phase - Deadfront 14.4 KV - 120/208 Loop Feed 600A</p> 	<p>6-31-67 5000589</p>	<p>300 KVA</p>	<p>Specification 2136 & Addendum</p>
<p>Padmount Transformer Three Phase - Deadfront 14.4 KV - 347/600 Loop Feed</p> 	<p>6-33-13 5000590</p> <p>6-33-17 5000591</p> <p>6-33-19 5000592</p> <p>6-33-21 5000593</p> <p>6-33-23 5000594</p>	<p>150 KVA</p> <p>300 KVA</p> <p>500 KVA</p> <p>750 KVA</p> <p>1000 KVA</p>	<p>Specification 2114 & Addendum</p> <p>Specification 2114 & Addendum</p> <p>Specification 2114 & Addendum</p> <p>Specification 2114 & Addendum</p> <p>Specification 2114 & Addendum</p>

DESCRIPTION OF ITEM	DEPT. CODE NUMBER	SIZE / WEIGHT	ORDERING INFORMATION
<p>Padmount Transformer Three Phase - Deadfront 14.4 KV - 347/600 Loop Feed</p> 	<p>6-33-25 5000595</p> <p>6-33-27 5000596</p>	<p>1500 KVA</p> <p>2000 KVA</p>	<p>Specification 2114 & Addendum</p> <p>Specification 2114 & Addendum</p>
<p>Padmount Transformer Three Phase - Deadfront 14.4 KV - 347/600 Radial Feed</p>	<p>6-34-13 5000597</p> <p>6-34-23 5000598</p>	<p>150 KVA</p> <p>1000 KVA</p>	<p>Specification 2114 & Addendum</p> <p>Specification 2114 & Addendum</p>
<p>Padmount Transformer Three Phase - Deadfront 14.4 KV - 4160 Radial Feed</p>	<p>6-36-19 5000599</p> <p>6-36-27 5000600</p>	<p>500 KVA</p> <p>2000 KVA</p>	<p>Specification 2118 & Addendum</p> <p>Specification 2118 & Addendum</p>

DESCRIPTION OF ITEM	DEPT. CODE NUMBER	SIZE / WEIGHT	ORDERING INFORMATION
Padmount Transformer Three Phase - Deadfront 24940 - 120/208 V Loop Feed 	6-40-13 5000601 6-40-15 5000602 6-40-17 5000603	150 KVA 225 KVA 300 KVA	Specification 2114 & Addendum Specification 2114 & Addendum Specification 2114 & Addendum
Padmount Transformer Three Phase - Deadfront 24940 - 347/600 V Radial Feed	6-42-15 5000604 6-42-17 5000605 6-42-19 5000606	225 KVA 300 KVA 500 KVA	Specification 2114 & Addendum Specification 2114 & Addendum Specification 2114 & Addendum
Padmount Transformer Three Phase - Deadfront 24940 - 347/600 V Loop Feed 	6-43-15 5000607 6-43-19 5000608 6-43-23 5000609 6-43-27 5000610	225 KVA 500 KVA 1000 KVA 2000 KVA	Specification 2114 & Addendum Specification 2114 & Addendum Specification 2114 & Addendum Specification 2114 & Addendum



DESCRIPTION OF ITEM	DEPT. CODE NUMBER	SIZE / WEIGHT	ORDERING INFORMATION
Padmount Transformer Three Phase - Deadfront 24940 - 4160 V Radial Feed	6-44-17 5000611 6-44-23 5000612	300 KVA 1000 KVA	Specification 2118 & Addendum Specification 2118 & Addendum
Padmount Transformer Three Phase - Deadfront 24940 - 4160 V Loop Feed 	6-45-15 5000613	225 KVA	Specification 2118 & Addendum
15 KV Switching Cubicle 2 Way - c/w Interrupter 3 Way 321, (600A LI), (200A 3PH FI) 321, (600A LI), (600A 3PH FI) 422, (200A LI), (200A 3PH FI)x2 413, (600A LI), (200A 3PH FI)x3 switch type/sources/interrupter	6-53-01 5000614 6-53-06 5000615 6-53-07 5000616 6-53-08 5000617 6-53-11 5000618 6-53-12 5000619	NOTE: Joslyn Fuses Load Interrupter = LI, Fault Interrupter = FI 600 Amp 600 Amp 600 Amp S&C 933212-M1P103T1-E243 S&C 853212-L2M10P94P103-E135 S&C 934222-M4P94P103ST2-S356 S&C 924132-L2M10P94P103	6-72-06 + 7-51-20 Specification 2220 Spec 2200 & 2210 Spec 2200 & 2210 Spec 2200 & 2210 Spec 2200 & 2210

DESCRIPTION OF ITEM	DEPT. CODE NUMBER	SIZE / WEIGHT	ORDERING INFORMATION
15 KV Switching Cubicle 440, (600A LI) 422, (600A LI), (200A 1PH FI)x2 431, (600A LI), (200A FI) 422, (600A LI), (200A 3PH FI)x2 523, (600A LI x 2), (200A FI x 3) 532, (600A LI x 3), (200A FI x 2) 6 Way - c/w Interrupter - 624	6-53-14 5000620 6-53-15 5001413 6-53-16 5000621 6-53-17 5000622 6-53-19 5000623 6-53-21 5000624 6-53-31 5000625	S&C 934222-L2M10P94P103T0-S411 S&C 934312-M1P103T1-E151 S&C 924222-L2M10P94P103 600 Amp 200 Amp	Spec 2200 & 2210 Spec 2200 & 2210 Spec 2200 & 2210 Spec 2200 & 2210 Spec 2200 & 2210 Spec 2200 & 2210 Spec 2200 & 2210
25 KV Switching Cubicle 3 Way - c/w Interrupter - 321 3 Way - 330 321, (600A LI), (200A 3PH FI) 321, (600A LI), (200A 1PH FI) 4 Way - 440	6-55-03 5000626 6-55-06 5000627 6-55-07 5000628 6-55-09 5000629 6-55-10 5000630	200 Amp 200 Amp 600 Amp S&C 933213-L2M10P94P103T1-E139 S&C 933213-L2M10P94P103T0-E140 200 Amp	Spec 2200 & 2210 Spec 2200 & 2210 Spec 2200 & 2210 Spec 2200 & 2210 Spec 2200 & 2210
25 KV Switching Cubicle 4 Way - c/w Interrupter - 422 422, (600A LI), (200A 1PH FI)x2 422, (600A LI), (200A FI)x2 6 Way - c/w Interrupter - 624 switch type/sources/interrupter	6-55-11 5000631 6-55-15 5001414 6-55-17 5000632 6-55-31 5000633	200 Amp 200 Amp S&C 934223-M1P94T0-E203 600 Amp 200 Amp	Spec 2200 & 2210 Spec 2200 & 2210 Spec 2200 & 2210 Spec 2200 & 2210

DESCRIPTION OF ITEM	DEPT. CODE NUMBER	SIZE / WEIGHT	ORDERING INFORMATION
Precast Concrete Base for Padmount Transformer Three Phase Box Pad	6-58-06 5000634	500 KVA & Up 1.630 x 1.895 x 1.150 m - Pad (64" x 74" x 45") Appr 6650 lbs	Dwg WS-263
Fibreglass Pad for Padmount Transformers Single Phase Short Single Phase Standard 4500 kg/9900 lb Three Phase Large (Can be used S&C 2, 3, & 4 Way Sw Cub) 8200 kg/18,040 lb S&C 2 Way Interrupter	6-59-01 5000635 6-59-02 5000636 6-59-05 5000637 6-59-06 5000638 6-59-08 5000639	42" x 48" x 15" Top opening 26"x 12" 38" x 50" x 28" Top opening 30"x 20" 66" x 58" x 28" Top opening 39"x 15" 69" x 63" x 28" Top opening 45" x 16" (10,000 lbs) 63" x 69" x 28"	Dwg. WS-421 SCT 02902 Dwg. WS-420 SCT 02903 SCT 02911
Fibreglass Pad for Dry Type Transformers	6-59-10 5000640	31" x 25" x 28" No Cut Out	SCT 02909

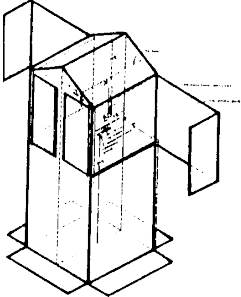
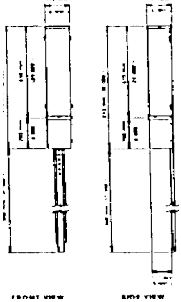
DESCRIPTION OF ITEM	DEPT. CODE NUMBER	SIZE / WEIGHT	ORDERING INFORMATION
Precast Concrete Box Base for Switching Cubicle 3 Way Switch 4 Way Switch	6-61-03 5000641 6-61-05 5000642 Suitable for ABB Solid Dielectric Switch Installation 6-61-07 5000643 6-61-09 5000644	1.524 x 2.222 x .991m 60" x 87" x 39" Approx. 3660 lbs 1.498 x 1.664 x .990m 59" x 66" x 39" Approx 3270 lbs 1.498 x 1.981 x .990m 79" x 60" Approx. 3620 lbs 1.905 x 2.007 x .990m 75" x 79" x 39" Approx. 4080 lbs	Specification 2429 Dwg. WS-241 Specification 2429 Dwg. WS-257 Specification 2429 Dwg WS-264 Specification 2429 Dwg. WS-266
Precast Concrete Box Base for Switching Cubicle Canada Power Products 6 Way	6-61-11 5000645	2.310 x 1.752 x .991m 90" x 69" x 39" Approx. 4420 lbs	Specification 2429 Dwg WS-298
Precast Concrete Box Base for Switching Cubicle For S & C 2, 3 & 4 Way For S & C 3 & 4 Way (old) For S & C 5 & 6 Way For S & C 4 Way	6-61-14 5000646 6-61-15 5000647 6-61-16 5000648 6-61-18 5000649	1.930 x 1651 x 990m 76" x 65" x 39" 1.930 x 1752 x 990m 76" x 69" x 39" Approx. 4713 lbs 2.692 x 1752 x 990m 106" x 69" x 39" Approx. 5972 lbs 87" x 54.25" x 39" Approx. 4000 lbs	Dwg Ws-365 Dwg Ws-361-2 Dwg Ws-362-2 Dwg Ws-422

DESCRIPTION OF ITEM	DEPT. CODE NUMBER	SIZE / WEIGHT	ORDERING INFORMATION
Precast Concrete Box Base for 150 to 500 KVA Transformer	6-61-23 5000650	64" x 56" x 39" 1.626 x 1.422 x .991m	Specification 2429 Dwg Ws-383
Pedestal Joint Use 	6-63-02 5001415 6-63-03 5000651	secondary buss panel for 6-63-03 24" x 24" x 48" (no secondary buss)	Dwg W-221-2 Dwg W-221-3
Pedestal - Street Lighting 	6-63-04 5000652	10" x 10" x 32"	SMW 2114

DESCRIPTION OF ITEM	DEPT. CODE NUMBER	SIZE / WEIGHT	ORDERING INFORMATION
Underground Junction Box HDPE Body & Lid 	6-63-06 5000653	13 3/4" x 23 1/4" Opening	CHANNELL BULK215N07204
Pedestal - Metering Pedestal - Base (for above pedestal) Pedestal - Metered	6-63-10 5000654 6-63-12 5000655 6-63-14 5000656	 200 AMP 240/480 V	Dwg L2-209-01 Dwg L2-209-01 Dwg L2s-235
Fault Indicator  Test Tool 	6-66-10 5000657 6-66-20 5000658 6-66-30 5000659	100 Amp Adaptive trip LED, 4 hour reset Test & Reset Tool Lithium Battery	FP 1548FH-BNC3-L- N-A-1 FP AT2186-10 ABB A615-REP

DESCRIPTION OF ITEM	DEPT. CODE NUMBER	SIZE / WEIGHT	ORDERING INFORMATION
<p>Distribution Overhead</p> <p>Horstmann Fault Indicator</p> 	<p>6-66-50 5022891</p>	<p>100 Amp Adaptive Trip LED, 4 hour reset Single Flash</p>	<p>REXEL 41-2001-301</p>
<p>Horstmann Test Tool</p> 	<p>6-66-60 5022912</p>	<p>Test & Reset Tool</p>	<p>49-6001-002</p>
<p>Horstmann Battery</p>	<p>6-66-70 5022915</p>	<p>Lithium-Ion Battery</p>	<p>REXEL 49-6002-023</p>

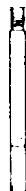

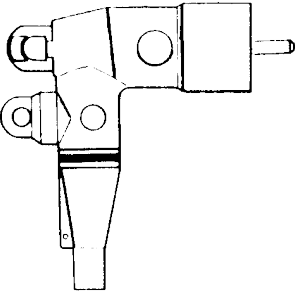
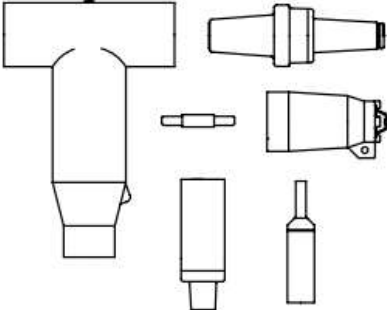
DESCRIPTION OF ITEM	DEPT. CODE NUMBER	SIZE / WEIGHT	ORDERING INFORMATION
<p>Fault Indicator Fits Test Point on Elbow</p>  <p>Fits on Cable</p> 	<p>6-67-01 5001416</p> <p>6-67-02 5001417</p> <p>6-67-03 5000660</p> <p>6-67-04 5021090</p>	<p>200 Amp Elbow 400 Amp Trip</p> <p>600 Amp Elbow 800 Amp Trip</p> <p>800 Amp Trip</p> <p>400 Amp Trip</p>	<p>ELMD TPMVF-LT CP STLO</p> <p>ELMD TPMVF-HT CP STHI</p> <p>CP SDHI-4 (Cooper Only)</p> <p>CP SDLO-4 (Cooper Only)</p>
<p>Fibre Optic Display for Fault Indicator</p> <p>Internal Fault Detector</p> 	<p>6-67-05 5021115</p> <p>6-68-01 5000661</p>	<p>6' Cable</p> <p>c/w 5 PSI Pressure</p>	<p>FP FO-CABLE 06</p> <p>IFD IFD-PT-5PSI-R5- BLK</p>
<p>Elbow Probe</p> 	<p>6-69-01 5001418</p> <p>6-69-03 5000662</p>	<p>200 Amp 15 KV</p> <p>200 Amp 25 KV</p>	<p>ELMD 165LRFR RTE 2637552-C-03</p> <p>ELMD 274 LRF</p>

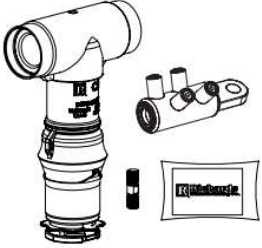
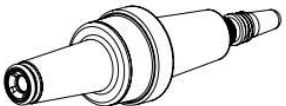
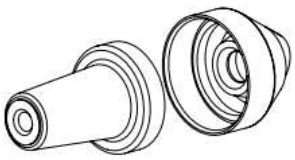

DESCRIPTION OF ITEM	DEPT. CODE NUMBER	SIZE / WEIGHT	ORDERING INFORMATION
<p>Elbow Stud Long W/Blunt Start Threads For 600A T-Body & Bushing</p> <p>Elbow Connector</p> 	<p>6-69-05 5000663</p> <p>6-69-10 5001419</p>	<p>600A T-Body</p> <p>#1 STR 200 AMP 15/25 KV</p>	<p>CP Stud T</p> <p>ELMD 02500230 RTE 2639043-A-05</p>
<p>Elbow 200 Amp</p> 	<p>6-70-04 5000664</p> <p>6-70-05 5001420</p> <p>6-70-07 5001421</p>	<p>200 AMP 25 KV #1 STR. Posi-break</p> <p>200 AMP 15KV 2/0 5 KV XLPE</p> <p>200 AMP 15 KV #1 STR UD Cable</p>	<p>CP PLE 225D05T0</p> <p>ELMD 166LRR-FA-250 RTE2604600-B-05-2/0</p> <p>ELMD 166LR-B-5230 RTE LE215A05T</p>
<p>Elbow 600 Amp c/w Copper Compatible Connector</p> 	<p>6-70-12 5001424</p> <p>6-70-15 5022717</p> <p>6-70-20 5001425</p>	<p>15 KV 250 MCM</p> <p>15 KV 500 MCM</p> <p>5 KV 500 MCM</p>	<p>T&B 656 LRTP-J-0280-DRG 3M 62LCT2H13AC-JB</p> <p>T&B 656LRTP-K-0330-DRG 3M62LCT2K18AD-JB</p> <p>T&B 656 LRTP-H-0330-DRG 3M 62LCT2H18AC-SLP-JB</p>

DESCRIPTION OF ITEM	DEPT. CODE NUMBER	SIZE / WEIGHT	ORDERING INFORMATION
<p>Elbow 600 Amp Cold Shrink T-Body Kit</p>  <p>Kit Components T-Body, 15/16" Threaded Shear-Bolt Lug, Stud, Silica Gel</p> <p>LRTP & Cap OR Insulating Plug & Cap are separate from T-Body Kit</p>	<p>6-70-50 5000665</p> <p>6-70-55 5000666</p>	<p>15 KV #1AWG (6-70-40) 15 KV 250 MCM (6-70-12)</p> <p>5 KV 500 MCM (6-70-20) 15 KV 500 MCM (6-70-15) 15 KV 750 MCM (6-70-17) 25 KV 350 MCM (6-70-09) 25 KV 500 MCM (6-70-08)</p>	<p>RICHARDS/3M 62CSHT1OR1-15/16-JB</p> <p>RICHARDS/3M 62CSHT1PR4-15/16-JB</p>
<p>LRTP 200 Amp 15/16" Threaded</p>  <p>Protective Cap is not included and needs to be ordered separately</p> <p>Will only fit onto T-Bodies that are equipped with 15/16" lugs</p>	<p>**Order 1 LRTP & Cap OR Insulating Plug & Cap per T-Body Kit</p> <p>6-70-60 5001426</p> <p>6-70-65 5001427</p>	<p>15 KV Protective Cap 6-81-00</p> <p>25 KV Protective Cap 6-81-04</p>	<p>3M P615LRTP CP LRTP615 HUB LRTP615 T&B 650LRTPA3</p> <p>3M P625LRTP CP LRTP625 HUB LRTP625 T&B K650LRTPA2</p>
<p>Insulating Plug & Cap Assembly 1 1/16" Non-Threaded</p> 	<p>6-70-70 5001428</p>	<p>15 - 25 KV</p>	<p>3M 625HIP CP DIP625A HUB 625BIP T&B K650BIP</p>

DESCRIPTION OF ITEM	DEPT. CODE NUMBER	SIZE / WEIGHT	ORDERING INFORMATION
<p>Compression Lug</p> 	<p>6-71-01 5000667</p> <p>6-71-05 5000668</p> <p>6-71-06 5000669</p> <p>6-71-07 5000670</p>	<p>#1AWG 11/16" Non- Threaded Bimetal</p> <p>250 MCM 15/16" Non- Threaded Bimetal</p> <p>500 MCM 15/16" Non- Threaded Bimetal</p> <p>750 MCM 15/16" Non- Threaded Bimetal</p>	<p>RICHARDS/3M P7ALCU-08</p> <p>RICHARDS/3M P7ALCU-13-15/16</p> <p>RICHARDS/3M P7ALCU-18-15/16</p> <p>RICHARDS/3M P7ALCU-23-15/16</p>
<p>Bushing Well Insert</p>  <p>Feed Y-Bushing</p> 	<p>6-72-00 5001429</p> <p>6-72-02 5001430</p> <p>6-72-03 5001431</p> <p>6-72-04 5001432</p>	<p>200 Amp 15 KV</p> <p>200 Amp 25 KV</p> <p>200 Amp 15 KV</p> <p>200 Amp 25 KV</p>	<p>ELMD 1601A4 RTE LBI215X</p> <p>ELMD 2701A4 RTE LBI225X</p> <p>ELMD 1602A3 RTE 2637869C01</p> <p>ELMD 2702A1 RTE 2637881-C01MC</p>
<p>Bushing Well Insert - Fused use 7-51-20 fuse</p> <p>fuse holder 200 amp bushing use with 7-51-21 fuse</p>	<p>6-72-06 5000671</p> <p>6-72-08 5000672</p>	<p>15 KV</p> <p>25 KV</p>	<p>ELMD FH15</p> <p>ELMD FH27</p>

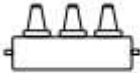
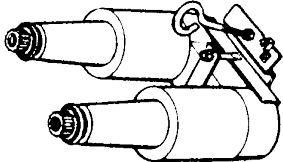

DESCRIPTION OF ITEM	DEPT. CODE NUMBER	SIZE / WEIGHT	ORDERING INFORMATION
Bushing Adapter 600 to 200 Amp 	6-72-15 5001433 6-72-25 5000673	15 KV 25 KV	ELMD 655-BEA-3 CP DBA615
Bushing Extender	6-72-30 5000674	25 KV 600 Amp Use with 6-72-02	ELMD K655BE
Feed-Through c/w Universal Mount 15 KV 200 Amp 25 KV 200 Amp	6-74-13 5001434 6-74-14 5001435 6-74-23 5001436	3 Position 4 Position 3 Position	ELMD 164J3 CP LJ215C3B NO SUBS ELMD 164J4 RTE 2637172B03M NO SUBS ELMD 271J3 RTE 2637160B02MC NO SUBS

DESCRIPTION OF ITEM	DEPT. CODE NUMBER	SIZE / WEIGHT	ORDERING INFORMATION
<p>Feed-Through c/w Universal Mount 15/25 KV 600 Amp</p> 	<p>6-74-32 5001437</p> <p>6-74-33 5001438</p> <p>6-74-34 5001439</p>	<p>2 Position</p> <p>3 Position</p> <p>4 Position</p>	<p>RIC 625JD62B ELMD 650J2-U</p> <p>RIC 625JD63B ELMD K650J3-U</p> <p>RIC 625JD64B ELMD 650J4-U</p>
<p>Feed Through Connectors c/w U-Straps 15/25 KV Compatible with 6-77-05</p>  	<p>6-75-01 5000675</p> <p>6-75-03 5000676</p> <p>6-75-05 5000677</p>	<p>1 200 A Well, 2 600 A Bushings</p> <p>3 200 A Well</p> <p>3 600 A Bushings</p>	<p>Eaton JBI25C1W2BU</p> <p>Eaton LJ215C3U</p> <p>Eaton DJ625C3U</p>
<p>Portable Feed-Through</p> 	<p>6-76-01 5001440</p> <p>6-76-02 5001441</p>	<p>2 Position 200 Amp 15 KV</p> <p>2 Position 200 Amp 25 KV</p>	<p>CP LPF215H ELMD 164FT</p> <p>CP LPF225U ELMD 274FT</p>

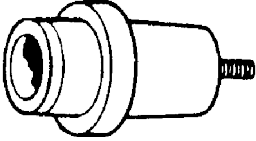
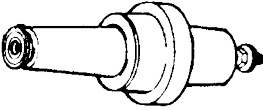
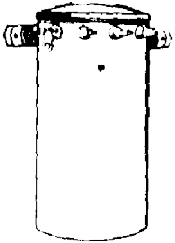

DESCRIPTION OF ITEM	DEPT. CODE NUMBER	SIZE / WEIGHT	ORDERING INFORMATION
<p>Cabinet for Mounting Feed Through Connectors</p> 	<p>6-77-05 5000678</p>	<p>3 Position Compatible with: 6-75-01 & 6-75-05</p>	<p>Eaton SEC34823F0000MGG</p>
<p>Base Fiberglass for Feed Through Connector Cabinet</p>	<p>6-77-10 5000679</p>		<p>GS304822</p>
<p>Standoff Bushing</p> 	<p>6-78-01 5001442</p> <p>6-78-03 5001443</p> <p>6-78-05 5001444</p>	<p>200 Amp 15 KV</p> <p>600 Amp 15 KV or 25 KV</p> <p>200 Amp 25 KV</p>	<p>ELMD 161S0P CP ISB215</p> <p>ELMD K650S0P RTE 2604791B01</p> <p>ELMD 272S0P RTE 2625064B01-MC</p>

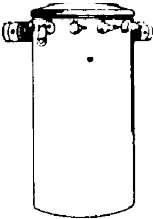
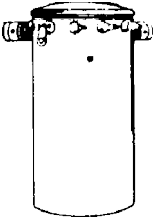
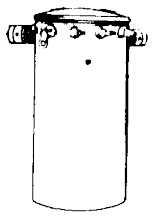

DESCRIPTION OF ITEM	DEPT. CODE NUMBER	SIZE / WEIGHT	ORDERING INFORMATION
<p>Fused Elbow 200 Amp 15 KV</p> 	<p>6-79-01 5000680</p> <p>6-79-03 5000681</p>	<p>#1 - 15 KV CN 3 - 45 Amp Fuse</p> <p>#1 - 15 KV CN 65 - 80 Amp Fuse</p>	<p>ELMD 168FLR1-B0230</p> <p>ELMD 168FLR3-B0230</p>
<p>Arrestor Elbow 200 Amp</p> 	<p>6-79-11 5001445</p> <p>6-79-12 5001446</p>	<p>15 KV</p> <p>25 KV</p>	<p>ELMD 167ESA-10 RTE 323811C10M</p> <p>ELMD 273ESA-18 RTE 3238019C18M</p>
<p>Protective Cap</p> 	<p>6-81-00 5001447</p> <p>6-81-02 5001448</p> <p>6-81-04 5001449</p>	<p>200 Amp 15 KV</p> <p>600 Amp 15 KV or 25 KV</p> <p>200 Amp 25 KV Posi-break</p>	<p>CP LPC215 HUB 215ICI T&B 160DRG 3M 21LBICG</p> <p>CP 2625041A01 ELMD 656 DR</p> <p>CP PLPC225 HUB 9U01BEW500 T&B 273DRG 3M 22LBICG</p>

DESCRIPTION OF ITEM	DEPT. CODE NUMBER	SIZE / WEIGHT	ORDERING INFORMATION
Bushing Well 	6-84-01 5000682	200 Amp 15 KV or 25 KV	ELMD K1601PCC
One Piece Bushing with Clamping Plate 	6-85-03 5000683	600 Amp 15 KV or 25 KV	RTE Body-2637019B04 Clamp-2637023B01 Gasket-0501517A20 Stud-2638100B03
Single Phase Overhead Distribution Transformer 2400 - 120/240 	6-90-05 5000684 6-90-07 5000685 6-90-10 5000686 6-90-16 5000687	50 KVA 75 KVA 100 KVA 167 KVA	Spec 1100 & Addendum Spec 1100 & Addendum Spec 1100 & Addendum Spec 1100 & Addendum

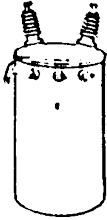
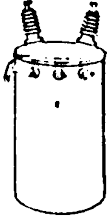
DESCRIPTION OF ITEM	DEPT. CODE NUMBER	SIZE / WEIGHT	ORDERING INFORMATION
<p>Single Phase Overhead Distribution Transformer 4160 - 347</p> 	<p>6-90-33 5000688</p>	<p>333 KVA SPECIAL ORDER</p>	<p>Spec 1100 & Addendum PARKTOWN HOTEL</p>
<p>Single Phase Overhead Distribution Transformer 2 HV Bushings 14.4 KV - 120/240</p> 	<p>6-91-05 5000689</p> <p>6-91-07 5000690</p> <p>6-91-10 5000691</p> <p>6-91-16 5000692</p>	<p>50 KVA</p> <p>75 KVA</p> <p>100 KVA</p> <p>167 KVA</p>	<p>Spec 1100 & Addendum</p> <p>Spec 1100 & Addendum</p> <p>Spec 1100 & Addendum</p> <p>Spec 1100 & Addendum</p>
<p>Single Phase Overhead Distribution Transformer Single HV Bushing 14.4 KV - 120/240</p> 	<p>6-91-25 5000693</p> <p>6-91-27 5000694</p> <p>6-91-30 5000695</p> <p>6-91-31 5000696</p>	<p>50 KVA</p> <p>75 KVA</p> <p>100 KVA</p> <p>167 KVA</p>	<p>Spec 1100 & Addendum</p> <p>Spec 1100 & Addendum</p> <p>Spec 1100 & Addendum</p> <p>Spec 1100 & Addendum</p>



DESCRIPTION OF ITEM	DEPT. CODE NUMBER	SIZE / WEIGHT	ORDERING INFORMATION
<p>Three Phase Overhead Distribution Transformer 4160 - 240</p> 	<p>6-92-07 5000697</p> <p>6-92-15 5000699</p> <p>6-92-22 5000700</p>	<p>75 KVA</p> <p>150 KVA</p> <p>225 KVA</p>	<p>Spec 1101 & Addendum</p> <p>Spec 1101 & Addendum</p> <p>Spec 1101 & Addendum</p>
<p>Three Phase Overhead Distribution Transformer 4160 - 120/208</p> 	<p>6-93-07 5000701</p> <p>6-93-11 5000702</p> <p>6-93-15 5000703</p> <p>6-93-22 5000704</p>	<p>75 KVA</p> <p>112 KVA</p> <p>150 KVA</p> <p>225 KVA</p>	<p>Spec 1101 & Addendum</p> <p>Spec 1101 & Addendum</p> <p>Spec 1101 & Addendum</p> <p>Spec 1101 & Addendum</p>
<p>Three Phase Overhead Distribution Transformer 4160 - 347/600</p> 	<p>6-94-11 5000705</p> <p>6-94-15 5000706</p> <p>6-94-22 5000707</p>	<p>112 KVA</p> <p>150 KVA</p> <p>225 KVA</p>	<p>Spec 1101 & Addendum</p> <p>Spec 1101 & Addendum</p> <p>Spec 1101 & Addendum</p>

DESCRIPTION OF ITEM	DEPT. CODE NUMBER	SIZE / WEIGHT	ORDERING INFORMATION
<p>Three Phase Overhead Distribution Transformer 14.4 KV - 120/208</p> 	<p>6-95-07 5000708</p> <p>6-95-11 5000709</p> <p>6-95-15 5000710</p> <p>6-95-22 5000711</p>	<p>75 KVA</p> <p>112 KVA</p> <p>150 KVA</p> <p>225 KVA</p>	<p>Spec 1101 & Addendum</p> <p>Spec 1101 & Addendum</p> <p>Spec 1101 & Addendum</p> <p>Spec 1101 & Addendum</p>
<p>Three Phase Overhead Distribution Transformer 14.4 KV - 347/600</p> 	<p>6-96-11 5000712</p> <p>6-96-15 5000713</p> <p>6-96-22 5000714</p>	<p>112 KVA</p> <p>150 KVA</p> <p>225 KVA</p>	<p>Spec 1101 & Addendum</p> <p>Spec 1101 & Addendum</p> <p>Spec 1101 & Addendum</p>
<p>Single Phase Overhead Distribution Transformer Single HV Bushing 8320 - 120/240</p> 	<p>6-97-05 5001450</p> <p>6-97-07 5000716</p> <p>6-97-10 5000717</p> <p>6-97-12 5000718</p>	<p>50 KVA</p> <p>75 KVA</p> <p>100 KVA</p> <p>167 KVA</p>	<p>Spec 1100 & Addendum</p> <p>Spec 1100 & Addendum</p> <p>Specification 1 & Addendum</p> <p>Spec 1100 & Addendum</p>

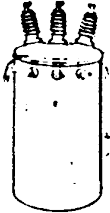
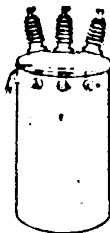
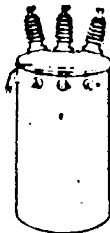
DESCRIPTION OF ITEM	DEPT. CODE NUMBER	SIZE / WEIGHT	ORDERING INFORMATION
<p>Single Phase Overhead Distribution Transformer Single HV Bushing 8320 - 240/480</p> 	<p>6-97-15 5000719</p>	<p>50 KVA</p>	<p>Spec 1100 & Addendum</p>
<p>Single Phase Overhead Distribution Transformer 2 HV Bushings 8320 - 120/240</p> 	<p>6-97-25 5000720</p> <p>6-97-27 5000721</p>	<p>50 KVA</p> <p>75 KVA</p>	<p>Spec 1100 & Addendum</p> <p>Spec 1100 & Addendum</p>
<p>Three Phase Overhead Distribution Transformer 14.4 KV - 240</p> 	<p>6-98-04 5017894</p> <p>6-98-07 5001498</p> <p>6-98-09 5000722</p>	<p>45 KVA</p> <p>75 KVA</p> <p>112 KVA</p>	<p>Spec 1101 & Addendum</p> <p>Spec 1101 & Addendum</p> <p>Spec 1101 & Addendum</p>

DESCRIPTION OF ITEM	DEPT. CODE NUMBER	SIZE / WEIGHT	ORDERING INFORMATION
<p>Three Phase Overhead Distribution Transformer 24940 - 240</p> 	<p>6-98-17 5000723</p> <p>6-98-25 5000724</p>	<p>75 KVA</p> <p>150 KVA</p>	<p>Spec 1101 & Addendum</p> <p>Spec 1101 & Addendum</p>
<p>Three Phase Overhead Distribution Transformer 24940 - 120/208</p> 	<p>6-98-27 5000725</p> <p>6-98-31 5000726</p> <p>6-98-35 5000727</p> <p>6-98-42 5000728</p>	<p>75 KVA</p> <p>112 KVA</p> <p>150 KVA</p> <p>225 KVA</p>	<p>Spec 1101 & Addendum</p> <p>Spec 1101 & Addendum</p> <p>Spec 1101 & Addendum</p> <p>Spec 1101 & Addendum</p>
<p>Three Phase Overhead Distribution Transformer 24940 - 347/600</p> 	<p>6-98-51 5000729</p> <p>6-98-62 5000730</p>	<p>112 KVA</p> <p>225 KVA</p>	<p>Spec 1101 & Addendum</p> <p>Spec 1101 & Addendum</p>

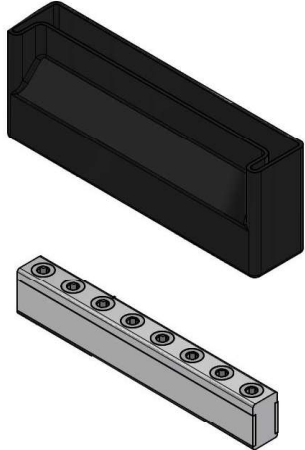
DESCRIPTION OF ITEM	DEPT. CODE NUMBER	SIZE / WEIGHT	ORDERING INFORMATION
Three Phase Network Transformer 14700 - 347/600	6-99-01 5025525	2000 KVA	Spec 4102

DESCRIPTION OF ITEM	DEPT. CODE NUMBER	SIZE	ORDERING INFORMATION
<p>Cookie Terminal Strips and Covers</p> 	<p>7-00-10 5023035</p>		<p>ILSCO N8247AQ2T</p>
<p>Insulated Roll-On Splice Cover For UG #2-2/0</p> 	<p>7-00-20 5023009</p>		<p>Raychem RVS-11(B50)</p>
<p>Secondary Terminal Block</p> <p>Rubber Sleeve</p>	<p>7-04-20 5000731</p> <p>7-04-30 5000732</p>	<p>6 Position C/W Cover</p>	<p>HOM FS6-125</p> <p>CP CSN-2011</p>

DESCRIPTION OF ITEM	DEPT. CODE NUMBER	SIZE	ORDERING INFORMATION
Transformer Bushing Primary Voltage	7-05-06 5000733 7-05-20 5000734	14.4 KV 25 KV	FER-P B101024180 WEST Dwg. POB DL25A
SMU-40 Fuse Unit Standard 	7-41-40 5000735	200 AMP 15 KV 25,000 Interrupting	S&C SMU-40-144 No Subs
EE1-Nema Universal Screw 23" Button Link Type "K" Fast 	7-42-06 5001451 7-42-08 5001452 7-42-10 5001453 7-42-12 5001454	6 Amp 8 Amp 10 Amp 12 Amp	AB M6KA23 CP FL3K6 KRN 31006 AB M8KA23 CP FL3K8 KRN 31008 AB M10KA23 CP FL3K10 KRN 31010 AB M12KA23 CP FL3K12 KRN 31012

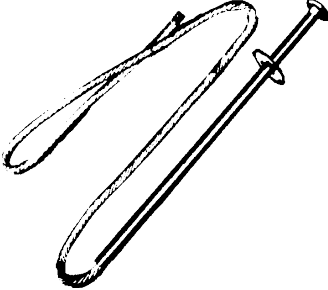
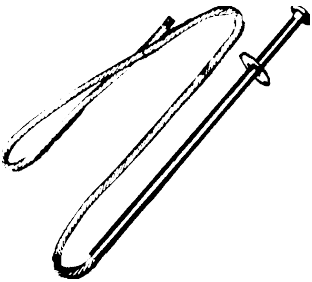
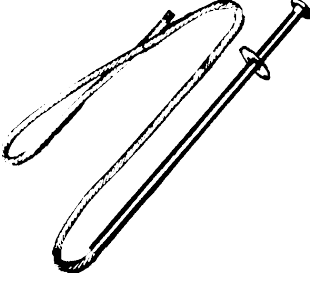
DESCRIPTION OF ITEM	DEPT. CODE NUMBER	SIZE	ORDERING INFORMATION
EE1-Nema Universal Screw 23" Button Link Type "K" Fast 	7-42-15 5001455	15 Amp	AB M15KA23 CP FL3K15 KRN 31015
	7-42-20 5001456	20 Amp	AB M20KA23 CP FL3K20 KRN 31020
	7-42-25 5001457	25 Amp	AB M25KA23 CP FL3K25 KRN 31025
	7-42-30 5001458	30 Amp	AB M30KA23 CP FL3K30 KRN 31030
EE1-Nema Universal Screw 23" Button Link Type "K" Fast 	7-42-40 5001459	40 Amp	AB M40KA23 CP FL3K40 KRN 31040
	7-42-50 5001460	50 Amp	AB M50KA23 CP FL3K50 KRN 31050
	7-42-65 5001461	65 Amp	AB M65KA23 CP FL3K65 KRN 31065
	7-42-80 5001462	80 Amp	AB M80KA23 CP FL3K80 KRN 31080
EE1-Nema Universal Screw 23" Button Link Type "K" Fast 	7-42-81 5001463	100 Amp	AB M100KA23 CP FL3K100 KRN 31100
	7-42-83 5001464	140 Amp	AB M140KA23 CP FL3K140 KRN 31140
	7-42-85 5001465	200 Amp	AB M200KA23 CP FL3K200 KRN 31200

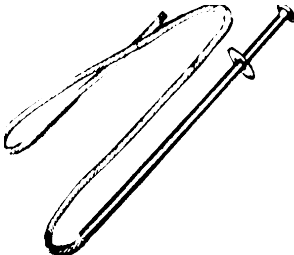
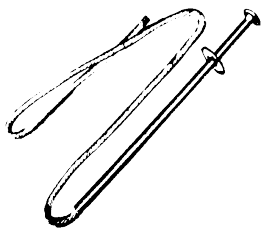
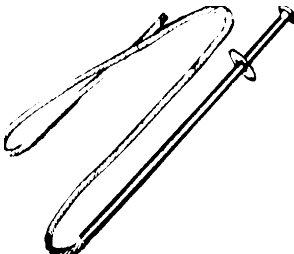

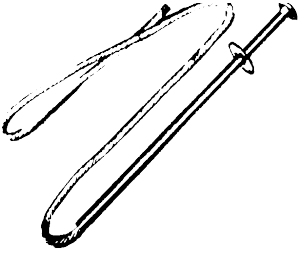
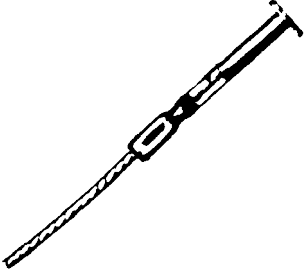
DESCRIPTION OF ITEM	DEPT. CODE NUMBER	SIZE	ORDERING INFORMATION
<p>EE1-Nema Universal Screw 23" Button Link Type "T" Slow</p> 	<p>7-43-06 5001466</p> <p>7-43-08 5001467</p> <p>7-43-12 5001468</p> <p>7-43-15 5001469</p>	<p>6 Amp</p> <p>8 Amp</p> <p>12 Amp</p> <p>15 Amp</p>	<p>AB M6TA23 CP FL3T6 KRN 51006</p> <p>AB M8TA23 CP FL3T8 KRN 51008</p> <p>AB M12TA23 CP FL3T12 KRN 51012</p> <p>AB M15TA23 CP FL3T15 KRN 51015</p>
<p>EE1-Nema Universal Screw 23" Button Link Type "T" Slow</p> 	<p>7-43-20 5001470</p> <p>7-43-25 5001471</p> <p>7-43-30 5001472</p> <p>7-43-40 5001473</p>	<p>20 Amp</p> <p>25 Amp</p> <p>30 Amp</p> <p>40 Amp</p>	<p>AB M20TA23 CP FL3T20 KRN 51020</p> <p>AB M25TA23 CP FL3T25 KRN 51025</p> <p>AB M30TA23 CP FL3T30 KRN 51030</p> <p>AB M40TA23 CP FL3T40 KRN 51040</p>
<p>EE1-Nema Universal Screw 23" Button Link Type "T" Slow</p> 	<p>7-43-50 5001474</p> <p>7-43-65 5001475</p> <p>7-43-80 5001476</p> <p>7-43-81 5001477</p>	<p>50 Amp</p> <p>65 Amp</p> <p>80 Amp</p> <p>100 Amp</p>	<p>AB M50TA23 CP FL3T50 KRN 51050</p> <p>AB M65TA23 CP FL3T65 KRN 51065</p> <p>AB M80TA23 CP FL3T80 KRN 51080</p> <p>AB M100TA23 CP FL3T100 KRN 51100</p>

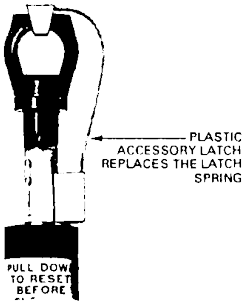

DESCRIPTION OF ITEM	DEPT. CODE NUMBER	SIZE	ORDERING INFORMATION
EE1-Nema High Surge 23" Button Link Type "H" 	7-45-01 5000736 7-45-02 5000737 7-45-03 5000738 7-45-05 5000739	1 Amp 2 Amp 3 Amp 5 Amp	CP FL3H1 CP FL3H2 CP FL3H3 CP FL3H5
Distribution Fuse Link Type "X" 	7-46-67 5000740 7-46-68 5000741 7-46-76 5000742	250X Amp 7.5 KV 300X Amp 7.5 KV 200X Amp 15 KV	PUR UAX 75250 PUR UAX 75300 PUR SX 15200
Distribution Fuse Link Type "F"	7-46-87 5000743 7-46-88 5000744 7-46-98 5000745	250F Amp 7.5 KV 300F Amp 7.5 KV 300F Amp 15 KV	PUR UAF 75250 PUR UAF 75300 PUR UAF 15300

DESCRIPTION OF ITEM	DEPT. CODE NUMBER	SIZE	ORDERING INFORMATION
Padmount Fuse Unit 8 KV	7-47-12 5000746 7-47-15 5000747 7-47-20 5000748 7-47-25 5000749	12K Amp 15K Amp 20K Amp 25K Amp	S&C 511012R1 S&C 511015R1 S&C 511020R1 S&C 511025R1
Padmount Fuse Unit 8 KV	7-47-30 5000750 7-47-40 5000751 7-47-50 5000752	30K Amp 40K Amp 50K Amp	S&C 511030R1 S&C 511040R1 S&C 511050R1
Plastic Latch 	7-48-01 5000753	For NX Hinged Fuses 7-48-xx	CP FM2E1C

DESCRIPTION OF ITEM	DEPT. CODE NUMBER	SIZE	ORDERING INFORMATION
Indoor Current Limiting Fuse Type NX - 4.3 KV 	7-48-12 5000754 7-48-18 5000755 7-48-25 5000756 7-48-35 5000757	12 Amp 18 Amp 25 Amp 35 Amp	CP FA2A12 CP FA27A18 CP FA27A25 CP FA27A35
Indoor Current Limiting Fuse Type NX - 4.3 KV 	7-48-50 5000758 7-48-75 5000759 7-48-81 5000760	50 Amp 75 Amp 100 Amp	CP FA27A50 CP FA27A75 CP FA27A100
Indoor Current Limiting Fuse Type NX - 15.5 KV	7-49-12 5000761 7-49-18 5000762 7-49-25 5000763 7-49-40 5000764	12 Amp 18 Amp 25 Amp 40 Amp	CP FA30A12 CP FA30A18 CP FA30A25 CP FA30A40



DESCRIPTION OF ITEM	DEPT. CODE NUMBER	SIZE	ORDERING INFORMATION
<p>Outdoor Current Limiting Fuse 8.3 KV</p> 	<p>7-49-43 5000765</p> <p>7-49-45 5000766</p>	<p>25 Amp</p> <p>40 Amp</p>	<p>Specification 1 AB K-Mate-25 C70L31KABO</p> <p>Specification 1 AB K-Mate-40 C70L21KABO</p>
<p>Indoor Loadbreak Switchblade Type NX - 8.3 KV</p> 	<p>7-49-50 5000767</p>	<p>200 Amp</p>	<p>CP FA7B1 CP FA1B1</p>
<p>Fuse Holder for Wet Well Assembly Side Wall Mounted</p>  <p>Fuse Cartridge With End Plug</p>	<p>7-49-56 5000768</p> <p>7-49-58 5000769</p>	<p>14.4 KV</p> <p>14.4 KV</p>	<p>RTE 4001030B52M</p> <p>RTE 4001686-A-53</p>

DESCRIPTION OF ITEM	DEPT. CODE NUMBER	SIZE	ORDERING INFORMATION
Padmount Bayonet Fuse Dual Sensing 	7-49-60 500770 7-49-61 500771 7-49-62 500772	8 Amp 15 Amp 25 Amp	RTE 4000358C05 RTE 4000358C08 RTE 4000358C10
Padmount Bayonet Fuse Current Sensing 	7-49-65 500773 7-49-66 500774 7-49-67 500775 7-49-68 500776	40 Amp 65 Amp 100 Amp 140 Amp	RTE 4000353C12 RTE 4000353C14 RTE 4000353C16 RTE 4000353C17
Padmount Oil Immersible Bayonet Fuse 15.5 KV Current Limiting Clip Style Current Limiting Back-Up Screw Type Current Limiting Back-Up Clip Style 	7-49-70 500777 7-49-78 500778 7-49-79 500779	8 Amp 100 Amp 100 Amp	RTE 3534008M11 RTE 3544100M51 RTE 3544100M11

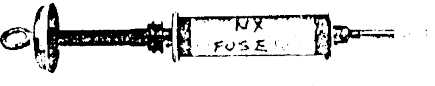
DESCRIPTION OF ITEM	DEPT. CODE NUMBER	SIZE	ORDERING INFORMATION
<p>Padmount Dry Canister Clip Style Fuse Type NX 4.3 KV</p> 	<p>7-49-82 5000780</p> <p>7-49-83 5000781</p>	<p>50 Amp</p> <p>75 Amp</p>	<p>CP FA1H50</p> <p>CP FA1H75</p>
<p>Padmount Dry Canister Clip Style Fuse Type NX 15.5 KV</p> 	<p>7-49-86 5000782</p> <p>7-49-87 5000783</p> <p>7-49-88 5000784</p> <p>7-49-89 5000785</p>	<p>6 Amp</p> <p>8 Amp</p> <p>10 Amp</p> <p>12 Amp</p>	<p>CP FA4H6</p> <p>CP FA4H8</p> <p>CP FA4H10</p> <p>CP FA4H12</p>
<p>Padmount Dry Canister Clip Style Fuse Type NX 15.5 KV</p> 	<p>7-49-91 5000786</p> <p>7-49-92 5000787</p> <p>7-49-93 5000788</p>	<p>18 Amp</p> <p>25 Amp</p> <p>40 Amp</p>	<p>CP FA4H18</p> <p>CP FA4H25</p> <p>CP FA4H40</p>



DESCRIPTION OF ITEM	DEPT. CODE NUMBER	SIZE	ORDERING INFORMATION
Padmount Dry Canister Clip Style Fuse Type CX 15.5 KV 	7-49-95 5000789	8C Amps	CH 5980C19G07
Drywell Canister	7-49-97 5000790	14.4KV	
Current Limiting Fuse Holder for Drywell Canister 	7-49-98 5000791 7-49-99 5000792	14.4 KV 14.4 KV	CGE 7559ZB1099 CGE 7559ZB3199

DESCRIPTION OF ITEM	DEPT. CODE NUMBER	SIZE	ORDERING INFORMATION
Refill Power Fuse Unit Type SM-4 - 7.2 KV	7-50-02 5000793	40E Amp Std	S&C 121060R4
	7-50-04 5000794	50E Amp Std	S&C 121075R4
	7-50-06 5000795	200E Amp Slow	S&C 251300R4
Refill Power Fuse Unit Type SM-4 - 14.4 KV	7-50-07 5000796	100E Amp Std	S&C 122150R4
	7-50-08 5000797	200E Amp Std	S&C 122300R4
Refill Power Fuse Unit Type SM-5 - 14.4 KV 	7-50-12 5000798	80E Amp Std	S&C 132125R4
	7-50-16 5000799	125E Amp Slow	S&C 262200R4
	7-50-18 5000800	200E Amp Slow	S&C 262300R4
	7-50-20 5000801	400E Amp Std	S&C 132600R4



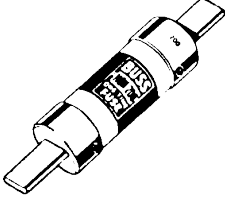

DESCRIPTION OF ITEM	DEPT. CODE NUMBER	SIZE	ORDERING INFORMATION
Power Fuse Barrel Type Sm-4 - Outdoor (Without snuffler) 	7-50-40 5000802	200E Amp 7.2 KV	S&C 86051
Type SM-4S - Indoor (With snuffler)	7-50-41 5000803	200E Amp 7.2 KV	S&C 86631R1
Power Fuse Type RBA-ROB-400	7-50-50 5000804	250E Amps 15 KV	WEST 423D815A44
Switching Cubicle Fuse 	7-51-01 5000805	8.3 KV 200 Amp Current Limiting c/w cartridge	RTE 3437851B01M
	7-51-05 5000806	25 KV SLC-90 Current Limiting	AB C705-0424
	7-51-07 5000807	25 KV SLE-90 Oil Expulsion	AB E553-3651
	7-51-09 5000808	25 KV 95A 65E ELSG	RTE 3595065M02M

DESCRIPTION OF ITEM	DEPT. CODE NUMBER	SIZE	ORDERING INFORMATION
<p>Elbow Fuse 8.3 KV</p> <p>** For in field replacement only Not compatible with current 6-79-01</p> <p>** For in field replacement only Not compatible with current 6-79-01</p>	<p>7-51-11 5000809</p> <p>7-51-12 ** 5000810</p> <p>7-51-13 5000811</p> <p>7-51-15 ** 5000812</p> <p>7-51-16 5000813</p> <p>7-51-17 5000814</p> <p>7-51-18 5000815</p>	<p>8 Amp (use with 6-79-01)</p> <p>8 Amp</p> <p>30 Amp (use with 6-79-01)</p> <p>30 Amp</p> <p>45 Amp (use with 6-79-01)</p> <p>65 Amp (use with 6-79-03)</p> <p>80 Amp (use w 6-79-03)</p>	<p>ELMD EFX 083 008-E</p> <p>JOS PF8-8</p> <p>ELMD EFX 083 030-E</p> <p>JOS PF8-30</p> <p>ELMD EFX 083 045-E</p> <p>ELMD EFX 083 065-E</p> <p>ELMD EFX 083 080-E</p>
<p>SF6 Power Fuse</p> <p>Joslyn Switching Cubicle 1132-S (use with 6-72-06)</p> <p>Joslyn Switching Cubicle 1101-S (use with 6-72-08)</p>	<p>7-51-20 5000816</p> <p>7-51-21 5000817</p> <p>7-51-30 5000818</p>	<p>100 Amp 15 KV</p> <p>140 Amp 15 KV</p> <p>65 Amp 25 KV</p>	<p>ELMD F100K-15</p> <p>JOS F140K-15</p> <p>ELMD F65K27</p>
<p>Plug Fuse - 120 Volt</p> 	<p>7-52-06 5000819</p> <p>7-52-10 5000820</p> <p>7-52-20 5000821</p> <p>7-52-30 5000822</p>	<p>6 Amp</p> <p>10 Amp</p> <p>20 Amp</p> <p>30 Amp</p>	<p>BUSS W-6 (No Subs)</p> <p>BUSS W-10 (No Subs)</p> <p>GLD GP-20 (No Subs)</p> <p>GLD GP-30 (No Subs)</p>

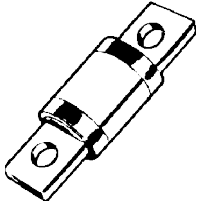
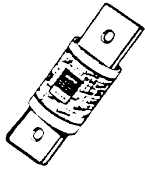

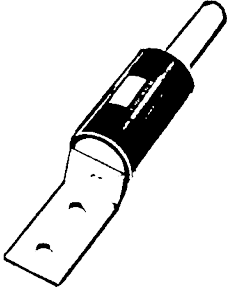

DESCRIPTION OF ITEM	DEPT. CODE NUMBER	SIZE	ORDERING INFORMATION
<p>One Time Fuse - 250 Volt, 10 KA Class H Ferrule Type</p> 	<p>7-53-10 5000823</p> <p>7-53-15 5000824</p> <p>7-53-20 5000825</p> <p>7-53-30 5000826</p> <p>7-53-50 5000827</p> <p>7-53-60 5000828</p>	<p>10 Amp</p> <p>15 Amp</p> <p>20 Amp</p> <p>30 Amp</p> <p>50 Amp</p> <p>60 Amp</p>	<p>NRN 10</p> <p>NRN 15</p> <p>NRN 20</p> <p>NRN 30</p> <p>NRN 50</p> <p>NRN 60</p>
<p>Mini Fuse One Time - 600 Volt, 100 KA Ferrule Type For 120V, 240V & 347V Fixtures</p> 	<p>7-53-68 5001478</p> <p>7-53-70 5000829</p> <p>7-53-74 5000831</p> <p>7-53-76 5000833</p>	<p>6 Amp</p> <p>10 Amp</p> <p>20 Amp</p> <p>30 Amp</p>	<p>BUSS KTK-6 MER ATM6</p> <p>BUSS KTK-10 MER ATM10</p> <p>BUSS KTK-20 MER ATM20</p> <p>BUSS KTK-30 MER ATM30</p>
<p>Mini Fuse Neutral Link</p> 	<p>7-53-98 5000835</p>		<p>SHAW MNL30</p>

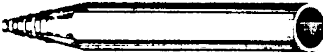

DESCRIPTION OF ITEM	DEPT. CODE NUMBER	SIZE	ORDERING INFORMATION
<p>One Time Fuse - 250 Volt Knife Blade Type</p> 	<p>7-54-07 5000836</p> <p>7-54-10 5000837</p>	<p>70 Amp</p> <p>100 Amp</p>	
<p>PT Fuse</p>  <p>Main St, College Park & Lorne Ave SS</p> <p>Friebel, Taylor & Bunn SS</p> <p>For West PT's at Cowley & Ave C SS For Landfill</p>	<p>7-63-01 5000838</p> <p>7-63-07 5000839</p> <p>7-63-08 5000840</p> <p>7-63-09 5000841</p> <p>7-63-11 5000842</p> <p>7-63-12 5000843</p> <p>7-63-15 5000844</p>	<p>3/10 Amp, 2400 Volt</p> <p>2E Amp, 4800 Volt</p> <p>1/2E Amp, 7200 Volt</p> <p>1/2E Amp, 14400 Volt</p> <p>1E Amp, 14400 Volt</p> <p>1E Amp</p> <p>1/2 Amp, 25 KV</p>	<p>BUSS BNF1</p> <p>GE 328L497G13</p> <p>S&C 271000</p> <p>GE 328L497G19</p> <p>S&C T1265 Brush 15-12CAV1E</p> <p>GE 328L0497G20</p> <p>EATON 25CLPT-.5</p>
<p>Secondary Fuse for Padmount Transformer & Pedestal 600 Volt HRC Form J Type</p>	<p>7-65-15 5000845</p>	<p>150 Amp</p>	<p>EE C150J SHAW A4J150</p>

DESCRIPTION OF ITEM	DEPT. CODE NUMBER	SIZE	ORDERING INFORMATION
Limiter Fuse for Pedestal 	7-65-16 5000847 7-65-17 5000848	150 Amp Old Style - Pre 1990 150 Amp New Style - After 1990	BUR LF1025 BUSS UHW-K
Limiter Fuse For Pedestal Terminal Block	7-65-20 5000849 7-65-22 5000851 7-65-24 5000853	# 2 str. cu 2/0 str. cu 4/0 str. cu	CAB 2CL2BF FER 2CL2BF CAB 2CL20BF FER 2CL20BF CAB 2CL40BF FER 2CL40BF
Current Limiting Fuse HRC Form J 600 Volt 200,000 Amp Interruption 	7-65-40 5000855	400 Amp	EE C400J

DESCRIPTION OF ITEM	DEPT. CODE NUMBER	SIZE	ORDERING INFORMATION
<p>Network Limiter Fuse 600 Volt 200,000 Amp Interruption</p> 	<p>7-65-61 5000856</p> <p>7-65-63 5000857</p> <p>7-65-65 5000858</p>	<p># 2</p> <p>2/0</p> <p>500 MCM</p>	<p>GLD CP2C3</p> <p>GLD CP20C3</p> <p>BUSS TYPE KDM GLD CP500C3</p>
<p>Secondary Network Protector Fuse</p>	<p>7-65-67 5000860</p> <p>7-65-68 5000861</p>	<p>600 Volt 2000 Amp 3 Hole</p> <p>600 Volt 2500 Amp 4 Hole</p>	<p>WEST 1300553</p> <p>WEST 1332318</p>
<p>Network Fuse</p>  <p>In-Line Fuseholder</p>  <p>Waterproof Sleeve</p> 	<p>7-65-70 5000862</p> <p>7-65-71 5000864</p> <p>7-65-72 5000865</p>	<p>600 Volt 30 Amp 200 KA</p> <p>600 Volt 30 Amp 200 KA</p>	<p>BUSS KTKR-30 SHAW ATMR30</p> <p>SHAW FEC-11-11-BA</p> <p>BUSS 1A0512 SHAW FSB1</p>

DESCRIPTION OF ITEM	DEPT. CODE NUMBER	SIZE	ORDERING INFORMATION
Primary Network Limiter Fuse Control Cabinet	7-65-84 500867 7-65-86 500869	1 AMP 200,000 KA 5 AMP 200,000 KA	BUSS KTK GLD ATMR1 BUSS KTK GLD ATMR5
Network Fuse Type MPL	7-66-01 500871	2825 Amp	WEST 140D318G02
Network Limiter Protection Rubber Sleeve 	7-69-00 500872		HOM FS1175 GLD CPB10 part A2576B

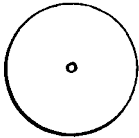
DESCRIPTION OF ITEM	DEPT. CODE NUMBER	SIZE	ORDERING INFORMATION
<p>Tape</p> <p>PVC</p>  <p>Self Amalgamating Polyisobutylene Rotunda Selotape</p> 	<p>7-72-01 5000874</p> <p>7-72-03 5000875</p> <p>7-72-05 5000876</p> <p>7-72-07 5000877</p> <p>7-72-09 5000878</p>	<p>3/4" x 66'</p> <p>3/4" x 66' x .0085" (For Winter Use)</p> <p>2"x36 yards x .0085"</p> <p>1" x 30' Linerless</p> <p>2" x 30'</p>	<p>3M Temflex</p> <p>3M - #88</p> <p>3M #88-2"</p> <p>3M - #130C</p> <p>Scapa 2501-2</p>
<p>Tape</p>  <p>Semi-Conducting</p> <p>Silicon Splicing</p> <p>Busbar Heatshrink Insulation</p>	<p>7-72-16 5000879</p> <p>7-72-20 5000880</p> <p>7-72-38 5000881</p>	<p>3/4"</p> <p>1" x 30'</p> <p>2" x 25'</p>	<p>3M #13 (No Substitutes)</p> <p>3M #70 (No Substitutes)</p> <p>RAY HVBT-2-R</p>
<p>Braid</p> <p>Tinned Copper Tinsel</p>  <p>Flexible</p> 	<p>7-72-40 5000882</p> <p>7-72-42 5000883</p>	<p>5/16"</p> <p>18" Strap</p>	<p>Belden 8663</p> <p>BUR BD18</p>

DESCRIPTION OF ITEM	DEPT. CODE NUMBER	SIZE	ORDERING INFORMATION
Phase Tape Red Yellow Blue White	7-72-60 500884 7-72-61 500885 7-72-62 500886 7-72-63 500887	3/4" x 66' 3/4" x 66' 3/4" x 66' 3/4" x 66'	3M Colourflex-Red 3M Colourflex-Yellow 3M Colourflex-Blue 3M Colourflex-White
Phase Marker Disc Type Red Yellow Blue 	7-72-76 500888 7-72-77 500889 7-72-78 500890		
Omni Marker Balls Red - Power Marker Plate Red - Power 	7-72-80 500891 7-72-82 5018269	Part #160 1251 EMS Full Range	3M 80610221295

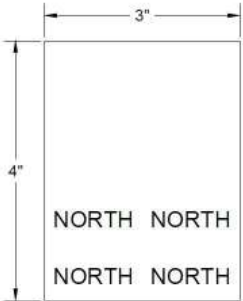
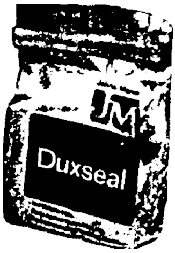
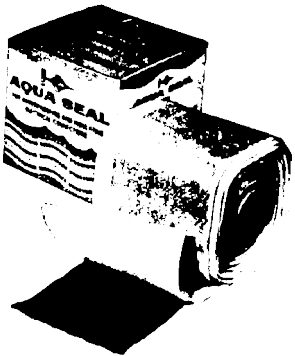

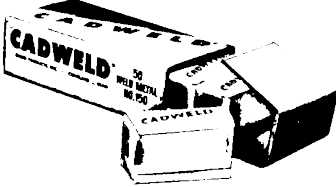
DESCRIPTION OF ITEM	DEPT. CODE NUMBER	SIZE	ORDERING INFORMATION
<p>Cable Tags</p> 	<p>7-72-90 5000892</p> <p>7-72-91 5000893</p> <p>7-72-92 5000894</p> <p>7-72-93 5000895</p>	<p>North</p> <p>South</p> <p>East</p> <p>West</p>	
<p>Duxseal</p> 	<p>7-73-01 5000896</p>	<p>1 lb. Pug</p>	
<p>Aquaseal</p> 	<p>7-73-03 5000897</p>	<p>1/8" x 3 3/4" x 10'</p>	<p>KRN 104742</p>



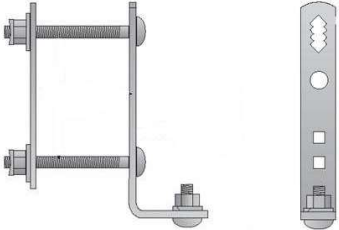
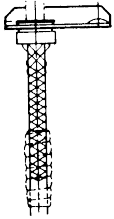

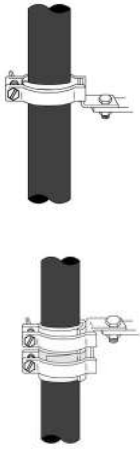
DESCRIPTION OF ITEM	DEPT. CODE NUMBER	SIZE	ORDERING INFORMATION
Cable Prep Kits	7-73-04 5000898	CC2	3M
Cadweld Thermite Cartridge 	7-74-06 5000899 7-74-09 5000900 7-74-11 5000901 7-74-20 5000902	#65 #90 #115 #200	CAD 90PLUSF20 CAD 115PLUSF20 CAD 200PLUSF20
Man Hole Lid Man Hole Frame Man Hole Collar	7-78-01 5000903 7-78-03 5000904 7-78-05 5000905	813mm (32") 813mm (32") 50mm (2")	Dwg. A1s-103 Dwg. A1s-103 Dwg. A1s-103



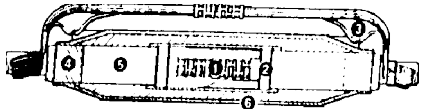

DESCRIPTION OF ITEM	DEPT. CODE NUMBER	SIZE	ORDERING INFORMATION
<p>Stress Cone Kit Indoor</p> 	<p>7-80-13 5000906</p> <p>7-80-17 5000907</p>	<p>15KV-500, 750, 1000 25KV-500</p> <p>1000 MCM - 15 KV XLPE Sh</p>	<p>3M 7655-T-150</p> <p>ELMD 35MSC-KB</p>
<p>Stress Cone Kit - Cold Shrink Indoor</p>	<p>7-80-50 5000908</p>	<p>5KV 700-1500MCM 15KV 500-1000MCM</p>	<p>3M 7645-T-110</p>
<p>Shield Adapter for Cold Shrink Stress Cones Constant Force Springs</p> <p>Use with 7-72-40</p>	<p>7-82-04 5000909</p> <p>7-82-10 5000910</p>	<p>Up to 500 MCM</p> <p>750 MCM and over</p>	<p>3M CFS-0.80/1.50</p> <p>3M CFS-1.50/3.00</p>

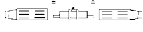
DESCRIPTION OF ITEM	DEPT. CODE NUMBER	SIZE	ORDERING INFORMATION
Stress Cone Kit Cold Shrink Concentric Neutral Outdoor	7-83-15 5000911	5 KV 4/0 - 400 MCM 15 KV #2 - 4/0 25 KV #2 - 1/0	3M 7652-S-4
	7-83-19 5000912	5 KV 500-750 MCM 15 KV 4/0 - 500 MCM 25 KV 2/0 - 250 MCM	3M 7654-S-4
	7-83-21 5000913	15 KV 750 MCM 15 KV 1000 MCM	3M 7655-S-4
Kellems Grip Mounting Bracket 	7-85-02 5000914		CP DM9B1
Cable Hanger Kellems Grip 	7-86-02 5000915	#1 - 15 KV 250 MCM - 15 KV #1 - 25 KV	ELMD 35MTB1-B
	7-86-04 5000916	250 MCM - 15 KV 500 MCM - 15 KV 500 MCM - 5 KV	ELMD 35MTB1-A
	7-86-06 5000917	750 MCM - 15 KV 1000 MCM - 15 KV	ELMD 35MTB1-D

DESCRIPTION OF ITEM	DEPT. CODE NUMBER	SIZE	ORDERING INFORMATION
<p>Cable Hanger Kellems Grip For Substations Only</p> 	<p>7-86-12 5000918</p> <p>7-86-16 5000919</p> <p>7-86-17 5000920</p>	<p>500 MCM - 15 KV Grip Range 1.562"-1.687"</p> <p>750 MCM - 15 KV Grip Range 1.812"-1.937"</p> <p>1000 MCM - 15 KV Grip Range 2.062"-2.187"</p>	<p>HUB 07401034</p> <p>HUB 074011031</p> <p>HUB 074011033</p>
<p>Cable Support Bracket</p> 	<p>7-86-22 5000921</p> <p>7-86-24 5000922</p> <p>7-86-26 5000923</p> <p>7-86-28 5000924</p>	<p>Cable OD Range</p> <p>1.0" - 1.25"</p> <p>1.0" - 1.5"</p> <p>1.5" - 2.0"</p> <p>2.0" - 2.5"</p>	<p>3M MB-3</p> <p>3M MB-4</p> <p>3M MB-5</p> <p>3M MB-6</p>
<p>Hooks for Cable Hangers</p> 	<p>7-86-50 5000925</p> <p>7-86-55 5000927</p>	<p>For Wood Poles</p> <p>For Steel Poles</p>	<p>MAC P J3316P SL 1316</p> <p>MAC P U2398</p>

DESCRIPTION OF ITEM	DEPT. CODE NUMBER	SIZE	ORDERING INFORMATION
<p>Kellems Grip Support for Three Cables Standard</p> 	<p>7-87-01 5000928</p> <p>7-87-02 5000929</p> <p>7-87-03 5000930</p> <p>7-87-04 5000931</p>	<p>3.50 - 3.99" 750 MCM - 15 KV</p> <p>3.00 - 3.49" 500 MCM - 15 KV 500 MCM - 25 KV</p> <p>2.50 - 3.00" 250 MCM - 15 KV</p> <p>2.00 - 2.49" #1 - 15 KV 250 MCM - 5 KV #1 - 25 KV</p>	<p>HUB 022-01-012</p> <p>HUB 022-01-011</p> <p>HUB 022-01-010</p> <p>HUB 022-01-009</p>
<p>Kellems Grip Support for Three Cables Split</p> 	<p>7-87-11 5000932</p> <p>7-87-12 5000933</p> <p>7-87-14 5000934</p>	<p>3.50 - 3.99" 750 MCM - 15 KV</p> <p>3.00 - 3.49" 500 MCM - 15 KV 500 MCM - 25 KV</p> <p>2.00 - 2.49" #1 - 15 KV 250 MCM - 5 KV #1 - 25 KV</p>	<p>HUB 022-03-012</p> <p>HUB 022-03-011</p> <p>HUB 022-03-009</p>
<p>Kellem's Grip Support for Single Eye</p> 	<p>7-87-21 5023011</p> <p>7-87-22 5023032</p> <p>7-87-23 5023023</p>	<p>1" - 1.24"</p> <p>1.25" - 1.49"</p> <p>1.5" - 1.74"</p>	<p>02401041</p> <p>02401042</p> <p>02401043</p>

DESCRIPTION OF ITEM	DEPT. CODE NUMBER	SIZE	ORDERING INFORMATION
<p>Splice Kit - One Piece</p> 	<p>7-88-03 5024921</p> <p>7-88-05 5000935</p> <p>7-88-13 5001479</p> <p>7-88-15 5001480</p> <p>7-88-17 5000937</p>	<p>#1 - 15 KV To meet IEEE Standard 404</p> <p>#1 - 25 KV To meet IEEE Standard 404</p> <p>500 MCM - 15 KV</p> <p>750 MCM - 15 KV</p> <p>500 MCM - 25 KV</p>	<p>ELMD 15 PCJ-1F2 230</p> <p>ELMD 25 PCJ-1G2 230 CP SP25B003C</p> <p>ELMD 15PCJ1K2330 RTE 2604904 B35M</p> <p>ELMD 15PCJ1M2380 RTE 2604904 B09M</p> <p>ELMD 25PCJ1L2330</p>
<p>Re-Jacketing Kit - Cold Shrink (Special instruction sheet in kit)</p>	<p>7-88-30 5000938</p> <p>7-88-33 5000939</p>	<p>For use with 7-88-05</p> <p>For use with 7-88-13, 7-88-15 & 7-88-17</p>	<p>3M SJ-1A</p> <p>3M SJ-3A</p>
<p>Separable Splice Parts</p> <p>Straight Receptacle Housing </p> <p>Housing </p> <p>Insulated Cap c/w Bail </p> <p>Insulated Plug c/w Test Point </p>	<p>7-89-01 5000940</p> <p>7-89-02 5000941</p> <p>7-89-12 5000942</p> <p>7-89-14 5000943</p>	<p>600 Amp 15 KV</p> <p>600 Amp 15 KV</p> <p>600 Amp 15 KV</p> <p>600 Amp 15 KV</p>	<p>ELMD K655 YBSR</p> <p>ELMD K6561-HP</p> <p>ELMD K655-YDR</p> <p>ELMD K650 YB1P</p>



DESCRIPTION OF ITEM	DEPT. CODE NUMBER	SIZE	ORDERING INFORMATION
Separable Splice Parts 2 Way Insulated Bus Bar c/w Testpoint  3 Way Insulated Bus Bar  4 Way Insulated Bus Bar Compression Lug 	7-89-22 5000944 7-89-23 5000945 7-89-24 5000946 7-89-32 5000947 7-89-33 5000948	600 Amp 15 KV 600 Amp 15 KV 600 Amp 15 KV 500 MCM 750 MCM	ELMD K656I-BUS ELMD K656CY-BUS ELMD K656CH-BUS ELMD 03702330 ELMD 03702380
600 Amp Splice Parts Cable Adapter 	7-90-03 5000949 7-90-07 5000950 7-90-09 5000951	2/0 5KV Rubber 250MCM-5KV XLPE #1 - 15 KV XLPE CN or Sh 250MCM-5KV Rubber 500MCM-5KV XLPE CN or Sh 500 MCM - 5 KV Old Cable 250 MCM - 15 KV XLPE Sh	ELMD 655CA-F ELMD 655CA-H ELMD 655CA-J
600 Amp Splice Parts Cable Adapter 	7-90-11 5000952 7-90-13 5000953 7-90-15 5000954	500 MCM - 5 KV Rubber 500 MCM - 15 KV XLPE Sh & UD 350 MCM - 25 KV XLPE UD 500 MCM - 25 KV XLPE CN Injection adapter for 250 MCM 750 MCM - 15 KV XLPE CN or Sh Injection adapter for 500 MCM	ELMD 655CA-K ELMD 655CA-L ELMD 655CA-M

DESCRIPTION OF ITEM	DEPT. CODE NUMBER	SIZE	ORDERING INFORMATION
<p>600 Amp Splice Parts</p> <p>Retaining Ring</p> 	<p>7-90-20 5000955</p> <p>7-90-21 5000956</p> <p>7-90-22 5000957</p> <p>7-90-24 5000958</p>	<p>250 MCM STR</p> <p>350 MCM STR</p> <p>500 MCM STR</p> <p>750 MCM STR</p>	<p>ELMD 650ARR-280</p> <p>ELMD 650ARR-300</p> <p>ELMD 650ARR-330</p> <p>ELMD 650ARR-380</p>
<p>Heat Shrink Splice</p> <p>600 Volt</p> 	<p>7-91-01 5018306</p> <p>7-91-03 5000959</p> <p>7-91-04 5000960</p> <p>7-91-06 5000961</p> <p>7-91-07 5000962</p>	<p>NO SUBS</p> <p>#8 AWG - 1/0 AWG 0.20" - .80"</p> <p>#2 AWG - 4/0 AWG 0.37" - 1.10"</p> <p>3/0 AWG - 400 MCM 0.50" - 1.50"</p> <p>250 - 750 MCM 0.65" - 2.0"</p> <p>600 - 1200 MCM 1.0" to 3.0"</p>	<p>3M ITCSN-0800</p> <p>3M ITCSN-1100</p> <p>3M ITCSN-1500</p> <p>3M ITCSN-2000</p> <p>3M ITCSN-3000</p>
<p>Heat Shrink Splice</p> <p>600 Volt</p>  <p>Heat Shrink Splice Clear</p> <p>600 Volt</p>	<p>7-91-10 5018300</p> <p>7-91-12 5018301</p> <p>7-91-14 5018309</p> <p>7-91-21 5000963</p>	<p>#16 AWG - #12 AWG 0.12" - 0.35"</p> <p>#12 AWG - #6 AWG 0.16" - 0.51"</p> <p>#6 AWG - #1 AWG 0.24" - 0.75"</p> <p>2/0 Ground Leads 1" x 48"</p>	<p>T&B HS16-12-4</p> <p>T&B HS12-6-4</p> <p>T&B HS6-1-4</p> <p>3M 3MFP301</p>

DESCRIPTION OF ITEM	DEPT. CODE NUMBER	SIZE	ORDERING INFORMATION
Cold Shrink Splice Kit - For Copper or Aluminum Conductors - JCN and CN Cables - Kits include Shear-bolt connectors 	7-92-01 5001481	15 KV #1 AWG	3M 5415A-QCI-2-250-SKLP PRY 15SDJCe-C-6-3/0-ALSB RIC 62SSCNOR1-S-SASK
	7-92-03 5001482	15 KV 250 MCM	3M 5416A-QCI-2-250-SKLP PRY 15SFJCe-C-1/0-500-ALSB RIC 62SSCNOR1-SASK
	7-92-05 5001483	15 KV 500 MCM 750 MCM	3M 5417A-QCI-350-750-SKLP PRY 15SIPJCe-C-350-750-ALSB RIC 62SSCNPR2-SASK

Notes - 3M & Prysmian parts are not interchangeable. - Tape shielded cables require different splice kits or hand splices. - 1000 MCM splices are special order. - Contact Engineering Section (Spec 2326) if splicing an unknown cable in the field.	7-92-07 5001484	25 KV #1 AWG	3M 5456A-QCI-2-250-SKLP PRY 25SEJCe-C-6-3/0-ALSB RIC 62SSCNOR1-SASK
	7-92-09 5001485	25 KV 500 MCM	3M 5457A-QCI-350-750-SKLP PRY 25SIPJCe-C-1/0-500-ALSB RIC 62SSCNQR1-SASK

Voltage	#1 AWG	1/0 AWG	2/0 AWG	4/0 AWG	250 MCM	500 MCM	750 MCM
5 KV	7-92-01 3M • PRY			7-92-01 3M			
15 KV	7-92-01 3M • PRY RIC	Check with Engineering			7-92-03 3M • PRY RIC	7-92-05 3M • PRY RIC	7-92-05 3M • PRY 7-92-09 RIC
25 KV	7-92-07 3M • PRY RIC	Check with Engineering				7-92-09 3M • PRY RIC	

DESCRIPTION OF ITEM	DEPT. CODE NUMBER	SIZE	ORDERING INFORMATION
<p>Cold Shrink Splice</p> 	<p>7-92-21 5000969</p> <p>7-92-23 5000970</p> <p>7-92-25 5000971</p> <p>7-92-27 5000972</p>	<p>1000 Volt #6 - #4</p> <p>1000 Volt #2 - 1/0</p> <p>1000 Volt 2/0 - 250 MCM</p> <p>1000 Volt 500 MCM - 800 MCM</p>	<p>3M 8423-6</p> <p>3M 8425-8</p> <p>3M 8426-11</p> <p>3M 8428-18</p>
<p>Grounding Sock for Splice Kits</p>  <p>Product is non current carrying</p>	<p>7-93-02 5000973</p>	<p>4/0 500 MCM</p>	<p>3M Product #SS 2</p>

DESCRIPTION OF ITEM	DEPT. CODE NUMBER	SIZE	ORDERING INFORMATION
Relay Feeder Management GE Multilin	8-10-10 5000974		GE 760-P5-G5-S5-HI-A1-R-E
<p>Network Protector Relay</p>  <p>Grounded CT's</p>	<p>8-12-01 5020341</p> <p>8-12-02 5020353</p>	<p>MPCV-D Relay For use with: Eaton CM-22* Eaton CM-D Eaton CM-52</p> <p>*wiring kit req'd</p> <p>MNPR Relay For use with: Richards 31XNP</p>	<p>EAT 6417C82G01</p> <p>RIC 521968-H5-RS485</p>
<p>Electronic Meter, Single Phase 3 Wire, Self-Contained, 200A, 240V</p> <p>4-Jaw Socket Base</p>	8-22-50 5018069	Form 2	Aclara I210+ 727X-200174

DESCRIPTION OF ITEM	DEPT. CODE NUMBER	SIZE	ORDERING INFORMATION
<p>Electronic Meter, Single Phase 2 Wire, Transformer-Rated 20A, 120-480V (Auto Ranging)</p> <p>5-Jaw Socket Base, Demand with RS485 Communication and Mass Memory</p>	<p>8-23-72 5018070</p>	<p>Form 3</p>	<p>Honeywell A3RL ZDA210F00L4</p>
<p>Electronic Meter, Polyphase 3 Wire, 2 Element, Transformer-Rated 10A, 120-347V (Auto Ranging)</p> <p>A-Base, Demand with RS485 Communication and Mass Memory</p>	<p>8-24-22 5018080</p>	<p>Form 5</p>	<p>Honeywell A3RL ZD2210F00L4</p>
<p>Electronic Meter, Polyphase 4 Wire, 3 Element, Transformer-Rated 10A, 120-347V (Auto Ranging)</p> <p>13-Jaw Socket Base, Demand with RS485 Communication and Mass Memory</p>	<p>8-25-72 5018087</p>	<p>Form 9</p>	<p>Honeywell A3RL ZD8210F00L4</p>

DESCRIPTION OF ITEM	DEPT. CODE NUMBER	SIZE	ORDERING INFORMATION
<p>Electronic Meter (AMI), Single Phase 2 Wire, Self-Contained, 100A, 120V</p> <p>A-Base</p>	<p>8-31-00 5018081</p>	<p>Form 1</p>	<p>Honeywell GREX ZGA7K000500</p>
<p>Electronic Meter (AMI), Single Phase 3 Wire, Self-Contained, 100A, 240V</p> <p>A-Base</p> <p>4-Jaw Socket Base, Bidirectional</p> <p>4-Jaw Socket Base, Bidirectional with Remote Disconnect</p> <p>4-Jaw Socket Base, Bidirectional with Zigbee Communication</p>	<p>8-32-00 5018092</p> <p>8-32-54 5018093</p> <p>8-32-55 5018094</p> <p>8-32-56 5018215</p>	<p>Form 2</p>	<p>Honeywell GREX ZGC74000500</p> <p>Honeywell REXU ZHCWM000004</p> <p>Honeywell REXU ZHCWMA00004</p> <p>Honeywell R2S ZFCWM0B0000</p>
<p>Electronic Meter (AMI), Single Phase 2 Wire, Transformer-Rated 20A, 120-480V (Auto Ranging)</p> <p>5-Jaw Socket Base</p> <p>5-Jaw Socket Base with Mass Memory</p> <p>5-Jaw Socket Base, Demand with Mass Memory</p> <p>5-Jaw Socket Base with External Antenna and Mass Memory</p>	<p>8-33-50 5018089</p> <p>8-33-52 5018095</p> <p>8-33-53 5018096</p> <p>8-33-58 5018097</p>	<p>Form 3</p>	<p>Honeywell REXU ZHA220000004</p> <p>Honeywell A3TL ZD2210PH082</p> <p>Honeywell A3RL ZDA210PH0L4</p> <p>Honeywell A3TL ZD2210PK082</p>

DESCRIPTION OF ITEM	DEPT. CODE NUMBER	SIZE	ORDERING INFORMATION
<p>Electronic Meter (AMI), Single Phase 2 Wire, Transformer-Rated 20A, 120-480V (Auto Ranging)</p> <p>5-Jaw Socket Base, Bidirectional Demand with Mass Memory</p> <p>5-Jaw Socket Base, Demand with External Antenna and Mass Memory</p> <p>5-Jaw Socket Base, Bidirectional Demand with External Antenna and Mass Memory</p>	<p>8-33-69 5018098</p> <p>8-33-70 5018099</p> <p>8-33-85 5018090</p>	Form 3	<p>Honeywell A3RAL ZDA210PH0LG</p> <p>Honeywell A3RL ZDA210PK0L4</p> <p>Honeywell A3RAL ZDA210PK0LG</p>
<p>Electronic Meter (AMI), Polyphase 3 Wire, 2 Element, Transformer-Rated 10A, 120-347V (Auto Ranging)</p> <p>A-Base with Mass Memory</p> <p>A-Base, Demand with Mass Memory</p> <p>A-Base, Demand with External Antenna and Mass Memory</p> <p>8-Jaw Socket Base, Demand with Mass Memory</p>	<p>8-34-02 5018100</p> <p>8-34-03 5018091</p> <p>8-34-20 5018101</p> <p>8-34-53 5018102</p>	Form 5	<p>Honeywell A3TL ZD530098082</p> <p>Honeywell A3RL ZD3210P80L4</p> <p>Honeywell A3RL ZD2B10P90L4</p> <p>Honeywell A3RL ZD2210P80L4</p>
<p>Electronic Meter (AMI), Polyphase 4 Wire, 3 Element, Transformer-Rated 10A, 120-347V (Auto Ranging)</p> <p>A-Base with Mass Memory</p> <p>13-Jaw Socket Base with Mass Memory</p> <p>13-Jaw Socket Base, Demand with Mass Memory</p> <p>13-Jaw Socket Base with External Antenna and Mass Memory</p> <p>13-Jaw Socket Base, Bidirectional Demand with Mass Memory</p>	<p>8-35-02 5018103</p> <p>8-35-52 5018112</p> <p>8-35-53 5018113</p> <p>8-35-58 5018104</p> <p>8-35-69 5018105</p>	Form 9	<p>Honeywell A3TL ZD8B10P8082</p> <p>Honeywell A3TL ZD3210PH082</p> <p>Honeywell A3RL ZD3210PH0L4</p> <p>Honeywell A3TL ZD3210PK082</p> <p>Honeywell A3RAL ZD3210PH0LG</p>

DESCRIPTION OF ITEM	DEPT. CODE NUMBER	SIZE	ORDERING INFORMATION
<p>13-Jaw Socket Base, Demand with External Antenna and Mass Memory</p> <p>13-Jaw Socket Base, Demand with KYZ Pulse and Mass Memory</p> <p>13-Jaw Socket Base, Bidirectional Demand with External Antenna and Mass Memory</p> <p>13-Jaw Socket Base, Bidirectional Demand with KYZ Pulse and Mass Memory</p> <p>13-Jaw Socket Base, Demand w External Antenna, KYZ Pulse and Mass Memory</p>	<p>8-35-70 5018114</p> <p>8-35-71 5018106</p> <p>8-35-85 5018107</p> <p>8-35-86 5018108</p> <p>8-35-88 5018109</p>	Form 9	<p>Honeywell A3RL ZD3210PK0L4</p> <p>Honeywell A3RL ZD3213PH0L4</p> <p>Honeywell A3RAL ZD3210PK0LG</p> <p>Honeywell A3RAL ZD3213PH0LG</p> <p>Honeywell A3RL ZD3213PK0L4</p>
<p>Electronic Meter (AMI), Polyphase 3 Wire, Network, Self-Contained 200A, 120/208V</p> <p>5-Jaw Socket Base, Bidirectional</p> <p>5-Jaw Socket Base, Bidirectional with Remote Disconnect</p>	<p>8-36-54 5018110</p> <p>8-36-55 5018115</p>	Form 12 (Network)	<p>Honeywell REXU ZF53K000000</p> <p>Honeywell REXU ZH53KA00000</p>
<p>Electronic Meter (AMI), Polyphase 3 Wire, 2 Element, Delta, Self-Contained, 200A, 120-480V (Auto Ranging)</p> <p>5-Jaw Socket Base with Mass Memory</p> <p>5-Jaw Socket Base, Demand with Mass Memory</p>	<p>8-37-52 5018116</p> <p>8-37-53 5018117</p>	Form 12 (Delta)	<p>Honeywell A3TL ZD5310PH082</p> <p>Honeywell A3RL ZD2210PH0L4</p>



DESCRIPTION OF ITEM	DEPT. CODE NUMBER	SIZE	ORDERING INFORMATION
<p>Electronic Meter (AMI), Polyphase 4 Wire, 3 Element, Self-Contained 200A, 120-347V (Auto Ranging)</p> <p>7-Jaw Socket Base with Mass Memory</p> <p>7-Jaw Socket Base, Demand with Mass Memory</p> <p>7-Jaw Socket Base with External Antenna and Mass Memory</p> <p>7-Jaw Socket Base, Bidirectional Demand with Mass Memory</p>	<p>8-38-52 5018111</p> <p>8-38-53 5018122</p> <p>8-38-58 5018123</p> <p>8-38-69 5018124</p>	Form 16	<p>Honeywell A3TL ZD3310PH082</p> <p>Honeywell A3RL ZD3310PH0L4</p> <p>Honeywell A3TL ZD3310PK082</p> <p>Honeywell A3RAL ZD3310PH0LG</p>
<p>Electronic Meter (AMI), Polyphase 4 Wire, 3 Element, Self-Contained 200A, 120-347V (Auto Ranging)</p> <p>7-Jaw Socket Base, Demand with External Antenna and Mass Memory</p> <p>7-Jaw Socket Base, Demand with Special Multiplier x100 and Mass Memory</p> <p>7-Jaw Socket Base, Bidirectional Demand with External Antenna and Mass Memory</p>	<p>8-38-70 5018125</p> <p>8-38-74 5018118</p> <p>8-38-85 5018119</p>	Form 16	<p>Honeywell A3RL ZD3310PK0L4</p> <p>Honeywell A3RL ZD3310PH0L4</p> <p>Honeywell A3RAL ZD3310PK0LG</p>
<p>Electronic Meter (AMI), Polyphase 4 Wire, 2.5 Element, Transformer-Rated 10A, 120-480V (Auto Ranging)</p> <p>A-Base with Mass Memory</p> <p>A-Base with External Antenna and Mass Memory</p> <p>13-Jaw Socket Base, Demand with Mass Memory</p> <p>13-Jaw Socket Base, Bidirectional Demand with Mass Memory</p>	<p>8-39-02 5018120</p> <p>8-39-08 5018121</p> <p>8-39-53 5018132</p> <p>8-39-69 5018133</p>	Form 36	<p>Honeywell A3TL ZD8B10PH082</p> <p>Honeywell A3TL ZD8B10PK082</p> <p>Honeywell A3RL ZD8210PH0L4</p> <p>Honeywell A3RAL ZD8210PH0LG</p>

DESCRIPTION OF ITEM	DEPT. CODE NUMBER	SIZE	ORDERING INFORMATION
<p>Electronic Meter (AMI), Polyphase 4 Wire, 2.5 Element, Transformer-Rated 10A, 120-480V (Auto Ranging)</p> <p>13-Jaw Socket Base, Demand with External Antenna and Mass Memory</p> <p>13-Jaw Socket Base, Demand with KYZ Pulse and Mass Memory</p> <p>13-Jaw Socket Base, Bidirectional Demand with External Antenna and Mass Memory</p>	<p>8-39-70 5018126</p> <p>8-39-71 5018134</p> <p>8-39-85 5018127</p>	Form 36	<p>Honeywell A3RL ZD8210PK0L4</p> <p>Honeywell A3RL ZD3213P80L4</p> <p>Honeywell A3RAL ZD8210P9KLG</p>
<p>Electronic Meter (Power Quality), Polyphase 3 Wire, 2 Element, Transformer-Rated 10A, 120-347V (Auto Ranging)</p> <p>Flush Mount, Demand with Mass Memory</p> <p>Flush Mount, Demand with Totalized Billing and Mass Memory</p>	<p>8-44-03 5018128</p> <p>8-44-23 5018135</p>	Form 5	<p>SCHNEIDER ELEC ION7550</p> <p>SCHNEIDER ELEC ION7650</p>
<p>Electronic Meter (Power Quality), Polyphase 4 Wire, 3 Element, Transformer-Rated 10A, 120-347V (Auto Ranging)</p> <p>Flush Mount, Demand with Mass Memory</p> <p>Flush Mount, Demand with Totalized Billing and Mass Memory</p> <p>13-Jaw Socket Base, Demand with Mass Memory</p>	<p>8-45-03 5018136</p> <p>8-45-23 5018129</p> <p>8-45-53 5018130</p>	Form 9	<p>SCHNEIDER ELEC ION7550</p> <p>SCHNEIDER ELEC ION7650</p> <p>SCHNEIDER ELEC ION8650</p>



DESCRIPTION OF ITEM	DEPT. CODE NUMBER	SIZE	ORDERING INFORMATION
AMI Gatekeeper with Ethernet, Battery, Local LAN Ant and Polycarbonate NEMA4x Enclosure Modem Kit Battery Modem 698-2700 MHz LTE Low Profile Antenna	8-50-00 5018131 8-50-50 5018137 8-50-51 5018138 8-50-52 5018170 8-50-53 5018142		HONEYWELL EE1110021100 HONEYWELL 1C12599G01 HONEYWELL SIERRA WIRELESS HONEYWELL 3A35573H01
AMI Gatekeeper NMP to N-RF Terminal Adapter 9" Antenna Cable (RX Diversity) 6" Antenna Cable (Primary Cellular) 20" Ethernet Cable Modem Mount	8-50-54 5018143 8-50-55 5018144 8-50-56 5018145 8-50-57 5018139 8-50-58 5018140		HONEYWELL 3A35573H02 HONEYWELL 1B11954G01 HONEYWELL 1B11954G03 HONEYWELL 1B11989G02 HONEYWELL 1C12579H01
AMI Gatekeeper Electronic Assembly Timekeeping Battery Pure Lead Acid Battery Ethernet Surge Protective Device Power Supply/Lead Acid Battery Charger Thermostat	8-50-59 5018141 8-50-60 5018152 8-50-61 5018153 8-50-62 5018154 8-50-63 5018155 8-50-64 5018156		HONEYWELL 5D25648G92 HONEYWELL 1A46869H01 HONEYWELL 3A35552H02 HONEYWELL 1B12506G03 HONEYWELL 3A35590H01 HONEYWELL 3A35589H02

DESCRIPTION OF ITEM	DEPT. CODE NUMBER	SIZE	ORDERING INFORMATION
AMI Gatekeeper AC Power Fuses Surge Protective Device Heater LAN RF Filter LAN Antenna	8-50-65 5018157 8-50-66 5018158 8-50-67 5018146 8-50-68 5018159 8-50-69 5018160		HONEYWELL 7S1743H002 HONEYWELL 5D26081G01 HONEYWELL 3A35589H01 HONEYWELL 7S1735H002 HONEYWELL 7S1706H001
AMI Repeater 120V, Local LAN Antenna with NEMA4 enclosure 240V, Local LAN Antenna with NEMA4 enclosure Solar with Mounting Bracket (15 Degrees) DC, Internal or External Antenna without Battery and Regulator	8-51-00 5018161 8-51-01 5018162 8-51-02 5018147 8-51-03 5018148		HONEYWELL 7S40M0G006 HONEYWELL 7S40M0G002 HONEYWELL 7S40M0G003 HONEYWELL
AMI Repeater Solar Repeater Electronic Assembly Module Solar Repeater Battery Solar Repeater Controller Solar Repeater Powered Meter Heads Repeater Pole Mount Kit 10 7/8" to 13 3/4 Solar Repeater Powered Meter Heads	8-51-50 5018163 8-51-51 5018164 8-51-52 5018149 8-51-53 5018150 8-51-54 5018151 8-51-55 5025027	12V 3.2AH for AMI internal antenna external antenna	HONEYWELL 5D26170G54 Discover D1232 HONEYWELL 1B11886H01 HONEYWELL 7S40K0G001 HONEYWELL 7S1852G002 HONEYWELL 7S41R1G006

DESCRIPTION OF ITEM	DEPT. CODE NUMBER	SIZE	ORDERING INFORMATION
<p>AMI Fieldsense</p> <p>CT-60 Dolphin Handheld, with MeterSense, Inspector and MeterCat Server</p> <p>RF Belt Clip</p> <p>Wireless OptoWave Bluetooth Wireless Optical Probe</p>	<p>8-52-00 5018165</p> <p>8-52-50 5018172</p> <p>8-52-51 5018173</p>		<p>HONEYWELL</p> <p>HONEYWELL</p> <p>HONEYWELL</p>
<p>Meter Seal</p> <p>ROTO</p> <p>Tooled</p> <p>Tooless</p>	<p>8-70-20 5000975</p> <p>8-70-21 5000976</p>	<p>4"x.014"x8" wire</p> <p>4"x.014"x8" wire</p>	<p>BRO ROTO SEAL 7050801-27</p> <p>BRO ROTO SEAL 7470801-27</p>
<p>Meter Seal</p> <p>Plastic:</p> <p>Black</p> <p>White</p> <p>Orange</p> 	<p>8-70-25 5000977</p> <p>8-70-30 5000978</p> <p>8-70-35 5000979</p>	<p>Stamped C.O.S. 1</p> <p>Stamped C.O.S. 2</p> <p>Stamped C.O.S. 3</p>	<p>(Numbered Consecutively) BRO 6302000-8-10 Model HL-8</p> <p>BRO 6302000-8-10 Model HL-8</p> <p>Model HL-8</p>

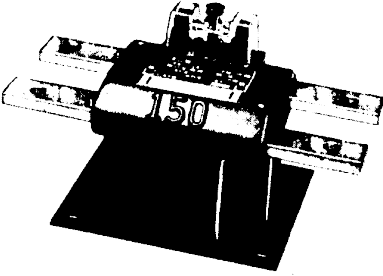
DESCRIPTION OF ITEM	DEPT. CODE NUMBER	SIZE	ORDERING INFORMATION
<p>Padlock Seal White with Green</p> 	<p>8-70-40 5000980</p>	<p>Stamped "SL&P Illegal to Tamper"</p>	<p>BRO 8001-SL&P</p>
<p>Meter Blankoff Cover Clear Polycarbonate</p>	<p>8-72-10 5000981</p>		
<p>Handi-Ring Screw Type Stainless Steel</p> <p>Locking Barrel</p>  <p>Cap Seal for Locking Barrel</p> 	<p>8-73-00 5000982</p> <p>8-73-10 5000983</p> <p>8-73-15 5000984</p>	<p>F Style Key</p>	<p>EKS 10-9090</p> <p>BRO 8730019</p> <p>BRO 9750000-1</p>

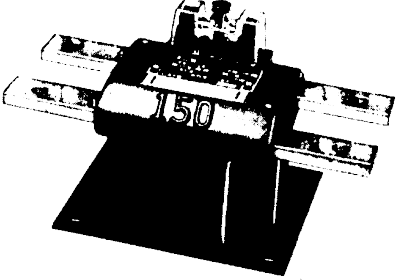
DESCRIPTION OF ITEM	DEPT. CODE NUMBER	SIZE	ORDERING INFORMATION
Adapter, Interbase Low Profile 4 Jaw	8-87-50 5000985		EKS LP-4J
Socket Adaptors SSD 2W Single Phase Residential SHD 3W Single Phase Residential STR 2W Single Phase Trans Type PTR K 3 Phase Trans Type PTR N 3 Phase Trans Type	8-88-00 5000986 8-88-05 5000987 8-88-10 5000988 8-88-15 5000989 8-88-20 5000990	2 Wire, 120 Volt 3 Wire, 240 Volt 2Wire, 240 Volt 3 Wire, 120/240 Volt 4 Wire, Auto Range Voltage	BRO 1300002 BRO 1300024 BRO 1300051 BRO 0820014 BRO 0820020
Current Transformer - 600 Volt Class Type MV-7 3 Wire  ** Discontinued MV6's will be returned from the field.	8-91-20 5000994 8-91-30 5000995	200/200:5 300/300:5	

DESCRIPTION OF ITEM	DEPT. CODE NUMBER	SIZE	ORDERING INFORMATION
<p>Current Transformer - 600 Volt Class Type MV-7 3 Wire</p>  <p>** Discontinued MV6's will be returned from the field.</p>	<p>8-91-40 5000996</p> <p>8-91-50 5000997</p> <p>8-91-60 5000998</p> <p>8-91-80 5000999</p>	<p>400/400:5</p> <p>500/500:5</p> <p>600/600:5</p> <p>800/800:5</p>	
<p>Current Transformer - 700 Volt Class Type MV-7 2 Wire</p> 	<p>8-92-10 5001000</p> <p>8-92-20 5001001</p> <p>8-92-30 5001002</p> <p>8-92-40 5001003</p> <p>8-92-50 5001004</p>	<p>100:5</p> <p>200:5</p> <p>300:5</p> <p>400:5</p> <p>500:5</p>	
<p>Current Transformer 700 Volt Class Type MV-7 2 Wire</p>  <p>R6L c/w bar assembly</p>	<p>8-92-60 5001005</p> <p>8-92-80 5001006</p> <p>8-92-81 5001007</p> <p>8-92-82 5001008</p> <p>8-92-83 5001009</p>	<p>600:5</p> <p>800:5</p> <p>1000:5</p> <p>1200:5</p> <p>2000:5</p>	<p>ITRON 9092356-729</p>

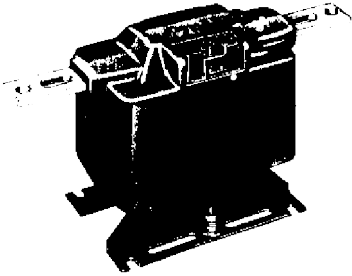
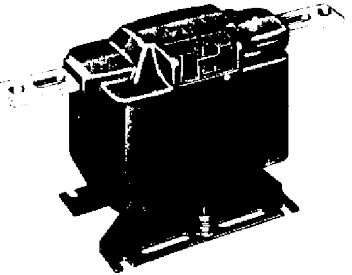
DESCRIPTION OF ITEM	DEPT. CODE NUMBER	SIZE	ORDERING INFORMATION
<p>Current Transformer - 5 KV Class Type MV-50 2 Wire</p> 	<p>8-93-02 5001010</p> <p>8-93-05 5001011</p> <p>8-93-07 5001012</p> <p>8-93-10 5001013</p>	<p>25:5</p> <p>50:5</p> <p>75:5</p> <p>100:5</p>	
<p>Current Transformer - 5 KV Class Type MV-50 2 Wire</p> 	<p>8-93-15 5001014</p> <p>8-93-20 5001015</p> <p>8-93-30 5001016</p> <p>8-93-50 5001017</p>	<p>150:5</p> <p>200:5</p> <p>300:5</p> <p>500:5</p>	
<p>Current Transformer - 5 KV Class Type MV-50 Dual Ratio</p>	<p>8-93-53 5001018</p>	<p>100/50:5</p>	

DESCRIPTION OF ITEM	DEPT. CODE NUMBER	SIZE	ORDERING INFORMATION
Potential Transformer - 600 Volt Class Type MP-6 	8-94-36 5001019 8-94-60 5001020	360:120 600:120	
Potential Transformer - 5 KV Class	8-95-24 5001021	2400:120	
Potential Transformer - 15 KV Class For Landfill - NO SUBS	8-96-08 5001022 8-96-14 5001023 8-96-18 5001024	8400:120 14400:120 14400:120	WEST PT-15 GE PV15F ABB 218D934A12 NO SUBS

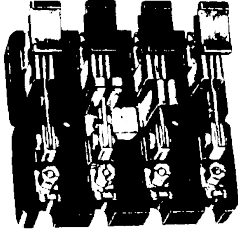
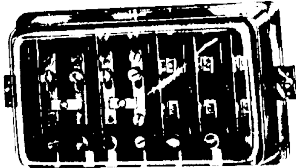
DESCRIPTION OF ITEM	DEPT. CODE NUMBER	SIZE	ORDERING INFORMATION
<p>Single Phase Dry Type Transformer - 600 - 120/240V</p> <p>Single Phase Epoxy Filled 600 - 120/240V Used in Vaults</p> <p>Three Phase 600 - 240V Delta Nema 3 Enclosure</p> <p>Three Phase 600 - 120/208V Nema 3 Enclosure</p>	<p>8-96-25 5001025</p> <p>8-96-36 5001026</p> <p>8-96-74 5001027</p> <p>8-96-75 5001028</p>	<p>25 KVA</p> <p>37 KVA</p> <p>75 KVA</p> <p>75 KVA</p>	<p>FER-P</p> <p>MARC RES37.5A2</p> <p>BEM UC3075S240DD Nema 3R</p> <p>BEM UC3075V Nema 3R</p>
<p>Test Block Single Phase</p> 	<p>8-97-01 5001029</p>		<p>States Co. 80K04-A</p>
<p>Test Block - Three Phase</p> <p>Three Wire</p> 	<p>8-97-03 5001030</p>		<p>SANG 909501</p>

DESCRIPTION OF ITEM	DEPT. CODE NUMBER	SIZE	ORDERING INFORMATION
<p>Test Block - Three Phase</p> <p>Four Wire</p> 	<p>8-97-06 5001486</p>	<p>Screw Type Compression Terminal</p>	<p>MESURINA 909762</p>
<p>Primary Metering Unit Three Phase Dry Type</p> 	<p>8-98-10 5001031</p>	<p>14400/8320 Primary 200/100:5 Current</p>	<p>ABB CMU33-110 SPEC 1510</p>

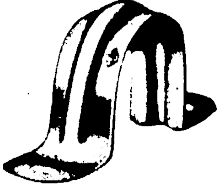
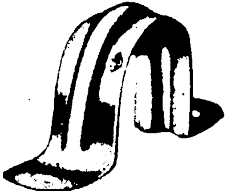
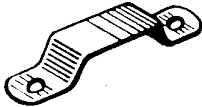
DESCRIPTION OF ITEM	DEPT. CODE NUMBER	SIZE	ORDERING INFORMATION
Rigid Two Hole Pipe Strap 	9-04-31 5001032 9-04-32 5001033 9-04-33 5001034 9-04-34 5001035	1/2" 3/4" 1" 1 1/4"	
Rigid Two Hole Pipe Strap 	9-04-35 5001036 9-04-36 5001037 9-04-37 5001038 9-04-38 5001039	1 1/2" 2" 3" 4"	
Pyrotenax Clip 	9-05-01 5001040 9-05-02 5001041 9-05-03 5001042	426/465 396/425 346/387 2 Way	

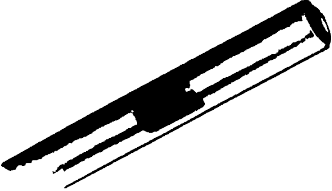
DESCRIPTION OF ITEM	DEPT. CODE NUMBER	SIZE	ORDERING INFORMATION
Galvanized Pipe 	9-09-03 5001043	2" x 21'	
HDPE Pipe	9-10-06 5001044	50 mm (2")	Specification 2412
Corrugated Pipe Grey For UG Cart & Contractors	9-10-10 5001045 9-10-11 5017526	2" Corrugated 2000 Foot Reel 2" Corrugated 500 Foot Reel	Specification 2415 Specification 2415

DESCRIPTION OF ITEM	DEPT. CODE NUMBER	SIZE	ORDERING INFORMATION
HDPE Pipe	9-10-15 5001047	100 mm (4")	Specification 2412
	9-10-16 5001048	125 mm (5")	Specification 2412
Duct Pipe PVC DB2	9-10-25 5001049	4" 20' Lengths	
	9-10-26 5001050	5" 20' Lengths	
Bend for PVC DB2 Duct Pipe 4" Flared End	9-11-04 5001051	90 Degree 24" Radius	IPEX 129047
	9-11-06 5001052	90 Degree 36" Radius	IPEX 129095
	9-11-10 5017523	11 1/4 Degree 60" Radius	Custom Made to Order
	9-11-12 5001054	22 1/2 Degree 60" Radius	Custom Made to Order
	9-11-14 5001055	45 Degree 60" Radius	IPEX 129116
	9-11-16 5001056	90 Degree 60" Radius	IPEX 129096

DESCRIPTION OF ITEM	DEPT. CODE NUMBER	SIZE	ORDERING INFORMATION
Bend for PVC DB2 Duct Pipe 5" Flared End	9-11-22 5001057	22 1/2 Degree 42" Radius	IPEX 129249
	9-11-24 5001058	45 Degree 42" Radius	IPEX 129117
	9-11-26 5001059	90 Degree 42" Radius	IPEX 129097
Bend for PVC Sched 40 4"	9-11-42 5001499	30 Degree 16" Radius	IPEX 69250
	9-11-44 5001500	45 Degree 16" Radius	IPEX 69210
	9-11-46 5001501	90 Degree 16" Radius	IPEX 69090
	9-11-48 5001502	90 Degree 36" Radius	IPEX NSL 4-36
Bend for PVC Sched 40 5"	9-11-52 5001503	30 Degree 24" Radius	IPEX 69251
	9-11-54 5001504	45 Degree 24" Radius	IPEX 69211
	9-11-56 5001505	90 Degree 24" Radius	IPEX 69091
	9-11-58 5001506	90 Degree 36" Radius	IPEX 69263

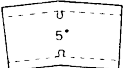
DESCRIPTION OF ITEM	DEPT. CODE NUMBER	SIZE	ORDERING INFORMATION
Bellend for PVC DB2 Duct Pipe	9-12-00 5001060	4" Flared	IPEX 029064 (Bell 40) NO SUBS
	9-12-01 5001061	4" Flared c/w Knockout Plug	IPEX 029827
	9-12-20 5001062	5" Flared	IPEX 029065 (Bell 50) NO SUBS
Plug for Bellend	9-13-00 5001063	4" Use with 9-12-00	IPEX 029078
	9-13-20 5001064	5" Use with 9-12-20	IPEX 029079
Coupling for DB2 Duct/PVC Sched 40/ Corrugated Pipe  	9-14-02 5023438 9-14-04 5001065 9-14-05 5001066 9-14-06 5001067 9-14-07 5001068 9-14-08 5001069 9-14-09 5001070 9-14-10 5001071 9-14-11 5001072	2" Plastic Coupler 1 1/2" (Rubber) 2" (Rubber) 1 1/2" - 2" (Rubber) 2" (Threaded) 2" (Corrugated) Complete with threading 2" PVC Sched 40 4" PVC DB2 4" Thin to Thick Wall	DL ARN 20000123 Fernco 1056-150 Fernco 1056-22 Fernco MR56-215 CG 08566540 IPEX 077006 IPEX 29184 4" ARLG Duct-Conduit

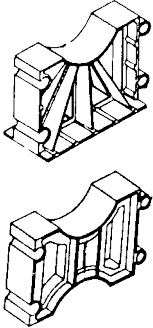
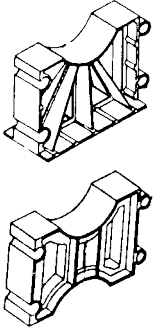
DESCRIPTION OF ITEM	DEPT. CODE NUMBER	SIZE	ORDERING INFORMATION
Coupling for DB2 Duct/PVC Sched 40/ Corrugated Pipe	9-14-12 5001073 9-14-15 5001074 9-14-18 5001075 9-14-20 5001076 9-14-21 5001077 9-14-22 5001078 9-14-40 5001507 9-14-50 5001508	4" 5 Degree Bend 5" - 4" Reducing 5" 5 Degree Bend 5" PVC 5" Thin to Thick Wall 5" Rubber 4" PVC Sched 40 5" PVC Sched 40	IPEX 029044 IPEX 029026 IPEX 029045 IPEX 077010 IPEX 077011
Spacer for PVC DB2 Duct Pipe 	9-15-01 5001079 9-15-02 5001080	Base 4" x 1 1/2" Intermediate 4" x 1 1/2"	IPEX 029573 No Alternate Supplier Unless Approved IPEX 029557 No Alternate Supplier Unless Approved
Spacer for PVC DB2 Duct Pipe 	9-15-20 5001081 9-15-22 5001082 9-15-30 5001083 9-15-32 5001084	Base 5" x 1 1/2" Intermediate 5" x 1 1/2" Base 5"x 2" Intermediate 5"x 2"	IPEX 029576 No Alternate Supplier Unless Approved IPEX 029560 No Alternate Supplier Unless Approved IPEX 029577 IPEX 029561

DESCRIPTION OF ITEM	DEPT. CODE NUMBER	SIZE	ORDERING INFORMATION
Expansion Joints for PVC Rigid Conduit	9-16-02 5001085	2"	SCEP EJ35
	9-16-04 5001086	4"	SCEP EJ55
	9-16-05 5001087	5"	IPEX EJ60
PVC Duct Primer	9-18-01 5001088	950 ml	SCEP S100TQT
PVC Duct Cement	9-18-10 5001089	950 ml	SCEP S100QT
PVC To HD Polywater Bonduit	9-18-20 5001090		BT-KITB6
Sceptacon Pipe	9-20-22 5001091	2" x 20 FT 1900 FT/Lift	IPEX 106421
	9-20-41 5001092	4" x 10 FT 540 FT/Lift	IPEX 106440
	9-20-42 5001093	4" x 20 FT 1080 FT/Lift	IPEX 106441
	9-20-51 5001094	5" x 10 FT 380 FT/Lift	IPEX 106450
	9-20-52 5001095	5" x 20 FT 760 FT/Lift	IPEX 106451

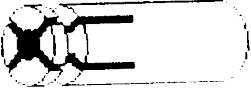
DESCRIPTION OF ITEM	DEPT. CODE NUMBER	SIZE	ORDERING INFORMATION
Sceptacon Locking Strap	9-21-02 5001096	2" Pipe	IPEX
	9-21-04 5001097	4" Pipe	IPEX
	9-21-05 5001098	5" Pipe	IPEX
Sceptacon Repair Kit Conduit Rigid & DB2 Sceptacon Adapter Kit Conduit Rigid to DB2	9-21-14 5001099	4" Conduit EPR55	IPEX 077957
	9-21-15 5001100	5" Conduit EPR60	IPEX 077956
	9-21-24 5001101	4" Conduit EPRA55	IPEX 077854
	9-21-25 5001102	5" Conduit EPRA60	IPEX 077855
Drop In Anchor 	9-30-06 5001103 9-30-08 5001104 9-30-09 5001105	NO SUBS 1/4" Bolt Size 3/8" Bolt Size 1/2" Bolt Size	Anchor Products Power Fasteners 6304SD 6306SD 6308SD

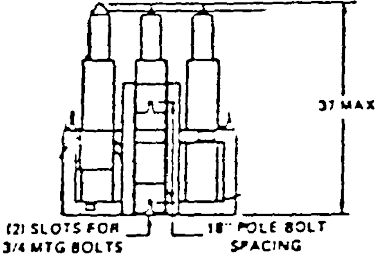
DESCRIPTION OF ITEM	DEPT. CODE NUMBER	SIZE	ORDERING INFORMATION
<p>Three Phase Capacitor Bank 4160 V, c/w Rack</p> 	<p>9-34-30 5001112</p> <p>9-34-60 5001113</p>	<p>300 KVAR</p> <p>600 KVAR</p>	<p>GE 2V33F4130BA3 Specification 5</p> <p>Specification 5</p>
<p>Three Phase Capacitor Bank 14.4 KV c/w Rack</p>	<p>9-35-50 5001114</p> <p>9-35-60 5001115</p> <p>9-35-70 5001116</p>	<p>300 KVAR</p> <p>600 KVAR</p> <p>1200 KVAR</p>	<p>Specification 1</p> <p>Specification 1</p> <p>GE 36F3144-1 Specification 1</p>
<p>Three Phase Capacitor Bank 25 KV, c/w Rack</p>	<p>9-36-60 5001117</p>	<p>600 KVAR</p>	<p>Specification 7</p>



DESCRIPTION OF ITEM	DEPT. CODE NUMBER	SIZE	ORDERING INFORMATION
<p>Master Padlock</p> 	<p>9-38-05 5001118</p> <p>9-38-07 5001119</p> <p>9-38-08 5001120</p>	<p>#3 Smaller</p> <p>#1</p> <p>#1 Long Shank</p>	<p>Keyed to 3543</p> <p>Keyed to 3543</p> <p>Keyed to 3543 Master 1KALJ</p>
<p>Yale Locks</p> <p>High Line Switch</p>	<p>9-38-14 5001121</p>		<p>Yale #870B Keyed to A25444</p>
<p>Padlock For Metering Equipment</p> 	<p>9-38-20 5001122</p> <p>9-38-25 5001123</p>	<p>3" Shackle</p> <p>1 1/2" Shackle</p>	<p>Brooks 4920571</p> <p>Brooks 4920541</p>

DESCRIPTION OF ITEM	DEPT. CODE NUMBER	SIZE	ORDERING INFORMATION
<p>Bandit</p> 	<p>9-40-04 5001124</p> <p>9-40-06 5001125</p>	<p>3/4" Stainless Steel</p> <p>3/4" Black</p>	<p>BAND C20699</p> <p>BAND C206C9-P900</p>
<p>Bandit Buckles</p> 	<p>9-41-04 5001126</p> <p>9-41-06 5001127</p>	<p>3/4" Stainless Steel</p> <p>3/4" Black</p>	<p>BAND C25699</p> <p>BAND C25699-D900</p>
<p>Heater Cabinet</p>  <p>Submersible Pump for Vaults 1/3 HP</p> 	<p>9-50-80 5001128</p> <p>9-51-00 5023010</p>	<p>800W 120V C/W Thermostat</p>	<p>Little Giant 3P640</p>

DESCRIPTION OF ITEM	DEPT. CODE NUMBER	SIZE	ORDERING INFORMATION
Grounding Ferrules - Plain Type	9-60-01 5001129	2/0	AB C600-2632
	9-60-02 5001130	4/0	AB C600-2633
Grounding Ferrules - Threaded Shrouded Type	9-61-01 5001131	2/0 Copper	AB C600-2624
	9-61-03 5001132	Copper Tin Plated 2/0	MACP 01-M-038-2/0
Shrink Tubing for Ferrules	9-61-12 5001133	9"	AB P600-2069P HA P50349-9



DESCRIPTION OF ITEM	DEPT. CODE NUMBER	SIZE	ORDERING INFORMATION
Clamps - Ground	9-62-01 5001134	#6 - 950 MCM	AB C600-0434
Clamps - Plain Eye Screw Switch	9-63-01 5001135	3/4" x 1/8" flat - 2 1/2" x 1/4" flat	MP 01-M-037 No Substitutions
Stud - Clamp Support	9-64-01 5001136 9-64-03 5001137	2 1/2" 1"	AB G3626 MACP HC-30029-1



DESCRIPTION OF ITEM	DEPT. CODE NUMBER	SIZE	ORDERING INFORMATION
Grounding Cable	9-65-01 5001138	Yellow Jacket 2/0	AB S6118
	9-65-02 5001139	Yellow Jacket 4/0	AB S6119
Ty-Wraps - White 	9-70-05 5001140	5" x .14" 100/pk	T&B TY24M
	9-70-07 5001141	7" x .19" 100/pk	T&B TY25M
	9-70-11 5001142	11" x .19" 100/pk	T&B TY253M
	9-70-13 5001143	13" x .27" 50/pk	T&B TY27M
	9-70-14 5001144	14" x .14" 100/pk	T&B TY244M
Ty-Wraps - Black 	9-71-05 5001145	5" x .14" 100/pk	T&B TY24MX
	9-71-07 5001146	7" x .19" 100/pk	T&B TY25MX
	9-71-11 5001147	11" x .19" 100/pk	T&B TY253MX
	9-71-13 5001148	13" x .27" 50/pk	T&B TY27MX
	9-71-14 5001149	14" x .14" 100/pk	T&B TY244MX
	9-71-30 5001150	30" x .27" FOR BANNERS 50/pk	T&B TY29M0 T&B TY29MX WURTH 553.59010

DESCRIPTION OF ITEM	DEPT. CODE NUMBER	SIZE	ORDERING INFORMATION
<p>Overhead Cable Support</p> <p>Ty-Wraps</p>  <p>Spacer</p> 	<p>9-72-00 5001151</p> <p>9-72-05 5001152</p>	<p>50 Per Bag</p> <p>250 Per Bag</p>	<p>T&B CSS-135</p> <p>T&B CSS-360</p>
<p>Cinch Tie with Grommet</p> 	<p>9-75-12 5001153</p>	<p>12" 10/pk</p>	<p>PAND UGCTC3S-XO</p>
<p>Locate Flags - For Buried Cable</p>	<p>9-80-00 5001155</p>	<p>Red 500/bundle</p>	<p>Harvest Community</p>

DESCRIPTION OF ITEM	DEPT. CODE NUMBER	SIZE	ORDERING INFORMATION
Gloves HV Class 0 14"	9-90-10	SZ 10	
	5001156		
	9-90-11	SZ 11	
	5001157		
	9-90-12	SZ 12	
	5001158		
	9-90-15	SZ 10.5	
	5001159		
	9-90-70	SZ 7.0	
	5001160		
	9-90-80	SZ 8.0	
	5001161		
	9-90-85	SZ 8.5	
	5001162		
9-90-90	SZ 9.0		
5001163			
9-90-95	SZ 9.5		
5001164			
Gloves HV Class 1 16"	9-91-10	SZ 10	
	5001165		
	9-91-11	SZ 11	
	5001166		
	9-91-12	SZ 12	
	5001167		
	9-91-15	SZ 10.5	
	5001168		
	9-91-70	SZ 7.0	
	5001169		
	9-91-80	SZ 8.0	
	5001170		
	9-91-85	SZ 8.5	
	5001171		
9-91-90	SZ 9.0		
5001172			
9-91-95	SZ 9.5		
5001173			
Gloves HV Class 2 16"	9-92-10	SZ 10	
	5001174		
	9-92-11	SZ 11	
	5001175		
	9-92-12	SZ 12	
	5001176		
	9-92-15	SZ 10.5	
	5001177		
	9-92-70	SZ 7.0	
	5001178		
	9-92-80	SZ 8.0	
	5001179		
	9-92-85	SZ 8.5	
	5001180		
9-92-90	SZ 9.0		
5001181			
9-92-95	SZ 9.5		
5001182			

DESCRIPTION OF ITEM	DEPT. CODE NUMBER	SIZE	ORDERING INFORMATION
Gloves HV Class 3 18"	9-93-10 5001183 9-93-11 5001184 9-93-12 5001185 9-93-15 5001186 9-93-70 5001187 9-93-80 5001188 9-93-85 5001189 9-93-90 5001190 9-93-95 5001191	SZ 10 SZ 11 SZ 12 SZ 10.5 SZ 7.0 SZ 8.0 SZ 8.5 SZ 9.0 SZ 9.5	
Mitts HV Class 2 16"	9-94-10 5001192 9-94-11 5001193 9-94-90 5001194	SZ 10 SZ 11 SZ 9.0	
Mitts HV Class 3 18"	9-95-10 5001195 9-95-11 5001196 9-95-90 5001197	SZ 10 SZ 11 SZ 9.0	

DESCRIPTION OF ITEM	DEPT. CODE NUMBER	SIZE	ORDERING INFORMATION
FR Shirts Pullover - Men's 	10-05-02 5020369 10-05-04 5020370 10-05-06 5020356 10-05-08 5020371 10-05-10 5020357 10-05-12 5020358	Small Medium Large XL 2XL 3XL	MWG 61x18
FR Shirts Pullover - Men's 	10-05-14 5020359 10-05-16 5020372 10-05-18 5020373 10-05-20 5020361 10-05-22 5020374	Medium Tall Large Tall XL Tall 2XL Tall 3XL Tall	MWG 61x18
FR Shirts Pullover - Women's 	10-06-02 5020375 10-06-04 5020552 10-06-06 5020383 10-06-08 5020376 10-06-10 5020384 10-06-12 5020377	Small Medium Large XL 2XL 3XL	Rasco FR9637

DESCRIPTION OF ITEM	DEPT. CODE NUMBER	SIZE	ORDERING INFORMATION
<p>FR Shirts Buttoned - Men's</p> 	<p>10-07-02 5020385</p> <p>10-07-04 5020386</p> <p>10-07-06 5020387</p> <p>10-07-08 5020388</p> <p>10-07-10 5020378</p> <p>10-07-12 5020379</p>	<p>Small</p> <p>Medium</p> <p>Large</p> <p>XL</p> <p>2XL</p> <p>3XL</p>	<p>Rasco FR6536OH</p>
<p>FR Shirts Buttoned - Men's</p> 	<p>10-07-14 5020389</p> <p>10-07-16 5020390</p> <p>10-07-18 5020380</p> <p>10-07-20 5020381</p> <p>10-07-22 5020391</p>	<p>Medium Tall</p> <p>Large Tall</p> <p>XL Tall</p> <p>2XL Tall</p> <p>3XL Tall</p>	<p>Rasco FR6536OH</p>
<p>FR Shirts Buttoned - Women's</p> 	<p>10-08-02 5020392</p> <p>10-08-04 5020402</p> <p>10-08-06 5020393</p> <p>10-08-08 5020403</p> <p>10-08-10 5020394</p> <p>10-08-12 5020395</p>	<p>Small</p> <p>Medium</p> <p>Large</p> <p>XL</p> <p>2XL</p> <p>3XL</p>	<p>Rasco FR9536OH</p>

DESCRIPTION OF ITEM	DEPT. CODE NUMBER	SIZE	ORDERING INFORMATION
FR Work Pants - Men's 	10-09-02 5020396 10-09-04 5020397 10-09-06 5020398 10-09-08 5020405 10-09-10 5020399 10-09-12 5020400	30" 32" 34" 36" 38" 40"	Rasco FR4133NV
FR Work Pants - Men's 	10-09-14 5020406 10-09-16 5020401 10-09-18 5020412 10-09-20 5020407 10-09-22 5020413	42" 44" 46" 48" 50"	Rasco FR4133NV
FR Work Pants - Women's 	10-10-00 5020414 10-10-02 5020415 10-10-04 5020416 10-10-06 5020417 10-10-08 5020418 10-10-10 5020419	0 (25-26") 2 (26-27") 4 (27-28") 6 (28-29") 8 (29-30") 10 (30-31")	Bulwark QP11-NV-NVY



DESCRIPTION OF ITEM	DEPT. CODE NUMBER	SIZE	ORDERING INFORMATION
FR Work Pants - Women's 	10-10-12 5020420 10-10-14 5020421 10-10-16 5020422 10-10-18 5020423 10-10-20 5020424 10-10-22 5020408	12 (31-32½") 14 (32½-34") 16 (34-35½") 18 (35½-37½") 20 (37½ - 39½") 22 (39½ - 41½")	Bulwark QP11-NV-NVY
Bulwark Sizing Chart - Woman's			



LFC-02 — ALPHA/NUMERIC CONVERSION CHART — WOMEN'S MEASUREMENTS



	XS		S		M		L		XL		XXL		3XL		4XL		
Size	0	2	4	6	8	10	12	14	16	18	20	22	24	26	28	30	32
Bust	32-33	33-34	34-35	35-36	36-37	37-38	38-39½	39½-41	41-42½	42½-44½	44½-46½	46½-48½	48½-50½	50½-52½	52½-54½	54½-56½	56½-58½
Waist	25-26	26-27	27-28	28-29	29-30	30-31	31-32½	32½-34	34-35½	35½-37½	37½-39½	39½-41½	41½-43½	43½-45½	45½-47½	47½-49½	49½-51½
Hip	34½-35½	35½-36½	36½-37½	37½-38½	38½-39½	39½-40½	40½-42	42-43½	43½-45	45-47	47-49	49-51	51-53	53-55	55-57	57-59	59-61



Height: **Petite:** 4'11"-5'3" **Regular:** 5'3½"-5'7" **Tall:** 5'7½"-5'11"



FR Cargo Pants - Men's 	10-11-02 5020409 10-11-04 5020425 10-11-06 5020410 10-11-08 5020433 10-11-10 5020434 10-11-12 5020442	30" 32" 34" 36" 38" 40"	Rasco FR4403NV



DESCRIPTION OF ITEM	DEPT. CODE NUMBER	SIZE	ORDERING INFORMATION
FR Cargo Pants - Men's 	10-11-14 5020435 10-11-16 5020555 10-11-18 5020437 10-11-20 5020443 10-11-22 5020444	42" 44" 46" 48" 50"	Rasco FR4403NV
FR Cargo Pants - Women's 	10-12-00 5020438 10-12-02 5020445 10-12-04 5020446 10-12-06 5020447 10-12-08 5020448	0 2 4 6 8	Rasco FR8403NV
FR Cargo Pants - Women's 	10-12-10 5020453 10-12-12 5020454 10-12-14 5020455 10-12-16 5020456 10-12-18 5020449	10 12 14 16 18	Rasco FR8403NV

DESCRIPTION OF ITEM	DEPT. CODE NUMBER	SIZE	ORDERING INFORMATION
<p>FR Unlined Coveralls</p> 	<p>10-15-36 5020450</p> <p>10-15-38 5020451</p> <p>10-15-40 5020462</p> <p>10-15-42 5020457</p> <p>10-15-44 5020458</p> <p>10-15-46 5020459</p>	<p>36</p> <p>38</p> <p>40</p> <p>42</p> <p>44</p> <p>46</p>	<p>Rasco FR8005OH</p>
<p>FR Unlined Coveralls</p> 	<p>10-15-48 5020463</p> <p>10-15-50 5020464</p> <p>10-15-52 5020465</p> <p>10-15-54 5020460</p>	<p>48</p> <p>50</p> <p>52</p> <p>54</p>	<p>Rasco FR8005OH</p>
<p>FR Unlined Coveralls</p> 	<p>10-16-40 5020466</p> <p>10-16-42 5020467</p> <p>10-16-44 5020468</p> <p>10-16-46 5020469</p> <p>10-16-48 5020461</p>	<p>40 Tall</p> <p>42 Tall</p> <p>44 Tall</p> <p>46 Tall</p> <p>48 Tall</p>	<p>Rasco FR8005OH</p>

DESCRIPTION OF ITEM	DEPT. CODE NUMBER	SIZE	ORDERING INFORMATION
FR Unlined Coveralls 	10-16-50 5020472 10-16-52 5020473 10-16-54 5020470	50 Tall 52 Tall 54 Tall	Rasco FR8005OH
FR Unlined Bib Overalls 	10-17-02 5020474 10-17-04 5020471 10-17-06 5020482 10-17-08 5020483 10-17-10 5020475 10-17-12 5020484	Small Medium Large XL 2XL 3XL	MWG 80E33
FR Unlined Bib Overalls 	10-17-14 5020476 10-17-16 5020477 10-17-18 5020485 10-17-20 5020486 10-17-22 5020487	Medium Tall Large Tall XL Tall 2XL Tall 3XL Tall	MWG 80E33

DESCRIPTION OF ITEM	DEPT. CODE NUMBER	SIZE	ORDERING INFORMATION
<p>FR Lined Bib Overalls</p> 	<p>10-18-02 5020488</p> <p>10-18-04 5020489</p> <p>10-18-06 5020478</p> <p>10-18-08 5020490</p> <p>10-18-10 5020491</p> <p>10-18-12 5020492</p>	<p>Small</p> <p>Medium</p> <p>Large</p> <p>XL</p> <p>2XL</p> <p>3XL</p>	<p>IFR 525</p>
<p>FR Lined Bib Overalls</p> 	<p>10-18-14 5020480</p> <p>10-18-16 5020502</p> <p>10-18-18 5020503</p> <p>10-18-20 5020493</p> <p>10-18-22 5020494</p> <p>10-18-24 5020551</p>	<p>4XL</p> <p>Large Tall</p> <p>XL Tall</p> <p>2XL Tall</p> <p>3XL Tall</p> <p>4XL Tall</p>	<p>IFR 525</p>
<p>FR Hooded Fleece</p> 	<p>10-20-02 5020496</p> <p>10-20-04 5020504</p> <p>10-20-06 5020505</p> <p>10-20-08 5020497</p> <p>10-20-10 5020498</p> <p>10-20-12 5020499</p>	<p>Small</p> <p>Medium</p> <p>Large</p> <p>XL</p> <p>2XL</p> <p>3XL</p>	<p>Rasco FR7119OH</p>





DESCRIPTION OF ITEM	DEPT. CODE NUMBER	SIZE	ORDERING INFORMATION
FR Winter Jacket 	10-22-02 5020506 10-22-04 5020500 10-22-06 5020507 10-22-08 5020501 10-22-10 5020512 10-22-12 5020535	Small Medium Large XL 2XL 3XL	IFR 515
FR Winter Jacket 	10-22-14 5020513 10-22-16 5020514 10-22-18 5020508 10-22-20 5020515 10-22-22 5020509 10-22-24 5020510	4XL Large Tall XL Tall 2XL Tall 3XL Tall 4XL Tall	IFR 515
FR Rain Overalls 	10-25-02 5020511 10-25-04 5020516 10-25-06 5020522 10-25-08 5020536 10-25-10 5020524 10-25-12 5020517	Small Medium Large XL 2XL 3XL	Lakeland ABPU10 Lakeland ABPU11 Lakeland ABPU12 Lakeland ABPU13 Lakeland ABPU14 Lakeland ABPU15

DESCRIPTION OF ITEM	DEPT. CODE NUMBER	SIZE	ORDERING INFORMATION
<p>FR Rain Overalls</p> 	<p>10-25-14 5020518</p> <p>10-25-16 5020525</p>	<p>2XL</p> <p>3XL</p>	<p>Lakeland ABPU16</p> <p>Lakeland ABPU16</p>
<p>FR Rain Jackets</p> 	<p>10-26-02 5020526</p> <p>10-26-04 5020519</p> <p>10-26-06 5020529</p> <p>10-26-08 5020520</p> <p>10-26-10 5020521</p> <p>10-26-12 5020532</p>	<p>Small</p> <p>Medium</p> <p>Large</p> <p>XL</p> <p>2XL</p> <p>3XL</p>	<p>Lakeland AJPU10</p> <p>Lakeland AJPU11</p> <p>Lakeland AJPU12</p> <p>Lakeland AJPU13</p> <p>Lakeland AJPU14</p> <p>Lakeland AJPU15</p>
<p>FR Balaclava - Warm Weather</p> <p>FR Balaclava - Cold Weather</p> <p>FR Neck Gaiter</p> <p>FR Hard Hat Liner</p> <p>FR Toque</p>	<p>10-30-10 5020533</p> <p>10-30-20 5020534</p> <p>10-30-30 5020530</p> <p>10-30-40 5020531</p> <p>10-30-50 5020542</p>	<p>O/S</p> <p>O/S</p> <p>O/S</p>	<p>Rasco BBC2</p> <p>Rasco WL2004B</p> <p>Rasco FR9142GY</p>

DESCRIPTION OF ITEM	DEPT. CODE NUMBER	SIZE	ORDERING INFORMATION
SERVICE ITEMS Oil Filter 	5024235 11-01-10	ELEMENT AS Standard Efficiency	CAT 1R-0726 (no subs)
Air Filter 	5024238 11-01-20	Axial Seal Primary Standard Efficiency	CAT 8N-6309 (no subs)
CCV Intake Filter 	5024239 11-01-25	Radial Seal Primary Standard Efficiency	CAT 2W-4246 (no subs)
Spark Plug 	5024270 11-01-30	#4	DENSO GI3-5 #4 CAT 243-4291
Fuel Train Filter 	5024271 11-01-40	28" x 5.1 " (ID)	PARKER 7CVP51-280

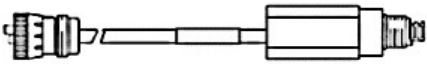

DESCRIPTION OF ITEM	DEPT. CODE NUMBER	SIZE	ORDERING INFORMATION
CCV Coalescing Filter 	5024327 11-01-45	38.62" x 4.2"	FLUTEK FLK 16-02358 HILCO DM639-00-C
Oil 	5024329 11-01-50	1 Barrel/ Drum SAE 40	CHEVRON LFG40 HDAX 9500
SCAs 	5024240 11-01-55	5 Gallon Pail	CAT 8C-3680 (no subs)
Natural Gas Coolant 	5024257 11-01-60	1 Barrel/ Drum Premix 50/50	CAT 339-3778 (no subs)
Oil Sample Kit	5024330 11-01-65	Natural Gas Engine Package	AGAT LABS 30-402 (no subs)

DESCRIPTION OF ITEM	DEPT. CODE NUMBER	SIZE	ORDERING INFORMATION
Oil Sample Cap & Probe 	5025632 11-01-67	Cap & Probe	CAT 177-9343
Coolant Sample Kit	5024258 11-01-70		CAT 320271114 (no subs)
Oil Sampling Valve	5024260 11-01-80		CAT 7X-3387 (no subs)
Oil Sampling Cap 	5024261 11-01-90		CAT 8C-3445 (no subs)
GENERAL SENSORS Thermocouple 	5024262 11-02-10	Type K PYROC/ W 24" SS Braid 1/4" probe 1/4" tube OD x 1/4" MNPT SS tube fitting Male	ADV 5601-092-28 CAT 383-2989 Swagelok



DESCRIPTION OF ITEM	DEPT. CODE NUMBER	SIZE	ORDERING INFORMATION
Timing Sensor 	5024263 11-02-30	Hex size 1.25" Thread size 3/8" - 16 13 VDC	CAT 522-1642 (no subs)
OIL SYSTEM Pre-lube Breaker 	5024265 11-03-10	30A	CAT 6N-9349 (no subs)
Oil Filter O-Ring 	5024266 11-03-30		CAT 6V-3907 (no subs)
CCV Boot 	5024280 11-03-50		CAT 217-6692
Pre-lube Pump 	5024281 11-03-70		CAT 598-6002

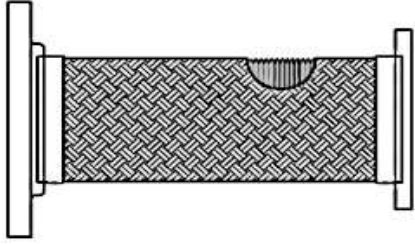

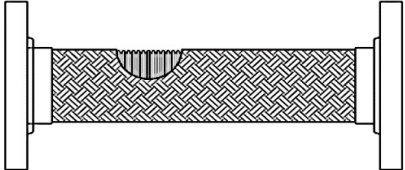

DESCRIPTION OF ITEM	DEPT. CODE NUMBER	SIZE	ORDERING INFORMATION
IGNITION SYSTEM Transformer Ignition Coil 	5024282 11-04-10	CAT 232-6346 changes up to CAT 418-4861	CAT 418-4861
Transformer Connector Body 	5024283 11-04-20		CAT 155-2270 Gregg's Distributing 763325B
Transformer Gasket 	5024284 11-04-30	ID: 36.2 mm/ OD: 46 mm/ Height: 7.25 mm/ Width: 4.94 mm	CAT 135-2651
Transformer O-Ring 	5024285 11-04-40	Material: FKM/ ID: 0.546" OD: 0.824" Cross Section Diameter: 0.139"	CAT 125-1372
Lower O-Ring 	5024286 11-04-50	Material: FKM/ ID: 0.468"/ OD: 0.624"/ Cross Section Diameter:0.078"	CAT 451-8550



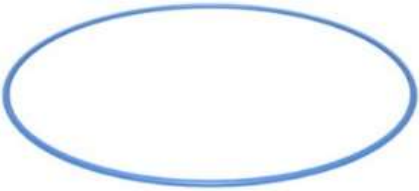

DESCRIPTION OF ITEM	DEPT. CODE NUMBER	SIZE	ORDERING INFORMATION
Upper O-Ring 	5024287 11-04-60	Material: FFKM/ ID: 0.546"/ OD: 0.824"/ Cross Section Diameter: 0.139"	CAT 187-3875
Transformer Insulator Extension 	5024288 11-04-70	Spark Plug Extension with O-ring Seal ID: 0:59" Thread Size: 3/8-16 Old Style: CAT 116-7649 with CAT 5P-6718 O-Ring	CAT 437-4043
Knock Sensor 	5024289 11-04-80	Old p/n: CAT 163-4411	CAT 574-8678
COOLANT SYSTEM Exhaust Fan Belt 	5024332 11-05-01	B-74	Generic
Exhaust Fan Bearings	5024333 11-05-05	1-7/16" Pillow Block Bearing	MOTION INDUSTRIES SO 1-7/16 PILLOW BLOCK





DESCRIPTION OF ITEM	DEPT. CODE NUMBER	SIZE	ORDERING INFORMATION
EJW Flex Inlet/ Outlet 	5024334 11-05-10	5: X 15.5" Assembly Stainless Steel Flex 1-5" CAT Flange 1-5" X 150 lb Raised Face Flange	FLEXONICS/ 5" x 16" OAL MODEL 101 CAT FLG x S/O FLG
EJW Flex Gasket Engine Side 	5024290 11-05-14	8-Bolt	CAT 1S-5772
EJW Flex Gasket Outlet Side	5024335 11-05-18	5" - 150 PSI Raised Face Flange Gasket	Generic
A/C Flex 	5024336 11-05-20	3" X 16" Assembly Stainless Steel Flex X 150 lbs Steel Flat Face Flange	FLEXONICS H-SS101-061FF061FF-048- 0016.00
A/C Flex Gasket	5024337 11-05-25	3" - 150 PSI Raised Face Flange Gasket	Generic



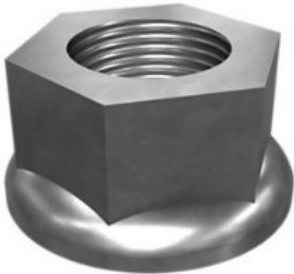

DESCRIPTION OF ITEM	DEPT. CODE NUMBER	SIZE	ORDERING INFORMATION
Block Heater Kit 	5024291 11-05-30	12 KW, 575V 3P HotStart P/N: CSM31205-000	CAT 353-7496 Order from HotStart
Element 	5024338 11-05-35	12 KW Element for CSM31205-000	HOTSTART SALES RECSM31205
Contactor 	5024339 11-05-40		HOTSTART SALES PRP232117-000
Water Pump 	5024292 11-05-45	Book out with Water Pump Gasket Kit Part: 5024313	CAT 10R-1669
Aux. Pump 	5024293 11-05-50	Book out with Parts: 5024294 5024295 5024296 5024297 5024298 5024299 5024300	CAT 20R-8813

DESCRIPTION OF ITEM	DEPT. CODE NUMBER	SIZE	ORDERING INFORMATION
Rad Fan Motor	<p>5024340 11-05-55</p>	<p>2 HP 1180RPM 3-phase 575V 60hz Shaft: 1 1/8" Bearings: DE6206 ODE 6205 Frame Size 184T</p>	<p>GENERIC - Any supplier can match specs</p>
<p>Fan Motor Bearings - Front</p> 	<p>5024341 11-05-60</p>	<p>Front</p>	<p>MOTION INDUSTRIES 6207LLUC3</p>
<p>Fan Motor Bearings - Rear</p> 	<p>5024342 11-05-65</p>	<p>Rear</p>	<p>MOTION INDUSTRIES 6206VVCE</p>
<p>Water Pump Gasket Kit</p>	<p>5024313 11-05-70</p>		<p>CAT 304-7216</p>
<p>ORDER ALL O-RINGS AND GASKETS WITH AUX. PUMP (CAT 20R-8813)</p>			
<p>Auxiliary Water Pump - O-Ring 1</p> 	<p>5024294 11-05-71</p>	<p>Material: NBR/ ID: 3.975"/ OD: 4.395"/ Cross Section Diameter: 0.21"</p>	<p>CAT 4F-7387</p>

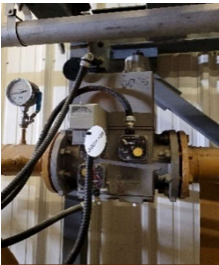

DESCRIPTION OF ITEM	DEPT. CODE NUMBER	SIZE	ORDERING INFORMATION
Auxiliary Water Pump - O-Ring 2 	5024295 11-05-72	Material: FKM/ ID: 0.725"/ OD: 1.145"/ Cross Section Diameter: 0.21"	CAT 6V-3348
Auxiliary Water Pump - O-Ring 3 	5024296 11-05-73	Material: FKM/ ID: 9.234"/ OD: 9.512"/ Cross Section Diameter: 0.139"	CAT 235-3546
Auxiliary Water Pump - O-Ring 4 	5024297 11-05-74	Material: EPDM/ ID: 2.475"/ OD: 2.895"/ Cross Section Diameter: 0.21"	CAT 8T-1919
Auxiliary Water Pump - Gasket 1 	5024298 11-05-81	Material: NMF Rubber ID: 1.50"/ OD: 2.60" Thickness: 0.06" Hole Size: 0.41" (2X) Distance between flange holes: 2.61"	CAT 5N-1940
Auxiliary Water Pump - Gasket 2 	5024299 11-05-82	Material: Sheet Overall Length: 116 mm Overall Width: 116 mm	CAT 3P-6061



DESCRIPTION OF ITEM	DEPT. CODE NUMBER	SIZE	ORDERING INFORMATION
Auxiliary Water Pump - Gasket 3 	5024300 11-05-83	Material: Sheet ID: 4.25" Length: 3.24" Width: 3.24" Thickness: 0.03" Hole Size: 0.41"(4X)	CAT 5G-1442
TURBO EXHAUST Turbo Insert Cartridge 	5024301 11-06-10	Book out with parts: 5024305 5024306 5024307 5024308 5024870	CAT 0R-6968
Wastegate (Exhaust Bypass Valve) 	5024302 11-06-20		CAT 20R-7167
Gasket (Turbo Exhaust) 	5024303 11-06-30	Overall Width: 83 mm Overall Length: 88 mm	CAT 7C-9710
Locknut 	5024304 11-06-40	410 Stainless Steel Thread size: 3/8 - 16 Height: 0.37" Drive: 9/16" Flange Diameter: 0.71"	CAT 168-7800
ORDER ALL O-RINGS AND GASKETS WITH TURBO INSERT CARTRIDGE (CAT 0R-6968)			

DESCRIPTION OF ITEM	DEPT. CODE NUMBER	SIZE	ORDERING INFORMATION
Turbo Insert Cartridge - O-Ring 	5024305 11-06-50	Material: FKM ID: 0.91" Cross Section Diameter: 0.21"	CAT 5P-9890
Turbo Insert Cartridge - Gasket 1 	5024306 11-06-60	Overall Width: 38 mm Overall Length: 72 mm	CAT 1S-4810
Turbo Insert Cartridge - Gasket 2 	5024307 11-06-70	Overall Width: 28 mm Overall Length: 66 mm	CAT 1S-6595
Turbo Insert Cartridge - Gasket 3 	5024308 11-06-80	Overall Width: 47 mm Overall Length: 78 mm	CAT 252-8374
Turbo Insert Cartridge - Intake to Manifold Gasket 	5024308 11-06-90	Overall Width: 127 mm Overall Length: 127 mm	CAT 7L-4302

DESCRIPTION OF ITEM	DEPT. CODE NUMBER	SIZE	ORDERING INFORMATION
<p>FUEL TRAIN Fuel Mixer Boot</p> 	<p>5024343 11-07-10</p>	<p>6-7" Transition Boot</p>	<p>INTAKE HOSES 7H6 (509) 489-3684, Spokane WA</p>
<p>Fuel Solenoid Valve</p> 	<p>5024344 11-07-20</p>	<p>DUNGS VPS-S04-505 DMV-D(LE) 5100/11 4" 150 Flanged</p>	<p>DUNGS VPS-S04-505</p>
<p>Fuel Alarm Modules - HP</p> 	<p>5024345 11-07-30</p>	<p>High Pressure Old p/n: 217-089A</p>	<p>DUNGS 266918</p>
<p>Fuel Alarm Modules - LP</p> 	<p>5024349 11-07-35</p>	<p>Low Pressure Old p/n: 217-088A</p>	<p>DUNGS 266917</p>
<p>Fuel Regulator</p> 	<p>5024350 11-07-40</p>	<p>FISHER 1098 EGR - Must be ordered by s/n: 20342127</p>	<p>SPARTAN</p>

DESCRIPTION OF ITEM	DEPT. CODE NUMBER	SIZE	ORDERING INFORMATION
Fuel Regulator Kit	<p>5024351 11-07-45</p>	Kit for FISHER 1098 EGR	<p>Fisher #'s R1098X00402 (Qty 2) R6352X00012 (Qty 1) R63EGX00122 (Qty 2)</p>
Fuel Flame Arrestor Element	<p>5024362 11-07-50</p>	Emerson Varec 4" Model: 501041 S/N: 1214930	FISHER____?
Fuel Flame Arrestor Gasket	<p>5024363 11-07-55</p>		FISHER____?
<p>GENERAL ENGINE Head - New</p> 	<p>5024364 11-08-10</p>	New	CAT 20R-9943
Head - Rebuild	<p>5024365 11-08-12</p>	Rebuild	TAZMECH (no exceptions)

DESCRIPTION OF ITEM	DEPT. CODE NUMBER	SIZE	ORDERING INFORMATION
Head Gasket Kit	<p>5024309 11-08-20</p>		<p>CAT 597-3813</p>
Cylinder Pack	<p>5024310 11-08-40</p>		<p>CAT 0R-7700</p>
Connecting Rod Bearings 	<p>5024311 11-08-60</p>		<p>CAT 107-7330</p>
Starter 	<p>5024312 11-08-80</p>		<p>CAT 10R-9815 or local starter shops</p>
ENGINE CONTROLS Valve - Engine Control 	<p>5024366 11-09-10</p>	<p>New</p>	<p>HEINZMANN GMCU-85-LC Can be rebuilt</p>

DESCRIPTION OF ITEM	DEPT. CODE NUMBER	SIZE	ORDERING INFORMATION
Actuator 	5024367 11-09-20	New	HEINZMANN STG-2080.21 Can be rebuilt
Governor	5024368 11-09-30	PANDAROS DC6	HEINZMANN PANDAROS DC6
MAP Sensor 	5024369 11-09-40		BOSCH O-281-002-437 ADVANTAGE GOVERNOR 600-00-082-00
Crank Position Sensor	5024370 11-09-50		ADVANTAGE GOVERNOR 600-00-006-02