

Agriplace and Marquis Industrial Area Traffic Review



Agriplace and Marquis Industrial Area Traffic Review

Authorization

Prepared By:



Mariniel Flores, P.Eng.
Transportation Engineer



Nathalie Baudais, P.Eng.
Transportation Engineer

Checked By:



David LeBoutillier, P.Eng.
Transportation Engineering Manager

Acknowledgements

The completion of this review would not be possible without the contribution of the following organizations and individuals:

- Agriplace and Marquis Industrial businesses
- Saskatoon Police Service
- Saskatoon Light and Power
- Saskatoon Fire Department
- Saskatoon Transit
- City of Saskatoon Environmental Services
- City of Saskatoon Planning and Development
- City of Saskatoon Roadways, Fleet and Support
- City of Saskatoon Community Standards
- City of Saskatoon Transportation
- Councillor Randy Donauer

Executive Summary

The objective of the Neighbourhood Traffic Management Program is to address traffic concerns within neighbourhoods such as speeding, shortcutting, and pedestrian safety. The program was revised in August 2013 to address traffic concerns on a neighbourhood-wide basis. The program involves community and stakeholder consultation that provides residents and City staff the opportunity to work together in developing solutions that address traffic concerns within their neighbourhood. The process is outlined in the Traffic Calming Guidelines and Tools, City of Saskatoon, 2016.

A public meeting was held in August 2020 to identify traffic concerns and potential solutions within the Agriplace and Marquis Industrial Area. As a result of the meeting, a number of traffic assessments were completed to confirm and quantify the concerns raised by the road users in the industrial area. Based on the road users' input and the completed traffic assessments, a Traffic Plan was developed and presented to the community through video presentation posted to the project Engage page in March 2021.

A summary of recommended improvements for the Agriplace and Marquis Industrial Area is included in Table ES-1. The summary identifies the locations, recommended improvements, and justification. The schedule to implement the Traffic Plan can vary depending on the complexity of the proposed improvement. According to the Traffic Calming Guidelines and Tools document, the time frame may range from short-term (1 to 2 years); medium-term (3 to 5 years) and long-term (5 years plus). Accordingly, the goals for implementing the improvements ranges from 1 to 5 years.

The Agriplace and Marquis Industrial Traffic Plan is illustrated in Exhibit ES-1.

Agriplace and Marquis Industrial Area Traffic Review

Table ES-1: Agriplace and Marquis Industrial Area Recommended Improvements

Item	Location	Recommendation	Justification
1	Marquis Drive and Siemens Avenue	Install reflective tape on tapered end of median	Improve visibility of median
2	Millar Avenue and 60 th Street	Active Pedestrian Corridor on north leg	Improve pedestrian safety
3	Millar Avenue and 64 th Street	Active Pedestrian Corridor on north leg	Improve pedestrian safety
4	Millar Avenue (60 th Street to 64 th Street)	Speed display board for northbound traffic	Reduce speed
		Send speed data to Saskatoon Police Service to consider for enforcement	
5	East side of Kinnear Avenue (north of Silverwood Golf Course)	Sidewalks and ramps to be installed as per the Sidewalk Infill Program	Improve pedestrian safety
6	South side of Kinnear Place (east of Kinnear Avenue)		

AGRIPLACE & MARQUIS INDUSTRIAL TRAFFIC PLAN



Exhibit ES-1 Agriplace and Marquis Industrial Traffic Plan

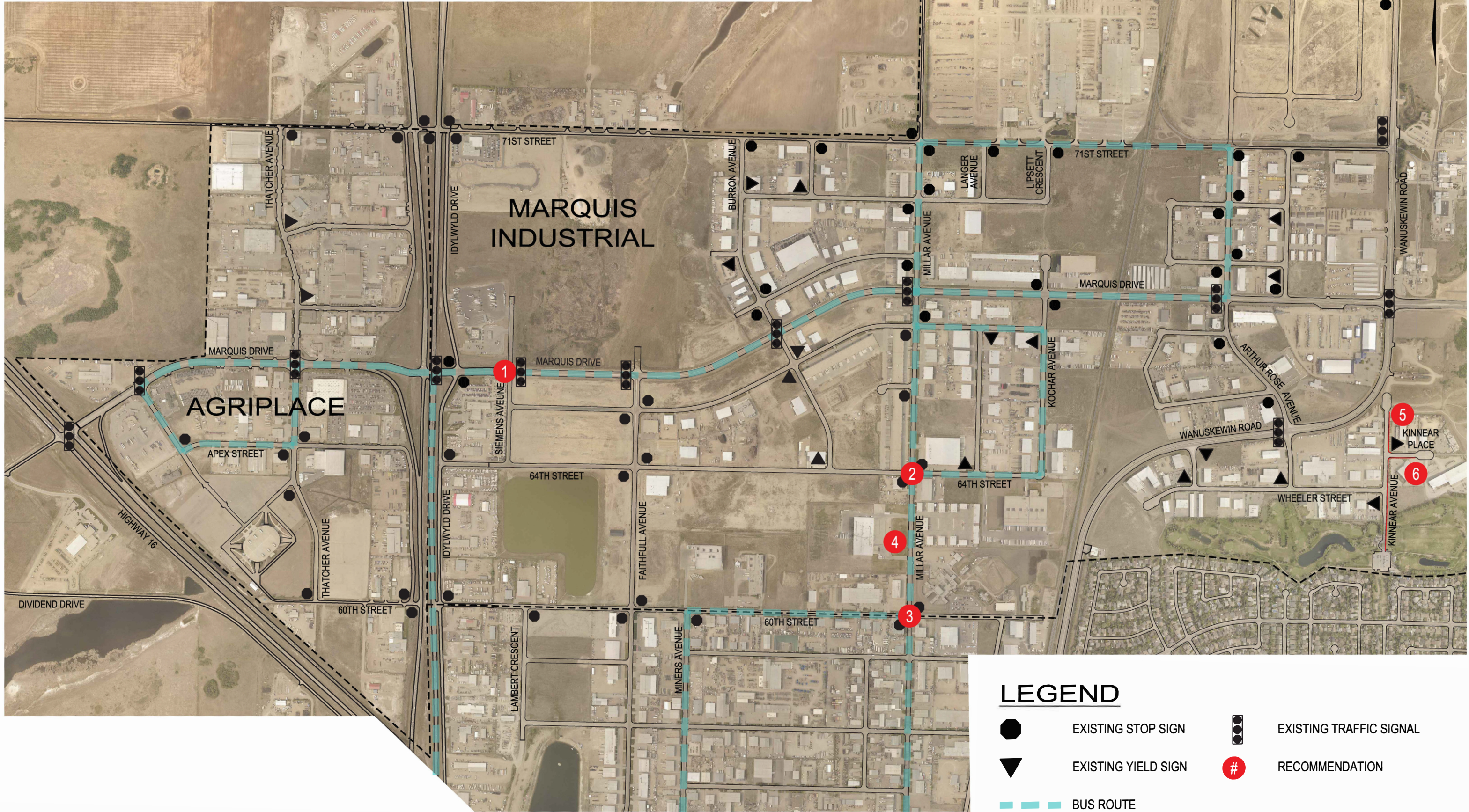

Contents

Executive Summary.....	iii
1. Introduction	1
2. Identify Issues, Concerns and Possible Solutions.....	2
2.1. Speeding and Shortcutting	2
2.2. Pedestrian Safety	2
2.3. Parking	3
2.4. Maintenance.....	3
2.5. Major Intersections and Corridors	3
3. Develop Draft Traffic Plan	4
3.1. Methodology.....	4
3.2. Traffic Volume and Speed Assessments.....	4
3.3. Pedestrian Assessments	6
3.4. Traffic Signal Assessments	7
3.5. Collision Analysis	8
4. Present Traffic Plan	9
4.1. Methodology.....	9
4.2. Speeding and Shortcutting	9
4.4. Pedestrian Safety	10
4.5. Intersection Safety.....	10
4.6. Follow-up Consultation – Presentation of Traffic Plan	10
4.7. Engagement Summary.....	11
5. Implementation	12

List of Figures

Exhibit ES-1: Agriplace and Marquis Industrial Traffic Plan.....	v
Exhibit 5-1: Recommended Agriplace and Marquis Industrial Traffic Plan	15

List of Tables

Table ES-1: Agriplace and Marquis Industrial Area Recommended Improvements	iv
Table 3-1: City of Saskatoon Street Classifications and Characteristics	5
Table 3-2: Speed Studies and Average Daily Traffic Counts (2020)	6
Table 3-3: Pedestrian Assessments	7
Table 3-4: Traffic Signal Assessments	8
Table 4-1: Recommended Improvements – Speeding and Shortcutting	9
Table 4-2: Recommended Improvements – Pedestrian Safety	10
Table 4-3: Recommended Improvements – Intersection Safety	10
Table 4-4: Public Meetings Summary	11
Table 5-1: Reflective Device and Speed Display Board Cost Estimate	12
Table 5-2: Pedestrian Devices Cost Estimate	12
Table 5-3: Pedestrian Accessible Ramps and Sidewalks Cost Estimate	13
Table 5-4: Total Cost Estimate	13
Table 5-5: Agriplace and Marquis Industrial Recommended Improvements	14

List of Appendices

APPENDIX A: Public Meeting #1 – August 20 th , 2020
APPENDIX B: Traffic Data Collection
APPENDIX C: Pedestrian Device Assessments
APPENDIX D: Traffic Signal Assessments
APPENDIX E: Collision Analysis
APPENDIX F: Public Presentation – March 8 th , 2021
APPENDIX G: Decision Matrix
APPENDIX H: Additional Concerns Received After Presentation of Draft Plan
APPENDIX I: Public Feedback

1. Introduction

As the City of Saskatoon continues to grow, many neighbourhoods face issues such as pedestrian safety, cut-through traffic, and increased speeds. In August 2013, City Council adopted the City of Saskatoon Traffic Guidelines and Tools that outlines a procedure for completing traffic reviews on a neighbourhood-wide basis. In 2016, the successful Neighbourhood Traffic Review program was expanded to include industrial areas. Prior to this, traffic issues in industrial areas were dealt with on a case-by-case basis with mixed results. Since 2013, the formal process has proven to be very successful in providing recommendations that improve neighbourhood traffic conditions and pedestrian safety. Recommendations are developed by the Administration and stakeholders in a collaborative manner. Accordingly, this report provides the Traffic Plan for the Agriplace and Marquis Industrial Area.

The Agriplace and Marquis Industrial Area is bound by 60th Street to the south, South Saskatchewan River to the east, Highway 16 to the west and 71st Street to the north. The land use is primarily industrial.

The neighbourhood traffic review includes four stages:

- **Stage 1** – Identify issues, concerns and possible solutions through the initial consultation and the Saskatoon Engage online discussion.
- **Stage 2** – Develop a draft traffic plan based on stakeholders' input and traffic assessments.
- **Stage 3** – Present the draft traffic plan to the neighbourhood at a follow-up meeting; circulate the plan to other civic departments for feedback; make adjustments as needed; and present the plan to Standing Policy Committee on Transportation.
- **Stage 4** – Implement the proposed measures in specific time frame, short-term (1 to 2 years), medium-term (3 to 5 years) or long-term (5 years plus).

This report presents the study findings and recommendations.

2. Identify Issues, Concerns and Possible Solutions

A public meeting was held in August 2020 to identify traffic concerns within the Agriplace and Marquis Industrial Area. At the meeting, business owners, employees, and road users were given the opportunity to express their concerns and suggest possible solutions. The meeting minutes and presentation are provided in **Appendix A**.

The following pages summarize the concerns and suggested solutions identified during the initial consultation with the stakeholders including all correspondence, and Saskatoon Engage discussion comments received prior to the follow-up meeting.

2.1. Speeding and Shortcutting

Shortcutting occurs when non-local traffic passes through the area on streets that are designed and intended for low volumes of traffic (i.e. local streets). As speeding often accompanies shortcutting, these concerns have been grouped into one category.

Concerns for speeding and shortcutting were identified at the following locations:

- Kinnear Avenue
- Millar Avenue

2.2. Pedestrian Safety

It is important to address pedestrian safety concerns to support active transportation. Walking to nearby amenities reduces traffic volumes.

Pedestrian crosswalks need to adhere to the City of Saskatoon Council Policy C07-018 Traffic Control at Pedestrian Crossings, which states that the installation of appropriate traffic controls at pedestrian crossings shall be based on the process outlined in the latest edition of the Transportation Association of Canada's Pedestrian Crossing Control Guide.

Concerns regarding pedestrian safety were raised at the following locations:

- Faithfull Avenue and 60th Street
- Kinnear Avenue
- Millar Avenue and 60th Street
- Millar Avenue and 64th Street
- Neepawa Street (Thatcher Avenue to Idylwyld Drive North)

The stakeholders proposed sidewalks or pedestrian crossing warning signs as possible solutions.

2.3. Parking

Parking is allowed on all city streets unless signage is posted. According to City of Saskatoon Bylaw 7200, The Traffic Bylaw, vehicles are restricted from parking within 10 metres of an intersection and one metre of a driveway or back lane.

Concerns regarding parking were identified at the following locations:

- Kinnear Avenue and Kinnear Place
- Lipsett Crescent

Stakeholders suggested parking prohibition signs to address their concerns.

2.4. Maintenance

Maintenance is requested throughout the consultation process that reflects the work of other civic departments. These include the condition of the street signs (i.e. knocked over, damaged, obstructed by trees), trees obstructing driver's view, or roadway maintenance (i.e. snow clearing, potholes, sanding).

Concerns regarding snow clearing were received along the Idylwyld Drive on-ramp from Marquis Drive.

2.5. Major Intersections and Corridors

Major intersections include roadways with higher traffic volumes (i.e. arterials, collectors) or intersections with an existing traffic signal.

Concerns regarding major intersections were raised at the following locations:

- 60th Street - Improve access
- 71st Street and Idylwyld Drive - Dangerous
- Idylwyld Drive - Congestion
- Idylwyld Drive on-ramp from Marquis Drive - Faded lane markings; Driver confusion about the number of lanes along the on-ramp
- Marquis Drive and Faithfull Avenue - Signal delays
- Marquis Drive and Highway 11 - Prioritize interchange construction
- Marquis Drive and Highway 16 - Slow; Prioritize interchange construction
- Marquis Drive and Thatcher Avenue - Long vehicle delays
- Marquis Drive and Siemens Avenue - Median barrier on west leg protruding into left westbound traffic lane
- Warman Road and 51st Street - Traffic signal head operations and reflectivity
- General - Congestion

3. Develop Draft Traffic Plan

3.1. Methodology

Stage 2 of the traffic review included development of a draft traffic plan. This was completed through the following actions:

- Create a detailed list of all the issues provided by the businesses, employees, and road users.
- Collect historical traffic studies and information the City has on file for the area.
- Prepare a data collection program that will provide the appropriate information needed to undertake the assessments.
- Complete the data collection, which may include:
 - Daily and weekly traffic counts;
 - Speed measurements;
 - Intersection turning movement counts;
 - Pedestrian counts;
 - Site observations; and
 - Collision analysis.
- Assess the issues by using the information in reference with City policies, bylaws, and guidelines, transportation engineering design guidelines and technical documents, and professional engineering judgment.

The following sections provide details on the data collected for traffic volume and speed assessments, pedestrian crossing assessments and collision analysis. A map of the traffic data collection is shown in **Appendix B**.

3.2. Traffic Volume and Speed Assessments

Traffic volumes and travel speeds were measured to assist in determining the need for traffic calming devices. In Saskatoon, the streets are classified typically as either local, collector, or arterial streets. Traffic volumes (referred to as Average Daily Traffic) on these streets should meet the City of Saskatoon guidelines shown in Table 3-1.

Agriplace and Marquis Industrial Area Traffic Review

Table 3-1: City of Saskatoon Street Classifications and Characteristics

Characteristic	Classifications									
	Back Lanes		Locals		Collectors		Arterials		Freeways / Expressways	
	Residential	Commercial	Residential	Commercial	Residential	Commercial	Minor	Major		
Traffic Service Function	Land access function only (traffic movement not a consideration)		Land access primary function (traffic movement secondary consideration)		Traffic movement and land access of equal importance		Traffic movement major consideration	Traffic movement primary consideration	Traffic movement primary consideration	
Land Service/ Access	Land access only function		Land access primary function		Traffic movement and land access of equal importance		Some access control	Rigid access control	No access	
Typical Traffic Volume (veh/day)	<500	<1,000	<1,000	<5,000	<5,000	8,000 to 10,000	5,000 to 25,000		>20,000 >10,000	
Traffic Flow Characteristics	Interrupted flow		Interrupted flow		Interrupted flow		Uninterrupted flow except at signals and crosswalks		Uninterrupted flow except at signals Free-flow (grade separated)	
Typical Posted Speed Limit (kph)	20		50		50		50 to 70		80 to 90	
Typical Vehicle Type	Passenger and service vehicles	All types	Passenger and service vehicles	All types	Passenger and service vehicles	All types	All types	All types, large portion of trucks	All types, large portion of trucks	
Desirable Network Connections	Lanes, Locals		Lanes, Locals, Collectors		Locals, Collectors, Arterials		Collectors, Arterials, Freeways/Expressways		Arterials, Freeways/ Expressways	
Transit Service	Not permitted		Generally avoided		Permitted		Permitted		Express buses only	
Cyclist Facilities	No restrictions or special facilities		No restrictions or special facilities		No restrictions; special facilities considered		No restrictions; special facilities considered		Prohibited*	
Pedestrians Facilities	Permitted, no special facilities		Sidewalks provided both sides		Sidewalks provided both sides, separation from traffic lanes preferred		Sidewalks provided both sides, separation from traffic lanes required		Prohibited*	
Typical Parking Restrictions	Some restrictions		No restrictions or restrictions one side only		Few restrictions other than peak hour		Permitted, restricted or prohibited	Prohibited or peak hour restrictions	Prohibited	
Minimum Intersection Spacing (m)	As needed		60		60		200	400	800 or 1,600 between interchanges	
Typical Right-of-Way Width (m)	6		15 to 22		21 to 41		33 to 43		75 to 125	

*May be considered beyond the clear zone

Vehicle speeds were measured to determine the 85th percentile speed, which is the speed at which 85 percent of vehicles are travelling at or below. The speed limit in the Agriplace and Marquis Industrial area is 50 kph, except on Millar Avenue and Marquis Drive where the speed limit is 60 kph.

The speed studies and Average Daily Traffic (ADT) on streets where speeding was identified as a concern are summarized in Table 3-2.

Agriplace and Marquis Industrial Area Traffic Review

Table 3-2: Speed Studies and Average Daily Traffic Counts (2020)

Street	Between	Class	Average Daily Traffic (vehicles per day)	Speed (kph)
Kinnear Avenue	Kinnear Place and Wheeler Street	Local	1,000	45
Millar Avenue	60 th Street and 64 th Street	Minor Arterial	7,650	65

3.3. Pedestrian Assessments

Pedestrian assessments were conducted to determine the need for pedestrian actuated signalized crosswalks in adherence to the City of Saskatoon Council Policy C07-018 Traffic Control at Pedestrian Crossings.

Pedestrian crossing devices include:

- standard crosswalk;
- zebra crosswalk;
- rectangular rapid flashing beacon (ground mounted flashing lights);
- actuated pedestrian corridor (overhead flashing yellow lights); and
- pedestrian actuated signals.

The policy provides a decision matrix for locating pedestrian devices considering a number of elements:

- traffic signal warrants;
- pedestrian and traffic volumes;
- distance to nearest traffic control device;
- pedestrian desire line; and
- network connectivity.

Once a location has been identified as a necessary pedestrian connection, the type of pedestrian device is selected using a treatment matrix that considers traffic volume, posted speed limit and number of lanes for pedestrian crossing.

A summary of the pedestrian studies is provided in Table 3-3 and details are provided in **Appendix C**.

Agriplace and Marquis Industrial Area Traffic Review

Table 3-3: Pedestrian Assessments

Location	Pedestrian Desire Confirmation	Results
Millar Avenue and 60 th Street	Confirmed	Connection to transit stop. Active Pedestrian Corridor recommended for the north leg of the intersection.
Millar Avenue and 64 th Street	Confirmed	Connection to transit stop. Active Pedestrian Corridor recommended for the north leg of the intersection.

3.4. Traffic Signal Assessments

Assessments are conducted to determine the need for traffic signals in adherence to the Traffic Signal and Pedestrian Signal Head Warrant Handbook. A warrant system assigns points for a variety of conditions including:

- number of traffic lanes;
- posted speed limit of the street;
- distance to the nearest traffic signal; and
- number of pedestrians and vehicles at the location.

Pedestrian and traffic data is collected during the six peak hours of: 7:00 a.m. to 9:00 a.m., 11:30 a.m. to 1:30 p.m., and 4:00 p.m. to 6:00 p.m.

If a traffic signal is not warranted, additional measures to improve safety (i.e. parking restrictions, oversized stop signs) may be considered.

A summary of the traffic signal assessments is provided in Table 3-4. Details of the traffic signal assessments are provided in **Appendix D**.

Agriplace and Marquis Industrial Area Traffic Review

Table 3-4: Traffic Signal Assessments

Location	Traffic Signal Warrant Points	Results
Millar Avenue and 60 th Street	32	Traffic signal not warranted.
Millar Avenue and 64 th Street	28	

3.5. Collision Analysis

The most recently available five-year collision data (2015 to 2019) was provided by Saskatchewan Government Insurance (SGI). High-collision locations, typically noted as the locations with an average of two or more collisions per year, were reviewed in more depth to identify trends and possible improvements. Signalized intersections were not included in the collision analysis as they have higher traffic volumes resulting in higher collision trends. These intersections are studied as part of the major intersection reviews. The only intersection with two or more collisions per year within the Agriplace and Marquis Industrial Area is 60th Street and Idylwyld Drive.

Details of the collision analysis are provided **Appendix E**.

4. Present Traffic Plan

4.1. Methodology

Stage 3 of the traffic review included finalizing the traffic plan. This was achieved by completing the following steps:

- Based on the assessments, prepare a draft plan that illustrates the appropriate recommended improvements.
- Present the draft plan to the businesses, employees and road users.
- Circulate the draft plan to the civic departments for comment.
- Revise the draft plan based on feedback from the stakeholders.
- Prepare a technical document summarizing the recommended plan and project process.

The tables in the following sections provide the details of the recommended traffic plan, including the location, recommended improvement and justification of the recommended improvement.

4.2. Speeding and Shortcutting

As stated in Council Policy C07-007 Traffic Control – Use of Stop and Yield Signs, “stop signs are not to be used as speed control devices.”

The recommended improvements to address speeding and shortcutting are detailed in Table 4-1.

Table 4-1: Recommended Improvements – Speeding and Shortcutting

Location	Recommended Improvement	Justification
Millar Avenue between 60 th Street to 64 th Street	Speed display board for northbound traffic	Reduce speeds
	Forward speed data to Saskatoon Police Service to consider for enforcement	

4.4. Pedestrian Safety

The recommended improvements to increase pedestrian safety are detailed in Table 4-2.

Table 4-2: Recommended Improvements – Pedestrian Safety

Location	Recommended Improvement	Justification
Millar Avenue and 60 th Street	Active Pedestrian Corridor on north leg	Improve pedestrian safety
Millar Avenue and 64 th Street	Active Pedestrian Corridor on north leg	Improve pedestrian safety
East side of Kinnear Avenue, north of Silverwood Golf Course	Sidewalks and ramps to be installed as per the Sidewalk Infill Program	Improve pedestrian safety
South side of Kinnear Place, east of Kinnear Avenue		

4.5. Intersection Safety

The recommended improvements to intersections that will improve the level of safety by clearly identifying the right-of-way through traffic controls are provided in Table 4-3.

Table 4-3: Recommended Improvements – Intersection Safety

Location	Recommended Improvement	Justification
Marquis Drive and Siemens Avenue	Install reflective tape on tapered end of median	Improve visibility of median

4.6. Follow-up Consultation – Presentation of Traffic Plan

The recommended improvements were presented to stakeholders in a video presentation that was posted to the project Engage page in March 2021. The presentation and draft traffic plan are provided in **Appendix F**.

A decision matrix detailing the list of recommended improvements presented in the video are included in **Appendix G**. Additional issues raised during and after the follow-up meeting were assessed and outlined **Appendix H**. Recommendations were added to the list of improvements if necessary. The revised list of recommendations received general support from Saskatoon Police Service, Saskatoon Light and Power, Saskatoon Fire Department, Environmental Services, Parking Services, Roadways, Fleet and Support Services, and Saskatoon Transit.

4.7. Engagement Summary

Businesses, employees, and road users were invited to participate in the process through a public meeting and virtual presentation, as outlined in Table 4-4.

Table 4-4: Public Meetings Summary

Meeting Details	Meeting Purpose	Meeting Materials
Meeting #1 August 20 th , 2020 0 attendees	To identify specific traffic concerns and potential improvements	Meeting minutes and presentation included in Appendix A
Virtual Presentation March 8 th , 2021	To present the draft traffic plan	Presentation and draft traffic plan included in Appendix E

Stakeholders in the Agriplace and Marquis Industrial Area were notified of the project via:

- a flyer delivered to each business in the area;
- billboard placed on Marquis Drive prior to the first meeting;
- City of Saskatoon events calendar, saskatoon.ca/engage, and saskatoon.ca/NTR;
- notifying the appropriate City Councillor.

The Engage page was used to disseminate information about the engagement events, as well as status updates and notifications for the project. It also provided a forum for stakeholder comments.

Four stakeholders subscribed for email updates. Study updates were provided to these stakeholders at several milestones throughout the project.

Stakeholders were invited to provide their concerns and feedback through the following:

- saskatoon.ca/engage webpage;
- report a traffic issues application;
- written submissions at the meetings;
- written notes taken by the Administration at the meetings; and
- written, verbal, and e-mail submission to the Administration.

Business owners, employees, or road users who could not attend the meetings were able to view the meeting materials and provide feedback via the City's saskatoon.ca/engage website, or by phone, email, or mail. Feedback received throughout the process is included in **Appendix I**.

5. Implementation

Stage 4, the final stage of the traffic review, is to install the recommended improvements. The time frame depends upon the complexity and cost of the solution. A short-term time frame is defined by implementing the improvements within 1 to 2 years; medium-term is 3 to 5 years; and long-term is 5 years plus.

The placement of signs, pavement markings and temporary traffic calming will be completed short-term (1 to 2 years). Most often the installations take place in spring/summer of the following year. Therefore, installations for the Agriplace and Marquis Industrial Area are likely to begin in summer 2021.

The estimated costs of the improvements included in the Traffic Plan are outlined in the following tables:

- Table 5-1: Reflective Device and Speed Display Board Cost Estimate
- Table 5-2: Pedestrian Devices Cost Estimate
- Table 5-3: Pedestrian Accessible Ramps and Sidewalks Cost Estimate
- Table 5-4: Total Cost Estimate

Table 5-1: Reflective Device and Speed Display Board Cost Estimate

Location	Device	Cost Estimate	Implementation Goal
Marquis Drive and Siemens Avenue	Reflective tape (1)	\$100	1-2 Years
Millar Avenue between 60 th Street and 64 th Street	Speed Display Board (1)	\$0 (Ten devices purchased in 2017 are relocated annually.)	3-5 Years
Total		\$100	

Table 5-2: Pedestrian Devices Cost Estimate

Location	Device	Cost Estimate	Implementation Goal
Millar Avenue and 60 th Street	Active Pedestrian Corridor on north leg	\$45,000	3 to 5 years
Millar Avenue and 64 th Street	Active Pedestrian Corridor on north leg	\$45,000	
Total		\$90,000	

Agriculture and Marquis Industrial Area Traffic Review

Table 5-3: Pedestrian Accessible Ramps and Sidewalks Cost Estimate

Location	Device	Cost Estimate	Implementation Goal
East side of Kinnear Avenue, north of Silverwood Golf Course	Sidewalk (600 m)	\$300,000	5 Plus Years
	Pedestrian accessible ramps (4)	\$14,000	
South side of Kinnear Place, east of Kinnear Avenue	Sidewalk (200 m)	\$100,000	
Total		\$414,000	

Table 5-4: Total Cost Estimate

Category	Implementation Goal		
	Short-Term (1-2 years)	Medium-Term (3-5 years)	Long-Term (5 years plus)
Reflective Device and Speed Display Board	\$100	\$0	-
Pedestrian Devices	-	\$90,000	-
Pedestrian Accessible Ramps and Sidewalks	-	-	\$414,000
Total	\$100	\$90,000	\$414,000

The total cost estimate for short-term improvements (reflective device and speed display board) is \$100. The total cost estimate for medium and long-term improvements (pedestrian devices, pedestrian ramps and sidewalks) is \$504,000.

The list of recommended improvements resulting from the traffic review including the location and justification is summarized in Table 5-5.

The resulting recommended Agriculture and Marquis Industrial Area Traffic Plan is illustrated in Exhibit 5-1.

Agriplace and Marquis Industrial Area Traffic Review

Table 5-5: Agriplace and Marquis Industrial Recommended Improvements

Item	Location	Recommendation	Justification
1	Marquis Drive and Siemens Avenue	Install reflective tape on tapered end of median	Improve visibility of median
2	Millar Avenue and 60 th Street	Active Pedestrian Corridor on north leg	Improve pedestrian safety
3	Millar Avenue and 64 th Street	Active Pedestrian Corridor on north leg	Improve pedestrian safety
4	Millar Avenue (60 th Street to 64 th Street)	Speed display board for northbound traffic	Reduce speed
		Send speed data to Saskatoon Police Service to consider for enforcement	
5	East side of Kinnear Avenue (north of Silverwood Golf Course)	Sidewalks and ramps to be installed as per the Sidewalk Infill Program	Improve pedestrian safety
6	South side of Kinnear Place (east of Kinnear Avenue)		

AGRIPLACE & MARQUIS INDUSTRIAL TRAFFIC PLAN

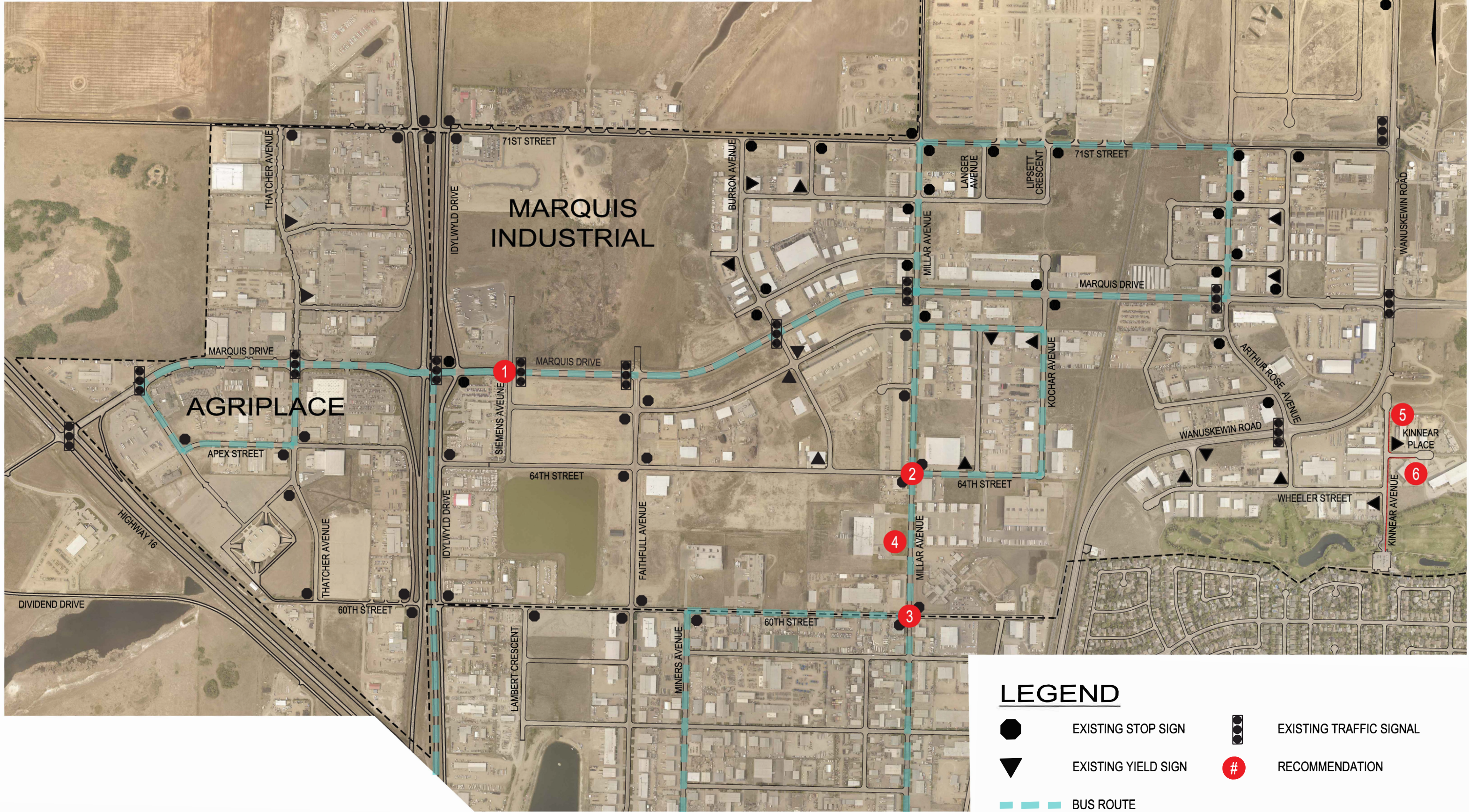

Appendix A

Public Meeting #1 – August 20th, 2020

CITY OF SASKATOON

Agriplace and Marquis Industrial Neighbourhood Traffic Review Meeting #1 Minutes

Date: Thursday, August 20, 2020

Time: 7:00 – 9:00 pm

Location: Microsoft Teams Online Meeting

Attendees:

Name	Position
Mariniel Flores	City of Saskatoon Transportation Engineer Agriplace and Marquis Industrial Neighbourhood Traffic Review Project Manager
Nathalie Baudais	City of Saskatoon Senior Transportation Engineer
Katie Sapieha	City of Saskatoon Transportation Engineer
Councillor Randy Donauer	Ward 5 City Council Representative

Items:

Welcome and Introductions

Presentation from the Transportation Division

(Presented by Mariniel Flores – Transportation Engineer)

See Video – Online meeting video recording – August 20, 2020

Updates on other relevant projects

North Saskatoon Network Planning Study:

The North Saskatoon Network Planning Study is planning the future arterial road and expressway connections to the provincial highway system in the north part of Saskatoon. The city is currently discussing the network with key stakeholders and plans to present it to Council in 2021.

Saskatoon Freeway:

The Ministry of Highways and Infrastructure, is working on a planning study for the Saskatoon Freeway which is expected to be a four-lane, 55-kilometre stretch

of divided highway that begins at Highway 11 south of Saskatoon and connects with Highway 7 west of the city. The final report of the Phase 1 study for the Saskatoon Freeway Functional Planning Study is currently under review. Phase 2 is starting. Additional information on this project can be found at saskatoonfreeway.org.

Next Steps

1. Continue monitoring traffic issues in your neighbourhood.
2. Mail-in or email comments no later than September 21, 2020.
3. Additional public input via Engage Page no later than September 21, 2020.
4. Traffic counts data collection and analysis. Due to COVID-19, we may have to wait to complete traffic counts. We are hoping to begin counting by fall.
5. Develop recommendations and prepare draft traffic plan.
6. Follow-up public meeting to provide input on draft plan.
7. Determine revisions and finalize traffic plan.
8. Present traffic plan to City Standing Policy Committee on Transportation.

Adjournment



Neighbourhood Traffic Review Agriplace and Marquis Industrial Neighbourhood

August 20, 2020



Study Area

- Study limits
 - Highway 16
 - 60th Street
 - South Saskatchewan River
 - 71st Street
- Local and collector roads

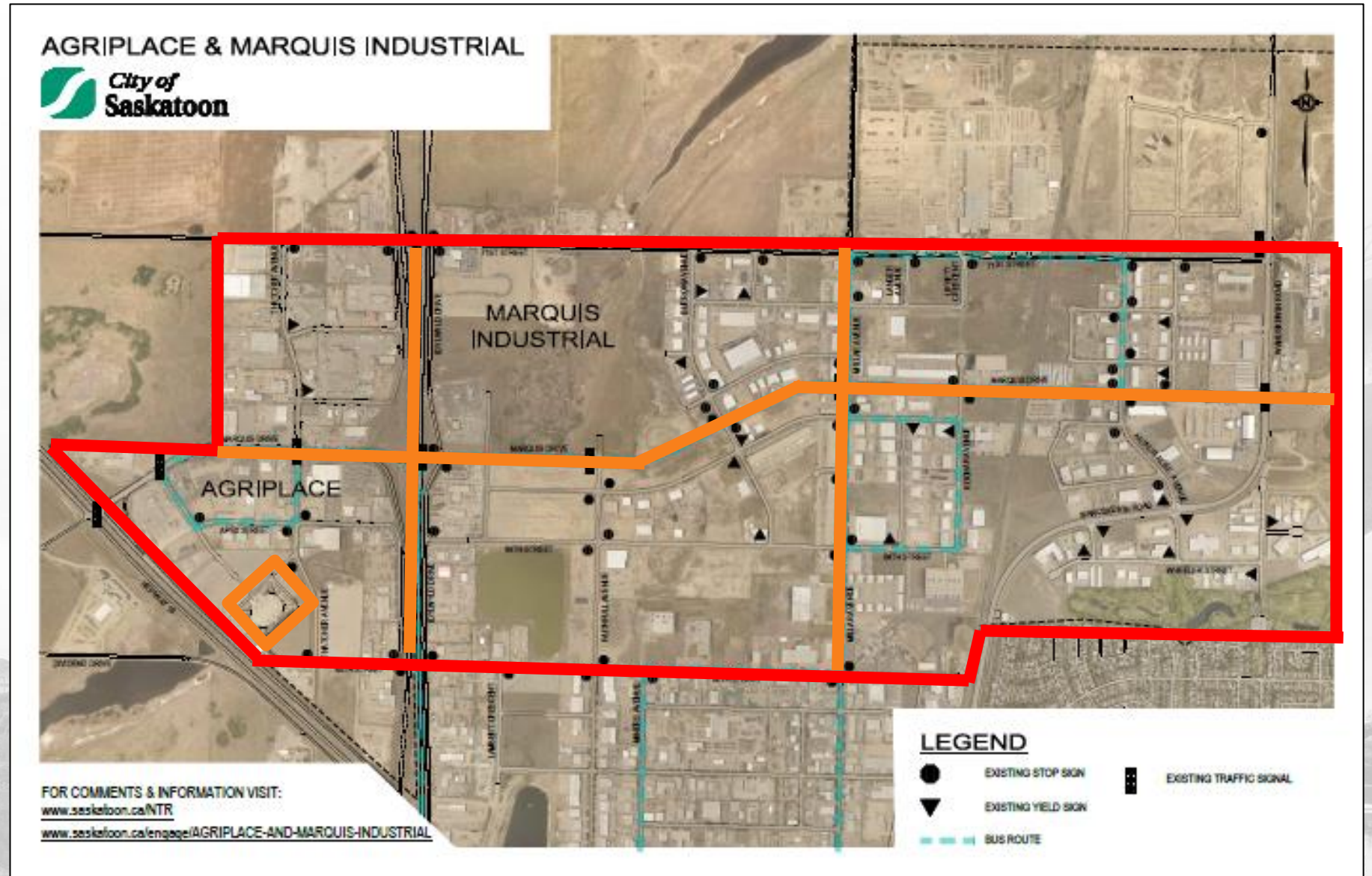

Previous Concerns - Pedestrian Safety

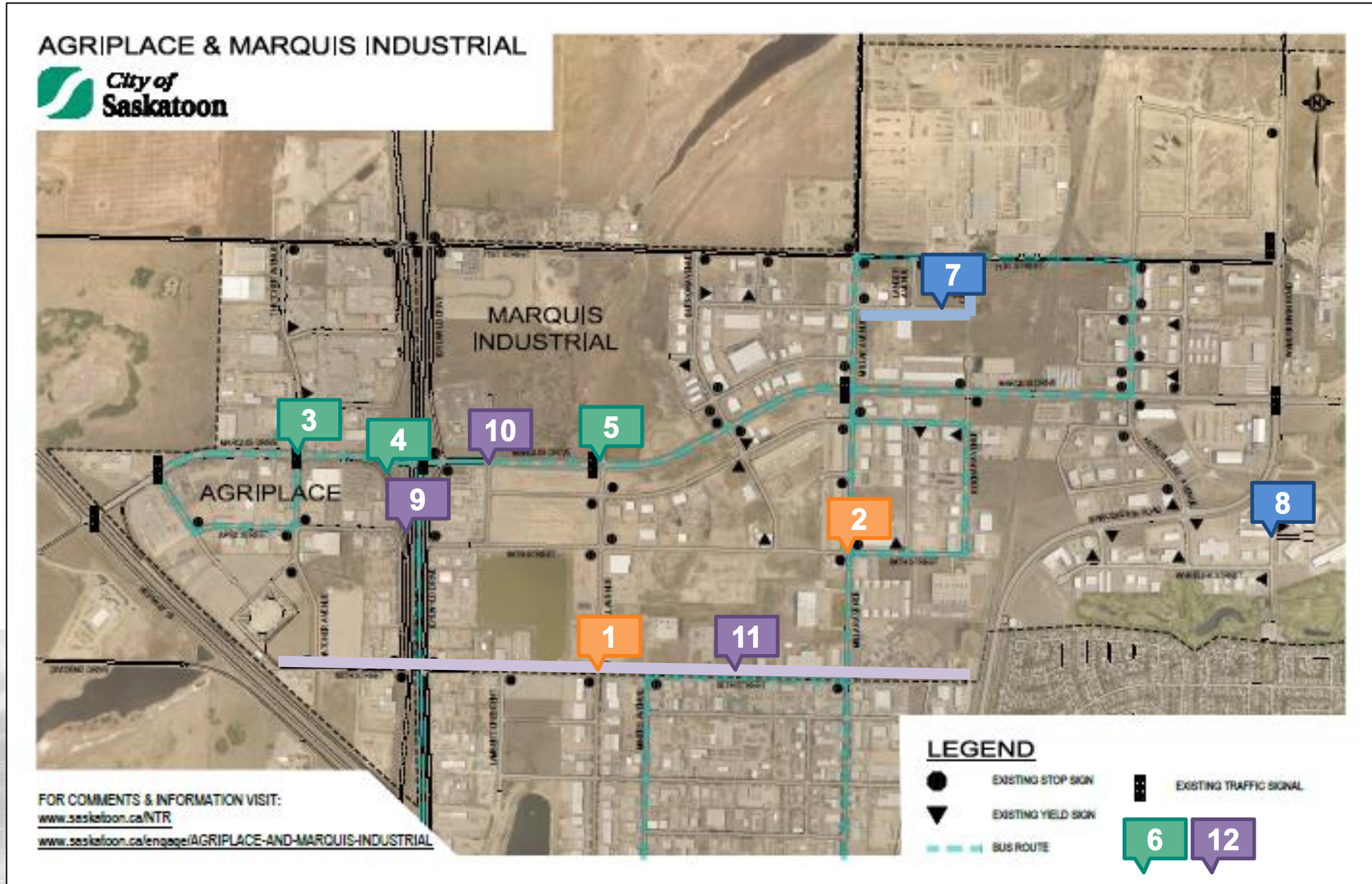

Next Steps

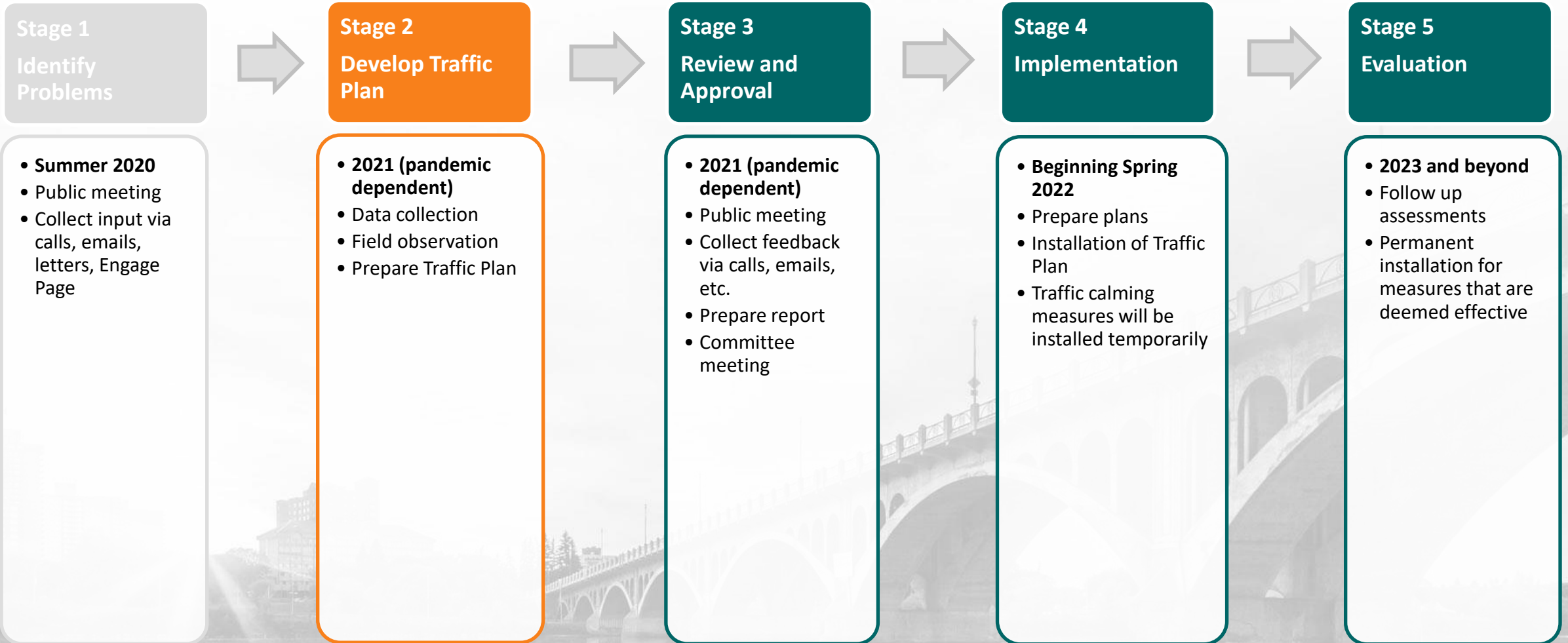

Join the Discussion

- Post comments at www.saskatoon.ca/engage
- Subscribe for updates at www.saskatoon.ca/NTR
- Report a Traffic Issue App <https://apps4.saskatoon.ca/app/aTrafficIssueReporting/>
- Call Mariniel at 306-975-3463
- Email us at ntr@saskatoon.ca
- Send us a letter

Attn: Mariniel Flores, City of Saskatoon
222 3rd Avenue North
Saskatoon, SK S7K 0J5

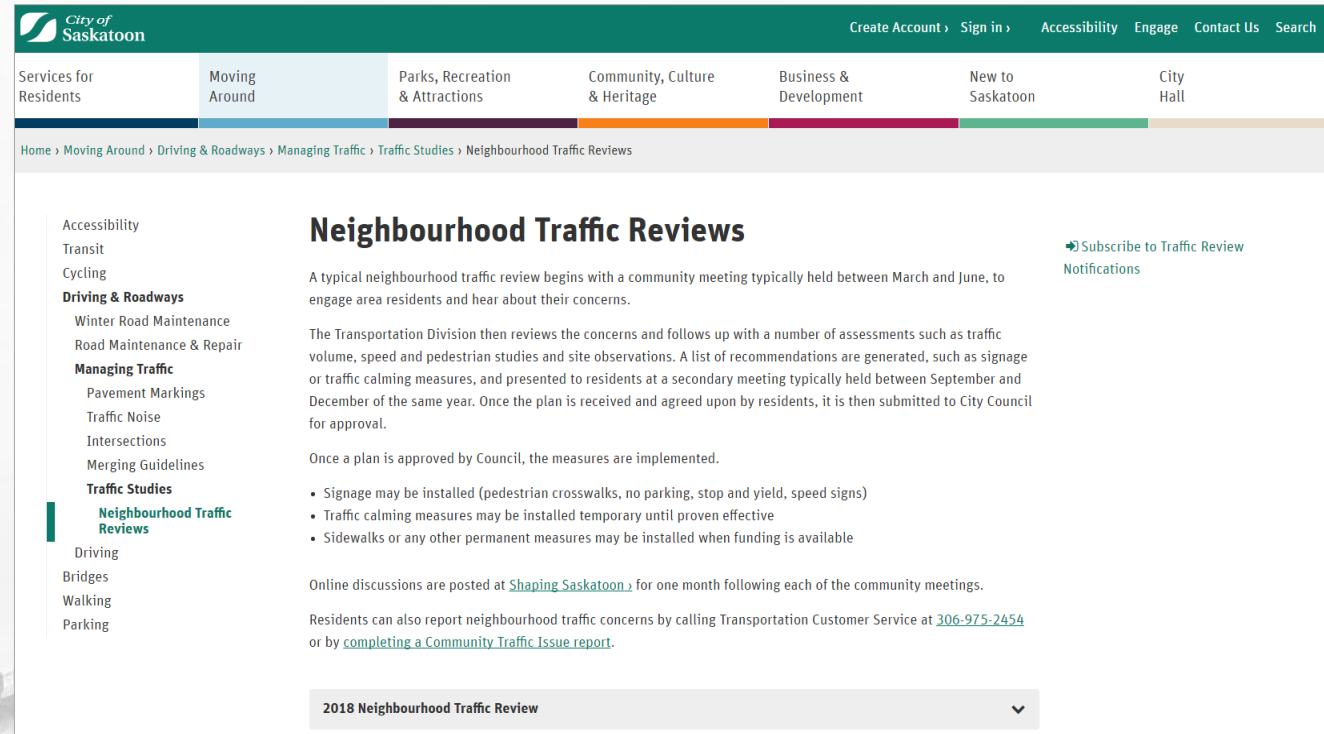

The screenshot shows the City of Saskatoon website's 'Neighbourhood Traffic Reviews' page. The header includes the City of Saskatoon logo and navigation links for 'Create Account', 'Sign in', 'Accessibility', 'Engage', 'Contact Us', and 'Search'. A secondary navigation bar lists various services: 'Services for Residents', 'Moving Around', 'Parks, Recreation & Attractions', 'Community, Culture & Heritage', 'Business & Development', 'New to Saskatoon', and 'City Hall'. The breadcrumb trail reads: 'Home > Moving Around > Driving & Roadways > Managing Traffic > Traffic Studies > Neighbourhood Traffic Reviews'. The left sidebar contains a menu with categories like 'Accessibility', 'Transit', 'Cycling', 'Driving & Roadways', 'Managing Traffic', 'Traffic Studies', and 'Neighbourhood Traffic Reviews' (which is highlighted). The main content area is titled 'Neighbourhood Traffic Reviews' and includes a 'Subscribe to Traffic Review Notifications' button. The text explains the process: a community meeting is held between March and June to engage residents, followed by a review by the Transportation Division. Recommendations are presented to residents at a secondary meeting between September and December. Once approved by Council, measures are implemented. A list of measures includes signage, temporary traffic calming, and permanent measures like sidewalks. Online discussions are posted on 'Shaping Saskatoon' for one month. Residents can also report concerns by calling 306-975-2454 or completing a 'Community Traffic Issue report'. At the bottom, there is a dropdown menu for '2018 Neighbourhood Traffic Review'.





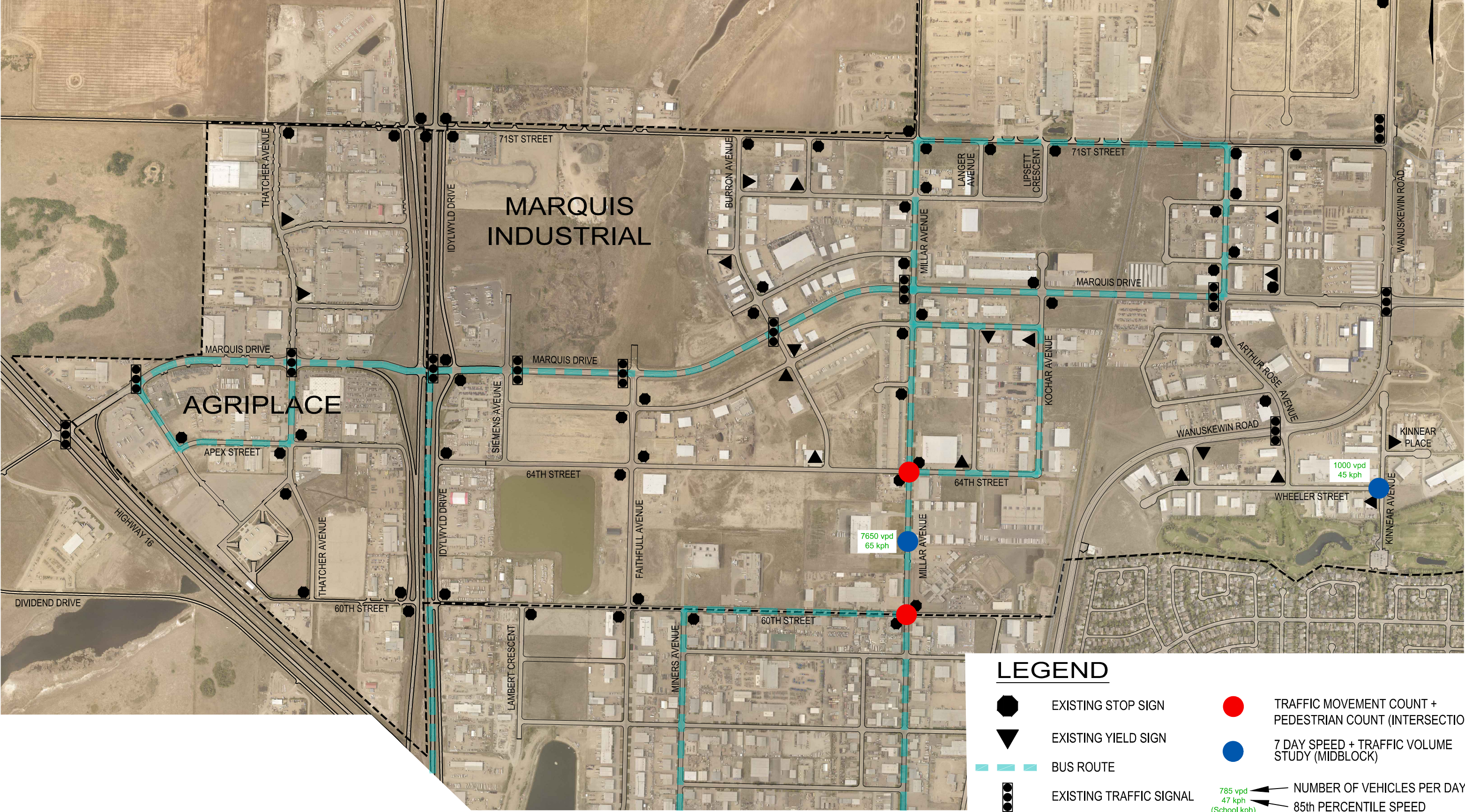

Appendix B

Traffic Data Collection

AGRIPLACE & MARQUIS INDUSTRIAL TRAFFIC DATA



LEGEND

-  EXISTING STOP SIGN
-  EXISTING YIELD SIGN
-  BUS ROUTE
-  EXISTING TRAFFIC SIGNAL
-  TRAFFIC MOVEMENT COUNT + PEDESTRIAN COUNT (INTERSECTION)
-  7 DAY SPEED + TRAFFIC VOLUME STUDY (MIDBLOCK)
-  NUMBER OF VEHICLES PER DAY
85th PERCENTILE SPEED

Appendix C

Pedestrian Device Assessments

Millar Avenue and 60th Street

Preliminary Assessment Decision Point		Pedestrian Crossing
Traffic Signal Warrant	Points	32
	Warranted (Y/N)	N
Average Hourly Pedestrian Volume ≥ 15 EAU's AND vehicular volume ≥1,500 veh/day?	Average Hourly Pedestrian Volume	1 EAU
	Vehicular Volume	7,650 veh/day (2020 count through NTR)
	Answer (Y/N)	N
Is this site > 200 metres from the nearest traffic control device?	Distance from the nearest traffic control device	> 200m
	Answer (Y/N)	Y
Is average hourly latent pedestrian crossing demand ≥ 15 EAUs OR is there requirement for system connectivity?	Answer (Y/N)	Yes. This crossing provides a connection to the bus stop on the east side of Millar Avenue north of 60 th Street.
Treatment Selection	Table-1 in Pedestrian Crossing Guide	Active Pedestrian Corridor recommended for the north side of the intersection.

¹ EAU – Equivalent Adult Units to account for pedestrian age and physical ability. Adults – 1.0 EAU; Children ≤ 12 years – 2.0 EAUs; Older pedestrians ≥ 65 years – 1.5 EAUs; Pedestrian with impairment – 2.0 EAUs.

Millar Avenue and 64th Street

Preliminary Assessment Decision Point		Pedestrian Crossing
Traffic Signal Warrant	Points	28
	Warranted (Y/N)	N
Average Hourly Pedestrian Volume \geq 15 EAU's AND vehicular volume \geq 1,500 veh/day?	Average Hourly Pedestrian Volume	1 EAU
	Vehicular Volume	7,650 veh/day (2020 count through NTR)
	Answer (Y/N)	N
Is this site > 200 metres from the nearest traffic control device?	Distance from the nearest traffic control device	> 200m
	Answer (Y/N)	Y
Is average hourly latent pedestrian crossing demand \geq 15 EAUs OR is there requirement for system connectivity?	Answer (Y/N)	Yes. This crossing provides a connection to the bus stop on the west side of Millar Avenue south of 64 th Street.
Treatment Selection	Table-1 in Pedestrian Crossing Guide	Active Pedestrian Corridor recommended for the north side of the intersection.

¹ EAU – Equivalent Adult Units to account for pedestrian age and physical ability. Adults – 1.0 EAU; Children \leq 12 years – 2.0 EAUs; Older pedestrians \geq 65 years – 1.5 EAUs; Pedestrian with impairment – 2.0 EAUs.

City of Saskatoon Canadian Matrix Traffic Signal Warrant Analysis

Main Street (name)	Millar Ave	Direction (EW or NS)	NS
Side Street (name)	60th St	Direction (EW or NS)	EW
Quadrant / Int #	#####	Comments	MF
for Warrant Calculation Results, please hit 'Page Down'	CHECK SHEET		

Road Authority:	City of Saskatoon
City:	Saskatoon
Analysis Date:	2021 Jan 25, Mon
Count Date:	2020 Oct 27, Tue
Date Entry Format:	(yyyy-mm-dd)

Lane Configuration		Excl LT	Th & LT	Through	Th-RT+LT	Th & RT	Excl RT	UpStream Signal (m)	# of Thru Lanes
Millar Ave	NB		1			1		1,100	2
Millar Ave	SB		1			1		1,600	2
60th St	WB				1				
60th St	EB				1				

Are the 60th St WB right turns significantly impeded by through movements? (y/n) n
 Are the 60th St EB right turns significantly impeded by through movements? (y/n) n

Other input		Speed (Km/h)	Truck %	Bus Rt (y/n)	Median (m)
Millar Ave	NS	50	2.0%	y	
60th St	EW		2.0%	y	

Demographics		
Elem. School/Mobility Challenged	(y/n)	n
Senior's Complex	(y/n)	n
Pathway to School	(y/n)	n
Metro Area Population	(#)	275,000
Central Business District	(y/n)	n

Traffic Input	Set Peak Hours												Ped			
	NB			SB			WB			EB			NS	NS	EW	EW
	LT	Th	RT	LT	Th	RT	LT	Th	RT	LT	Th	RT	W Side	E Side	N Side	S Side
7:00 - 8:00	35	337	36	30	401	34	8	3	6	18	8	21	0	0	0	0
8:00 - 9:00	20	331	18	6	350	33	10	3	9	16	13	24	1	0	0	0
11:30 - 12:30	22	389	22	16	416	35	22	4	20	36	4	48	0	1	2	0
12:30 - 13:30	33	369	17	16	350	35	21	5	12	39	6	33	0	0	0	0
16:00 - 17:00	19	442	8	4	378	30	28	7	35	27	7	35	0	0	0	0
17:00 - 18:00	9	331	0	2	252	15	10	4	9	26	1	23	0	0	0	0
Total (6-hour peak)	138	2,199	101	74	2,147	182	99	26	91	162	39	184	1	1	2	0
Average (6-hour peak)	23	367	17	12	358	30	17	4	15	27	7	31	0	0	0	0

Average 6-hour Peak Turning Movements

$$W = [C_{bt}(X_{v,v}) / K_1 + (F(X_{v,p}) L) / K_2] \times C_i$$

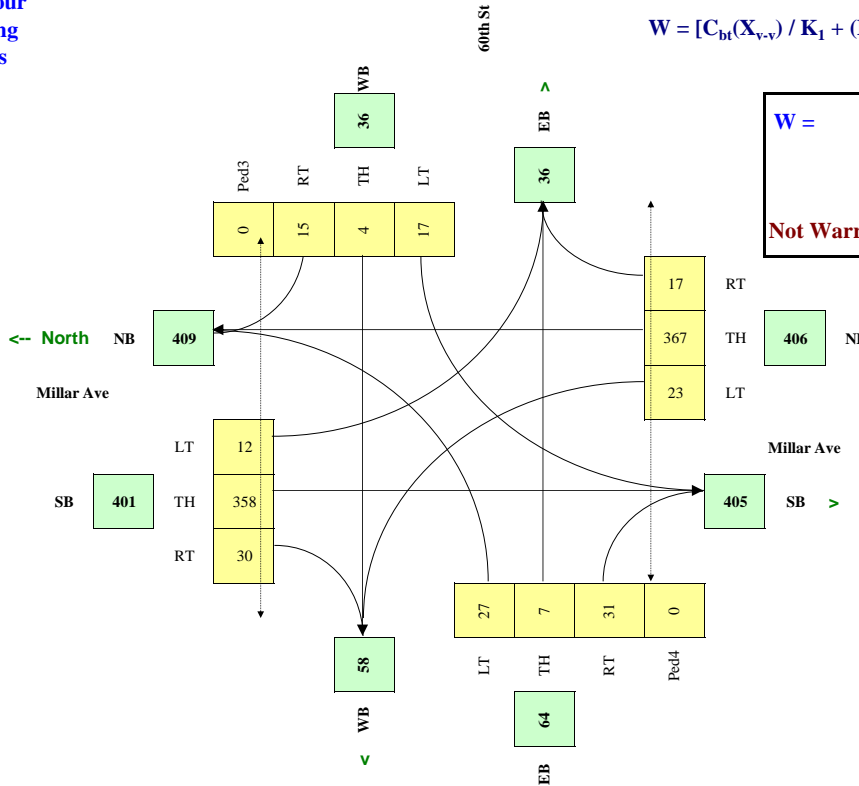

W =	32	32	0
		<i>Veh</i>	<i>Ped</i>

Not Warranted - Vs < 75

RESET SHEET

City of Saskatoon Canadian Matrix Traffic Signal Warrant Analysis

Main Street (name) **Millar Ave** Direction (EW or NS) **NS**
 Side Street (name) **64th St** Direction (EW or NS) **EW**
 Quadrant / Int # **#####** Comments **MF**
 for Warrant Calculation Results, please hit 'Page Down'

Road Authority: **City of Saskatoon**
 City: **Saskatoon**
 Analysis Date: **2021 Jan 25, Mon**
 Count Date: **2020 Oct 27, Tue**
 Date Entry Format: (yyyy-mm-dd)

Lane Configuration		Excl LT	Th & LT	Through	Th-RT+LT	Th & RT	Excl RT	UpStream Signal (m)	# of Thru Lanes
Millar Ave	NB		1			1		625	2
Millar Ave	SB		1			1		2,000	2
64th St	WB				1				
64th St	EB				1				

Are the 64th St WB right turns significantly impeded by through movements? (y/n) **n**
 Are the 64th St EB right turns significantly impeded by through movements? (y/n) **n**

Other input		Speed (Km/h)	Truck %	Bus Rt (y/n)	Median (m)
Millar Ave	NS	60	2.0%	y	
64th St	EW		2.0%	y	

Demographics		
Elem. School/Mobility Challenged	(y/n)	n
Senior's Complex	(y/n)	n
Pathway to School	(y/n)	n
Metro Area Population	(#)	275,000
Central Business District	(y/n)	n

Traffic Input	Set Peak Hours												Ped			
	NB			SB			WB			EB			NS	NS	EW	EW
	LT	Th	RT	LT	Th	RT	LT	Th	RT	LT	Th	RT	W Side	E Side	N Side	S Side
7:00 - 8:00	33	222	47	5	431	7	20	4	4	2	6	20	0	0	0	0
8:00 - 9:00	35	247	42	7	340	7	38	10	7	3	8	34	1	0	0	0
11:30 - 12:30	30	351	51	4	355	3	49	13	6	6	5	50	0	0	0	0
12:30 - 13:30	34	331	35	5	314	3	41	12	5	5	7	41	0	0	0	0
16:00 - 17:00	11	474	31	3	295	4	55	14	3	8	4	29	0	0	0	1
17:00 - 18:00	6	351	31	5	207	6	30	7	4	3	1	28	0	0	0	0
Total (6-hour peak)	149	1,976	237	29	1,942	30	233	60	29	27	31	202	1	0	0	1
Average (6-hour peak)	25	329	40	5	324	5	39	10	5	5	5	34	0	0	0	0

Average 6-hour Peak Turning Movements

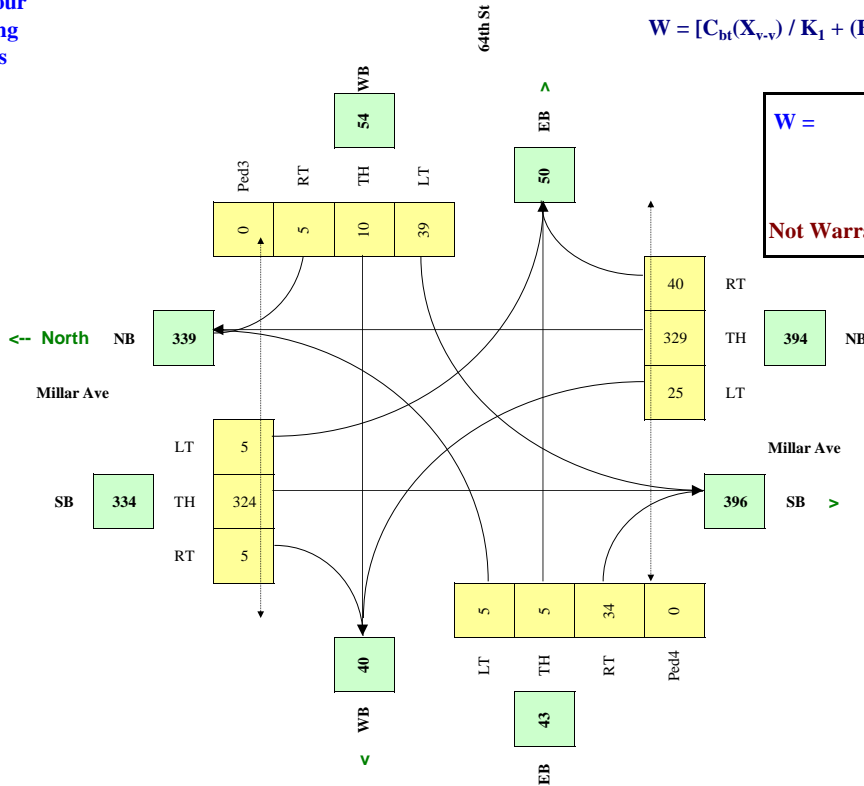

$$W = [C_{bt}(X_{v,v}) / K_1 + (F(X_{v,p}) L) / K_2] \times C_i$$

W =	28	28	0
		<i>Veh</i>	<i>Ped</i>
Not Warranted - Vs < 75			

RESET SHEET

Appendix D

Traffic Signal Assessments

City of Saskatoon Canadian Matrix Traffic Signal Warrant Analysis

Main Street (name) **Millar Ave** Direction (EW or NS) **NS**
 Side Street (name) **60th St** Direction (EW or NS) **EW**
 Quadrant / Int # **#####** Comments **MF**
 for Warrant Calculation Results, please hit 'Page Down'

Road Authority: **City of Saskatoon**
 City: **Saskatoon**
 Analysis Date: **2021 Jan 25, Mon**
 Count Date: **2020 Oct 27, Tue**
 Date Entry Format: (yyyy-mm-dd)

Lane Configuration		Excl LT	Th & LT	Through	Th-RT+LT	Th & RT	Excl RT	UpStream Signal (m)	# of Thru Lanes
Millar Ave	NB		1			1		1,100	2
Millar Ave	SB		1			1		1,600	2
60th St	WB				1				
60th St	EB				1				

Demographics		
Elem. School/Mobility Challenged	(y/n)	n
Senior's Complex	(y/n)	n
Pathway to School	(y/n)	n
Metro Area Population	(#)	275,000
Central Business District	(y/n)	n

Are the 60th St WB right turns significantly impeded by through movements? (y/n) **n**
 Are the 60th St EB right turns significantly impeded by through movements? (y/n) **n**

Other input		Speed (Km/h)	Truck %	Bus Rt (y/n)	Median (m)
Millar Ave	NS	50	2.0%	y	
60th St	EW		2.0%	y	

Traffic Input	Set Peak Hours												Ped			
	NB			SB			WB			EB			NS	NS	EW	EW
	LT	Th	RT	LT	Th	RT	LT	Th	RT	LT	Th	RT	W Side	E Side	N Side	S Side
7:00 - 8:00	35	337	36	30	401	34	8	3	6	18	8	21	0	0	0	0
8:00 - 9:00	20	331	18	6	350	33	10	3	9	16	13	24	1	0	0	0
11:30 - 12:30	22	389	22	16	416	35	22	4	20	36	4	48	0	1	2	0
12:30 - 13:30	33	369	17	16	350	35	21	5	12	39	6	33	0	0	0	0
16:00 - 17:00	19	442	8	4	378	30	28	7	35	27	7	35	0	0	0	0
17:00 - 18:00	9	331	0	2	252	15	10	4	9	26	1	23	0	0	0	0
Total (6-hour peak)	138	2,199	101	74	2,147	182	99	26	91	162	39	184	1	1	2	0
Average (6-hour peak)	23	367	17	12	358	30	17	4	15	27	7	31	0	0	0	0

Average 6-hour Peak Turning Movements

$$W = [C_{bt}(X_{v,v}) / K_1 + (F(X_{v,p}) L) / K_2] \times C_i$$

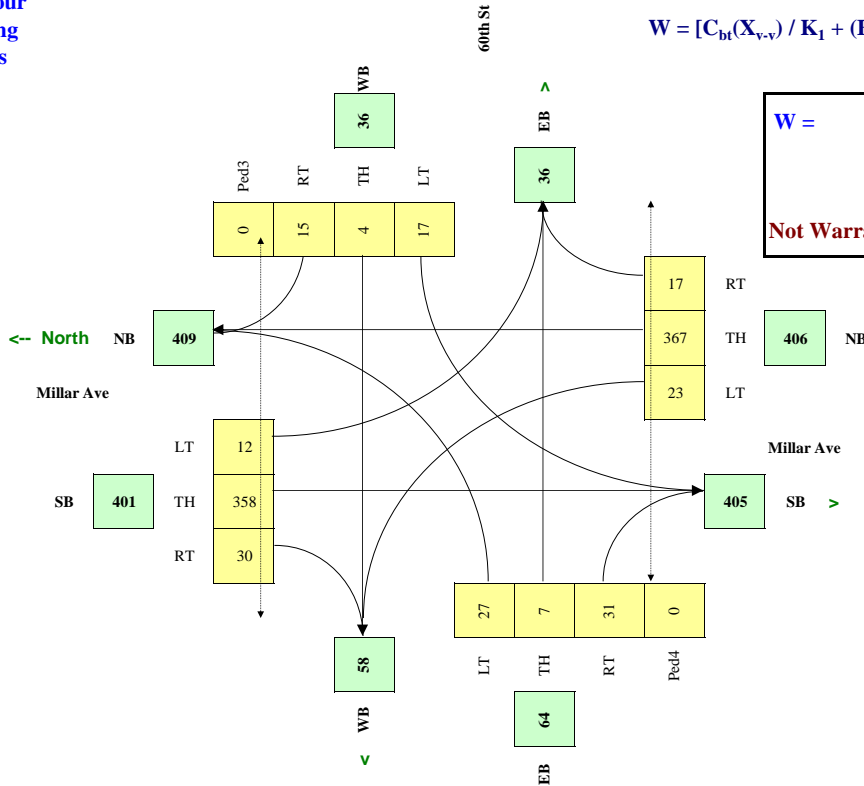

W =	32	32	0
		<i>Veh</i>	<i>Ped</i>

Not Warranted - Vs<75

RESET SHEET

City of Saskatoon Canadian Matrix Traffic Signal Warrant Analysis

Main Street (name) **Millar Ave** Direction (EW or NS) **NS**
 Side Street (name) **64th St** Direction (EW or NS) **EW**
 Quadrant / Int # **#####** Comments **MF**
 for Warrant Calculation Results, please hit 'Page Down'

Road Authority: **City of Saskatoon**
 City: **Saskatoon**
 Analysis Date: **2021 Jan 25, Mon**
 Count Date: **2020 Oct 27, Tue**
 Date Entry Format: (yyyy-mm-dd)

Lane Configuration		Excl LT	Th & LT	Through	Th-RT+LT	Th & RT	Excl RT	UpStream Signal (m)	# of Thru Lanes
Millar Ave	NB		1			1		625	2
Millar Ave	SB		1			1		2,000	2
64th St	WB				1				
64th St	EB				1				

Are the 64th St WB right turns significantly impeded by through movements? (y/n) **n**
 Are the 64th St EB right turns significantly impeded by through movements? (y/n) **n**

Other input		Speed (Km/h)	Truck %	Bus Rt (y/n)	Median (m)
Millar Ave	NS	60	2.0%	y	
64th St	EW		2.0%	y	

Demographics		
Elem. School/Mobility Challenged	(y/n)	n
Senior's Complex	(y/n)	n
Pathway to School	(y/n)	n
Metro Area Population	(#)	275,000
Central Business District	(y/n)	n

Traffic Input	Set Peak Hours												Ped			
	NB			SB			WB			EB			NS	NS	EW	EW
	LT	Th	RT	LT	Th	RT	LT	Th	RT	LT	Th	RT	W Side	E Side	N Side	S Side
7:00 - 8:00	33	222	47	5	431	7	20	4	4	2	6	20	0	0	0	0
8:00 - 9:00	35	247	42	7	340	7	38	10	7	3	8	34	1	0	0	0
11:30 - 12:30	30	351	51	4	355	3	49	13	6	6	5	50	0	0	0	0
12:30 - 13:30	34	331	35	5	314	3	41	12	5	5	7	41	0	0	0	0
16:00 - 17:00	11	474	31	3	295	4	55	14	3	8	4	29	0	0	0	1
17:00 - 18:00	6	351	31	5	207	6	30	7	4	3	1	28	0	0	0	0
Total (6-hour peak)	149	1,976	237	29	1,942	30	233	60	29	27	31	202	1	0	0	1
Average (6-hour peak)	25	329	40	5	324	5	39	10	5	5	5	34	0	0	0	0

Average 6-hour Peak Turning Movements

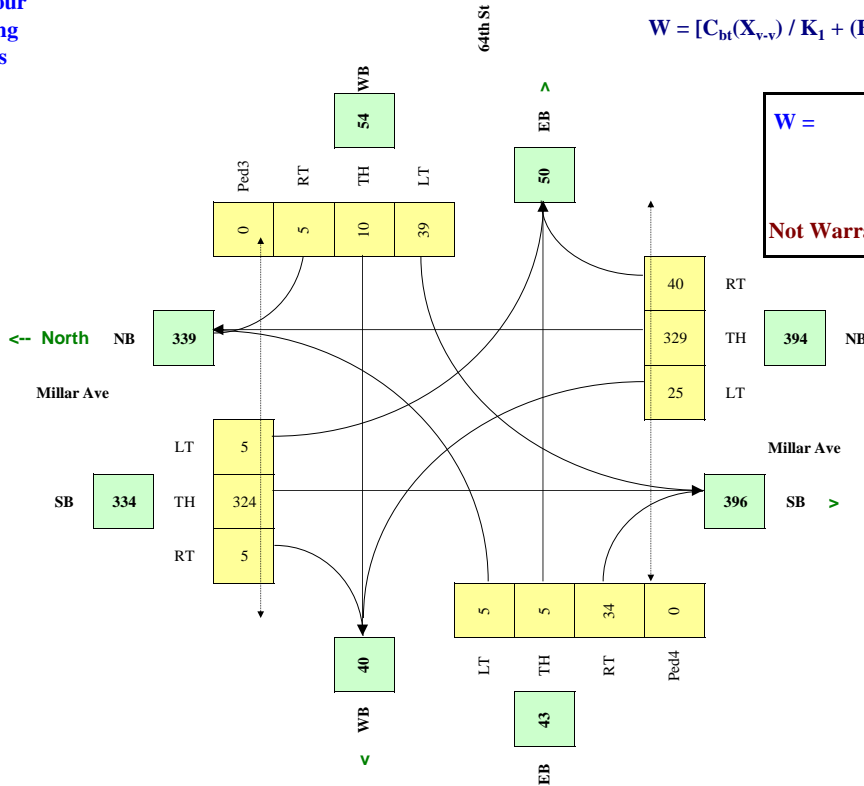

$$W = [C_{bt}(X_{v,v}) / K_1 + (F(X_{v,p}) L) / K_2] \times C_i$$

W =	28	28	0
		<i>Veh</i>	<i>Ped</i>
Not Warranted - Vs<75			

RESET SHEET

Appendix E

Collision Analysis

Street 1	Street 2	UGRID	2015	2016	2017	2018	2019	Total Number of Collisions (2015 - 2019)	Total Number of Collisions (2019)	Right Angle, Left Turn & Right Turn Only (2015 - 2019)	Right Angle, Left Turn & Right Turn Only (2019)	Average Number of Collisions (2015 - 2019)
60th St	Idylwyld Dr	SKG01-2	7	5	2	5	5	24	5	5	0	4.8
Apex St	Bill Hunter / Saunders Ave	SKE01-6	1	3	0	2	0	6	0	1	0	1.2
Apex St	Thatcher Ave	SKF01-1	1	1	1	2	1	6	1	2	0	1.2
60th St	Idylwyld Dr Service Rd	SKG01-4	4	1	0	1	0	6	0	2	0	1.2
60th St	Thatcher Ave	SKF01-5	0	2	1	0	0	3	0	0	0	0.6
68th St	Burron Ave	SKHO2-2	0	1	1	0	1	3	1	0	0	0.6
60th St	Service Rd	SKF01-4	0	0	1	0	1	2	1	0	0	0.4
Neepawa St	Thatcher Ave	SKF02-3	0	1	1	0	0	2	0	0	0	0.4
Mitchelmore Ave	Midblock	SKJ02-2	2	0	0	0	0	2	0	0	0	0.4
Arthur Rose Ave	Wheeler St	SKK01-7	1	1	0	0	0	2	0	0	0	0.4
60th St	Miners Ave	SKH01-2	0	0	1	0	0	1	0	0	0	0.2
66th St	Mitchelmore Ave	SKJ02-7	0	0	0	0	1	1	1	1	1	0.2
Kinnear Ave	Wheeler St	SKL01-7	0	0	0	1	0	1	0	0	0	0.2

Appendix F

Public Presentation – March 8th, 2021



Agriplace and Marquis Industrial Neighbourhood Traffic Review



Study Area

- Study limits
 - Highway 16
 - 71st Street
 - South Saskatchewan River
 - 60th Street
- Local and collector roads

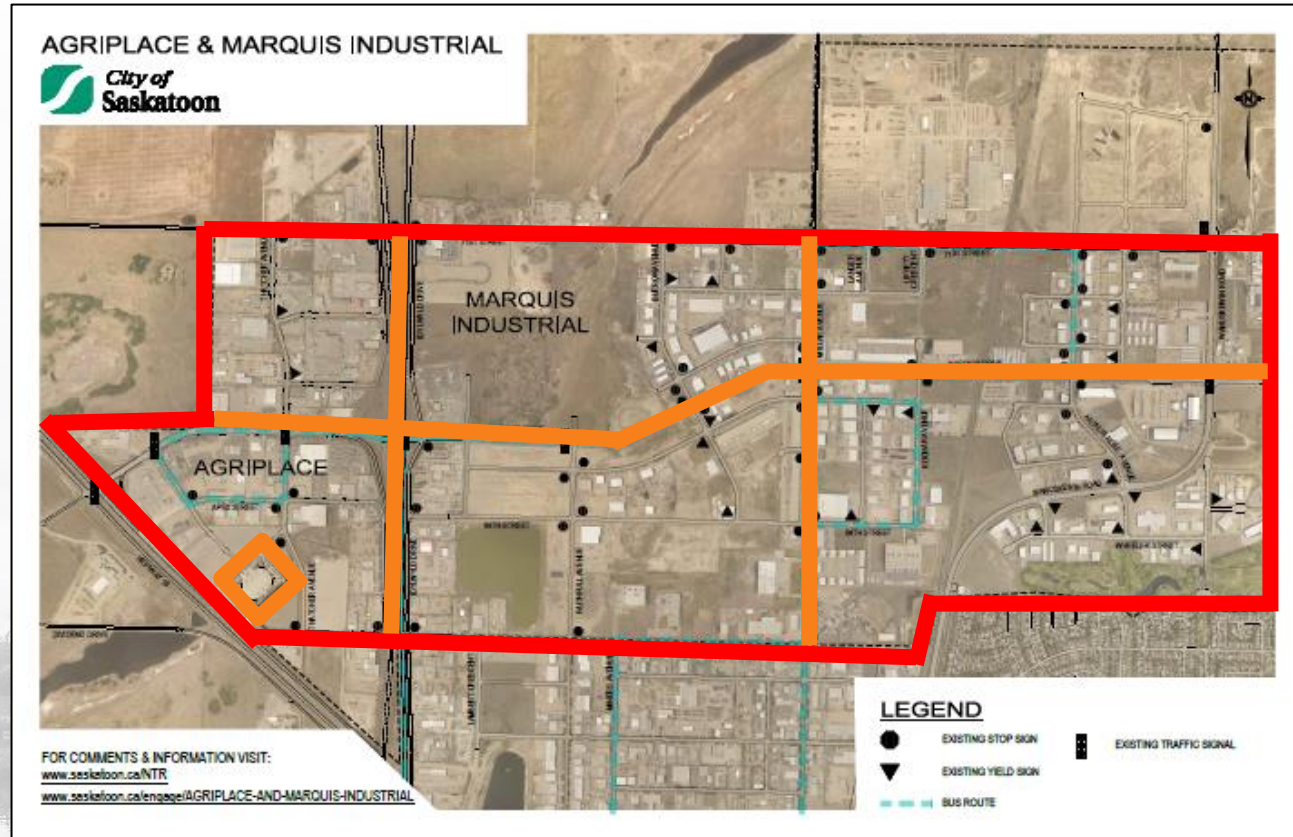

Neighbourhood Traffic Review Schedule

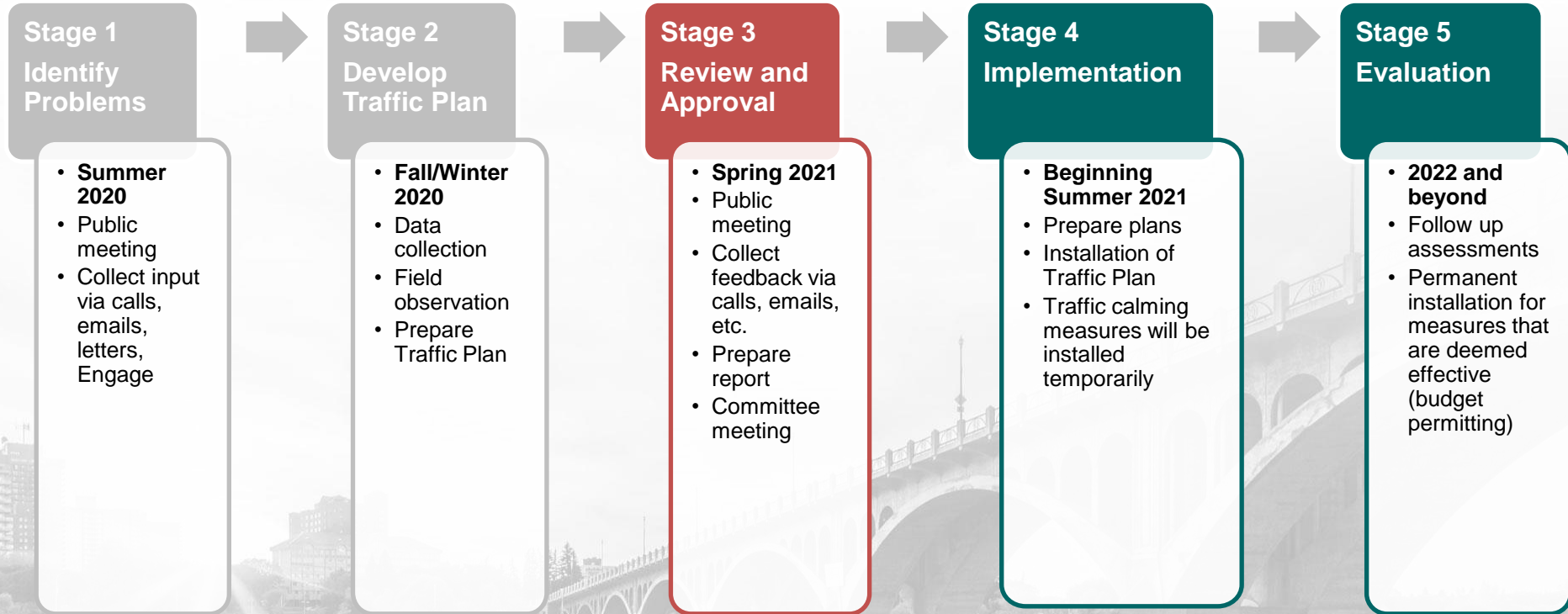

What We Heard

Speeding and Shortcutting Concerns:

- Speeding on Kinnear Ave
- Speeding on Millar Ave

What We Heard

Pedestrian Safety Concerns:

- Millar Ave
- 60th St & Faithfull Ave
- East side of Kinnear Ave
- South side of Kinnear Pl

What We Heard

Intersection Safety and Delay Concerns:

- 71st St & Idylwyld Dr
- Marquis Dr & Faithfull Ave
- Marquis Dr & Highway 11
- Marquis Dr & Highway 16
- Marquis Dr & Siemens Ave
- Marquis Dr & Thatcher Ave

What We Heard

Parking Concerns:

- Kinnear Ave & Kinnear Pl
- Lipsett Cres (Langer Ave to Lipsett Cres)

What We Heard

Other Concerns:

- Marquis Dr & Idylwyld Dr On-Ramp

What We Did

- Field observations
- Data collection:
 - 2 traffic volume / speed studies
 - 2 intersection counts
- Collision Analysis

What We Propose

- Reflective devices
- Speed display board
- Pedestrian devices
- Sidewalks

Recommendation #1

Marquis Dr & Siemens Ave

- Install reflective tape on tapered end of median on west leg

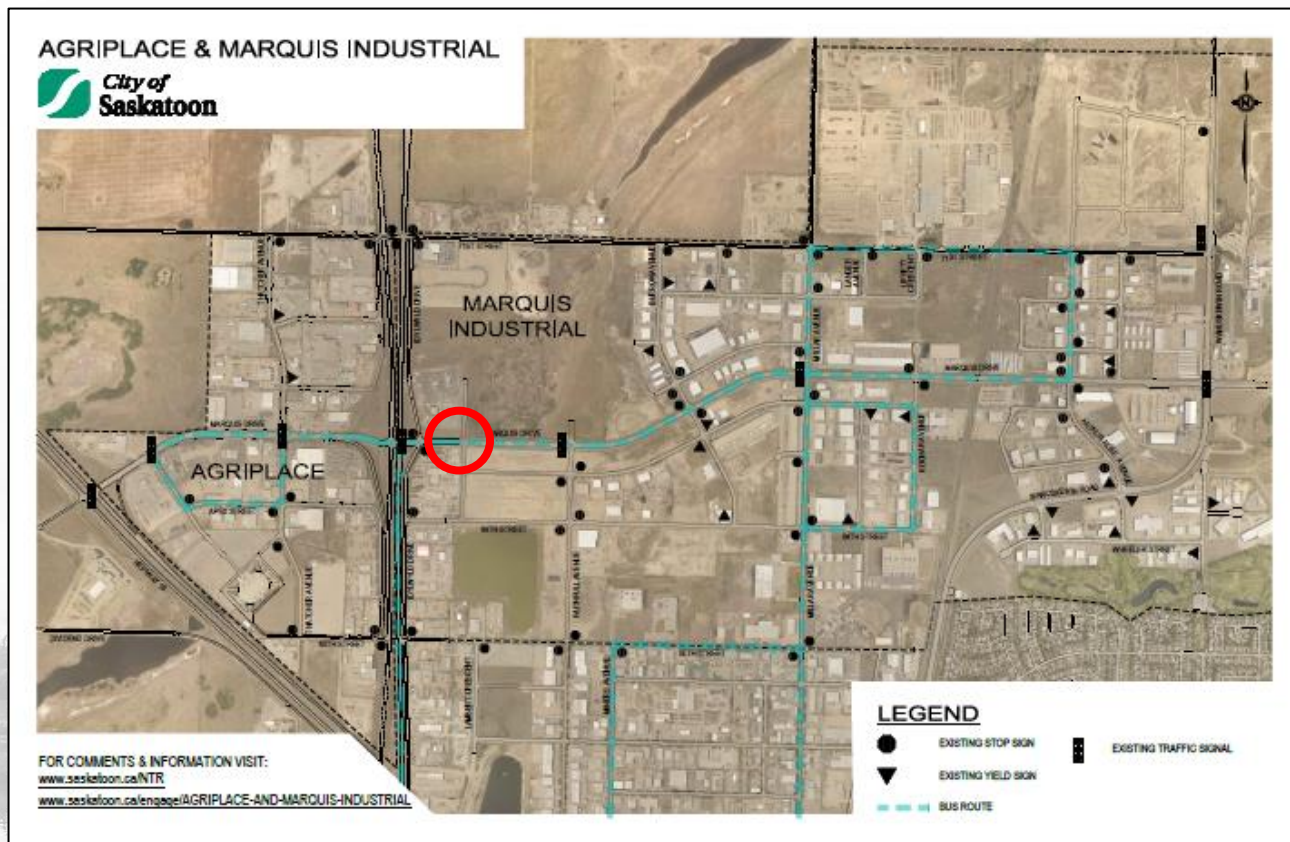

Recommendation #1

Marquis Dr & Siemens Ave

- Install reflective tape on tapered end of median on west leg



Recommendation #2

Millar Ave (60th St to 64th St)

- Install speed display board for northbound traffic
- Send speed data to Saskatoon Police Service for enforcement

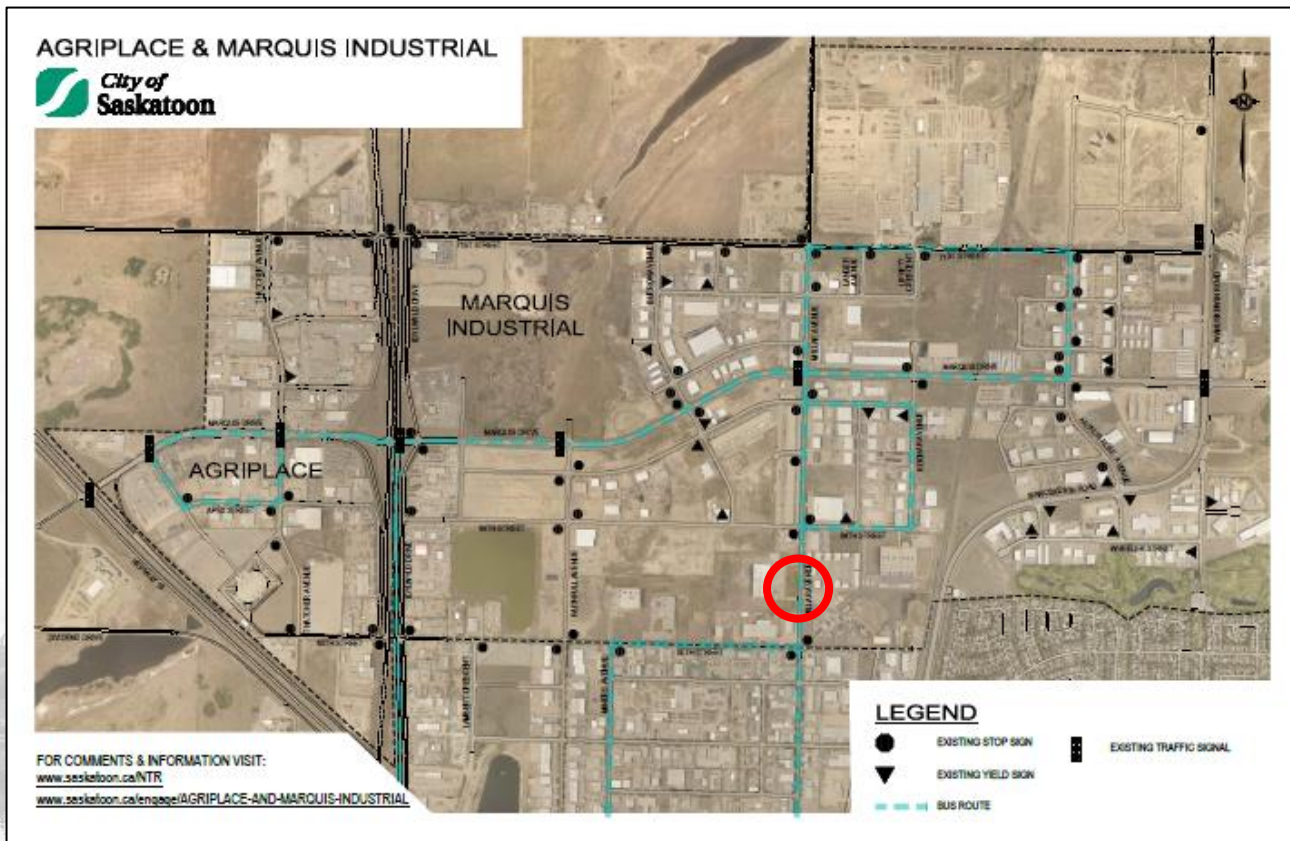

Recommendation #2

Millar Ave (60th St
to 64th St)

- Install speed display board for northbound traffic
- Send speed data to Saskatoon Police Service for enforcement

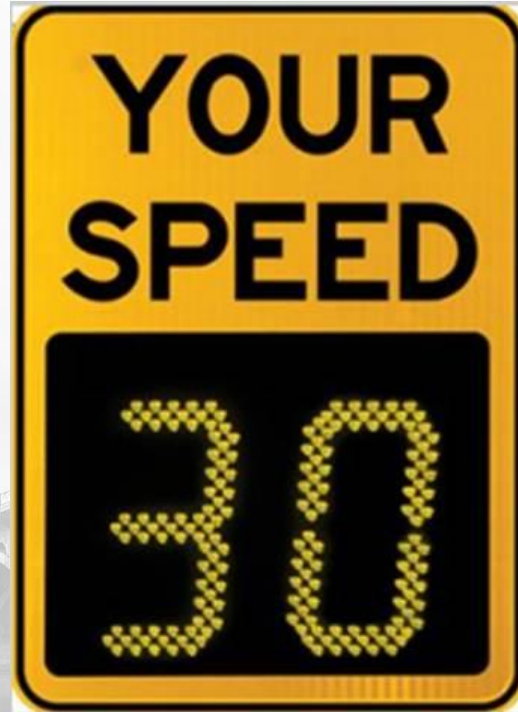

Recommendation #3

Millar Ave & 60th St

- Install Active Pedestrian Corridor on north leg

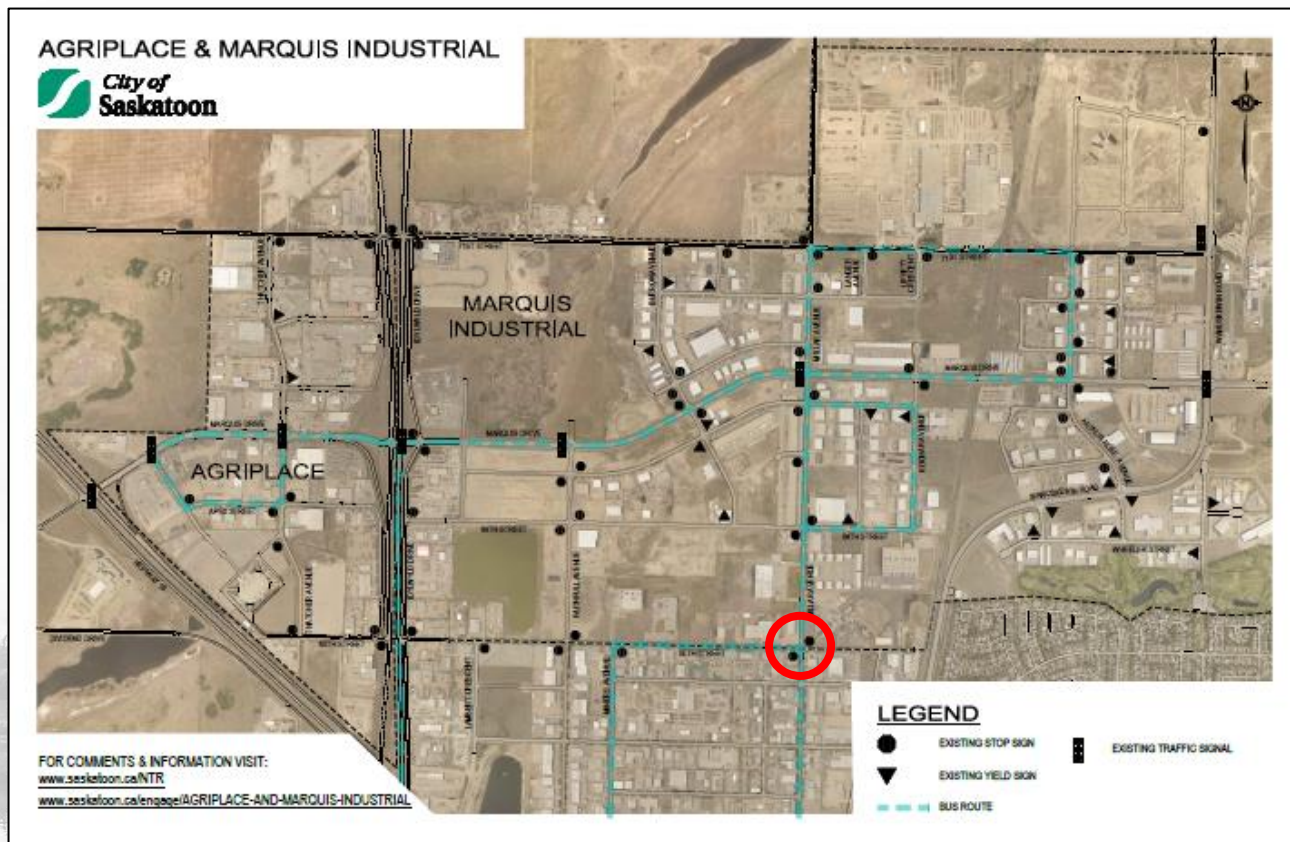

Recommendation #3

Millar Ave & 60th St

- Install Active Pedestrian Corridor on north leg



Recommendation #4

Millar Ave & 64th St

- Install Active Pedestrian Corridor on north leg

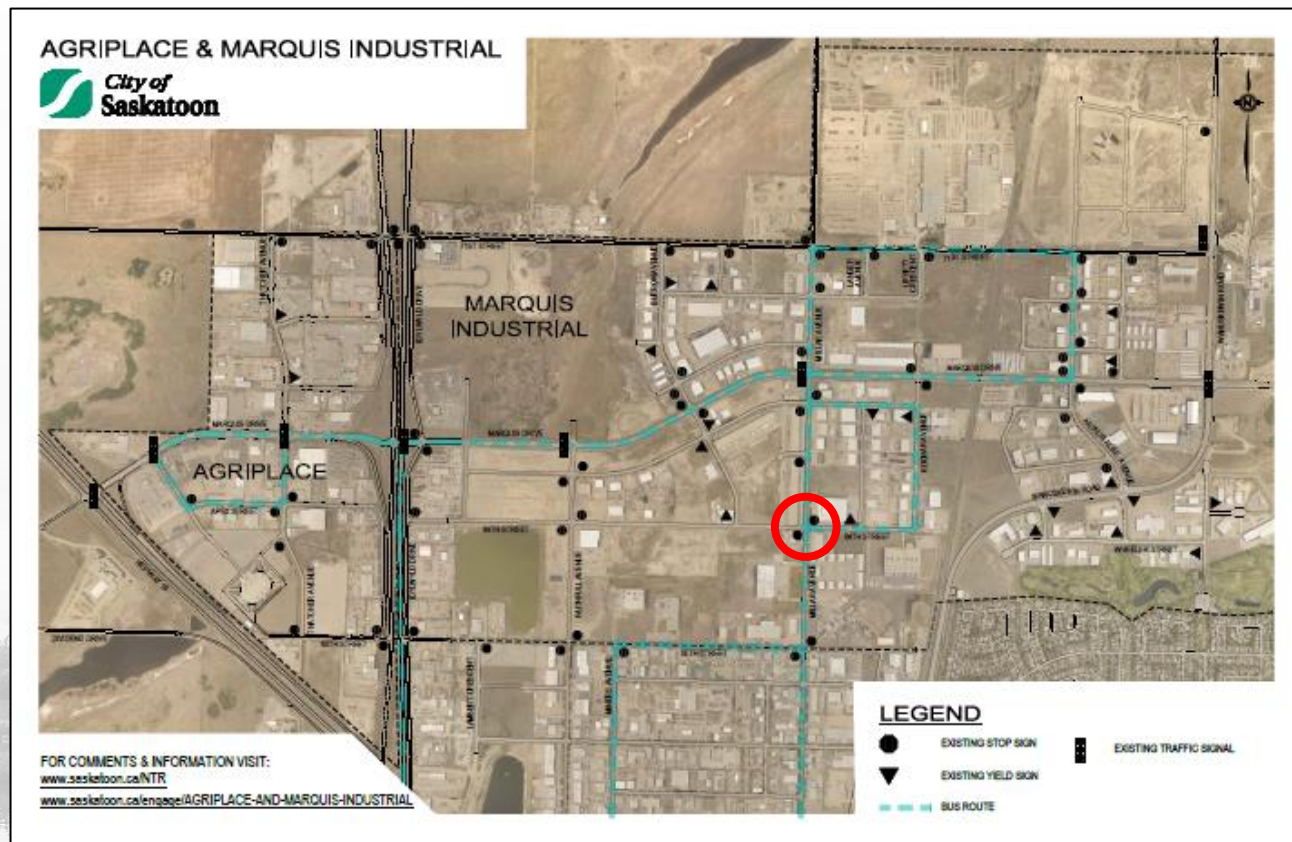

Recommendation #4

Millar Ave & 64th St

- Install Active Pedestrian Corridor on north leg



Recommendation #5 and #6

Sidewalk Infill Program

- East side of Kinnear Ave (north of Silverwood Golf Course)
- South side of Kinnear Pl (east of Kinnear Ave)

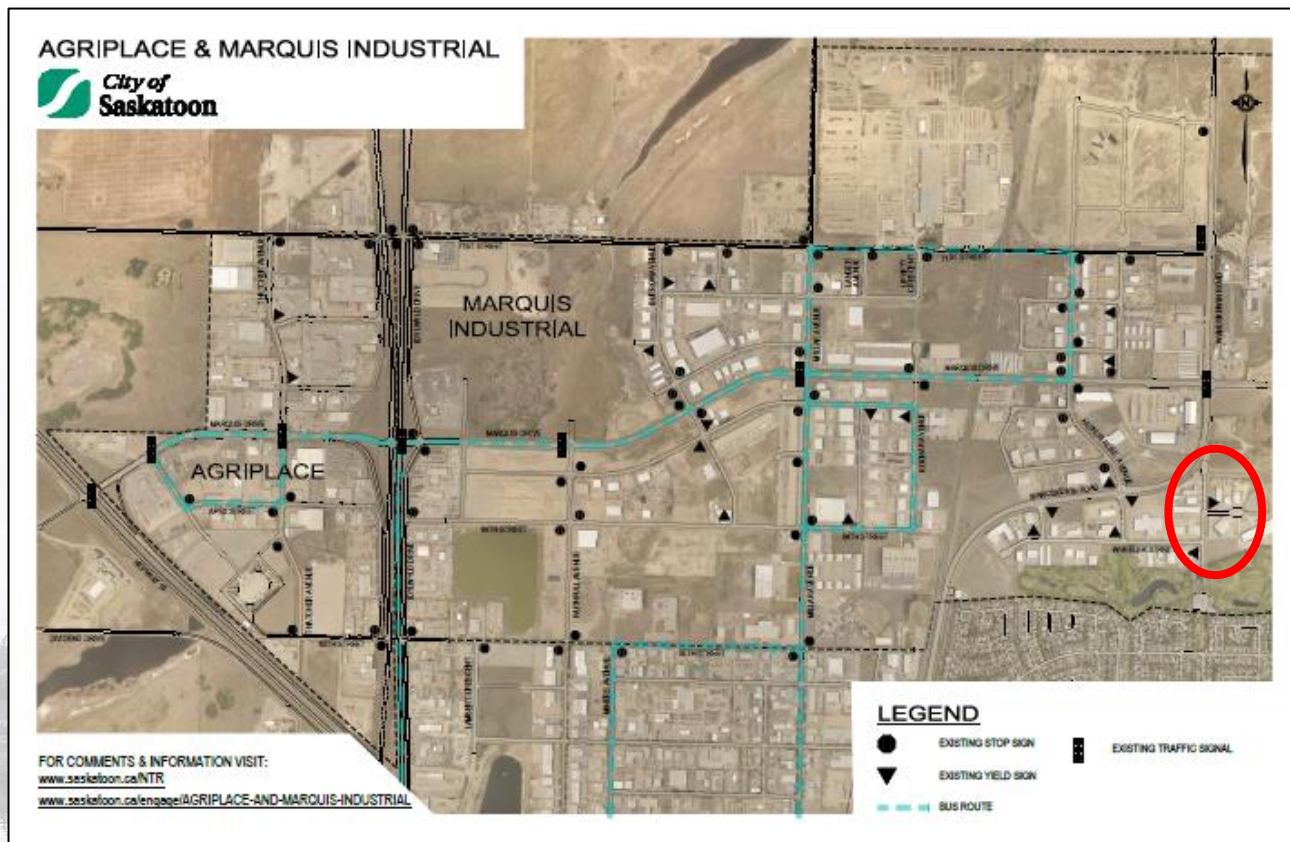

Recommendation #5 and #6

Sidewalk Infill Program

- East side of Kinnear Ave (north of Silverwood Golf Course)
- South side of Kinnear Pl (east of Kinnear Ave)



Next Steps

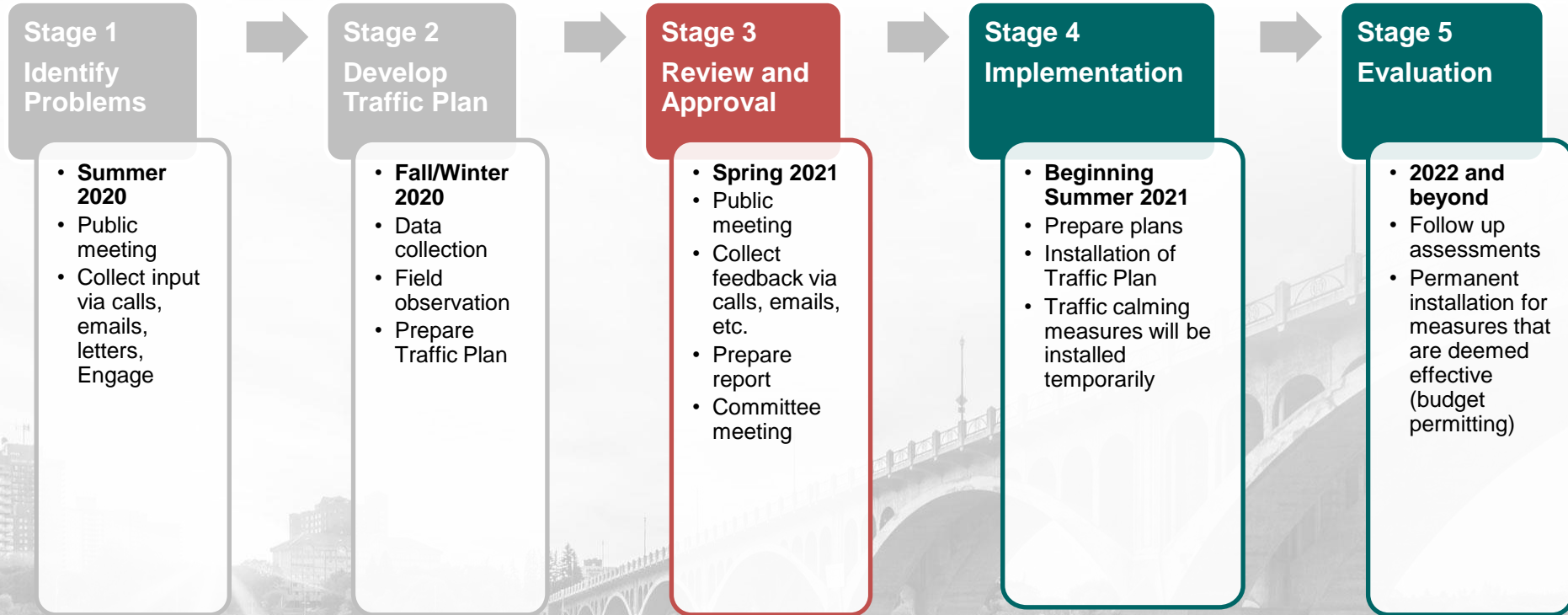

Additional Studies / Projects

- Saskatoon Freeway
 - Four-lane
 - 55-kilometre stretch
 - saskatoonfreeway.org



FUNCTIONAL DESIGN

KEY STUDY DELIVERABLES (PHASE 1)

- Finalize the route within approved corridor
- Identify land requirements
- Complete an accurate cost estimate for planning purposes
- Summarize public / stakeholder engagement input

CRITICAL FEATURES OF FUNCTIONAL DESIGN

- Public and stakeholder input
- Environmental review
- Surface drainage considerations
- Utility Impacts
- Accommodating future development / traffic

WHAT'S NEXT?

- Finalization of Phase 1
- Phase 2 Kick-off

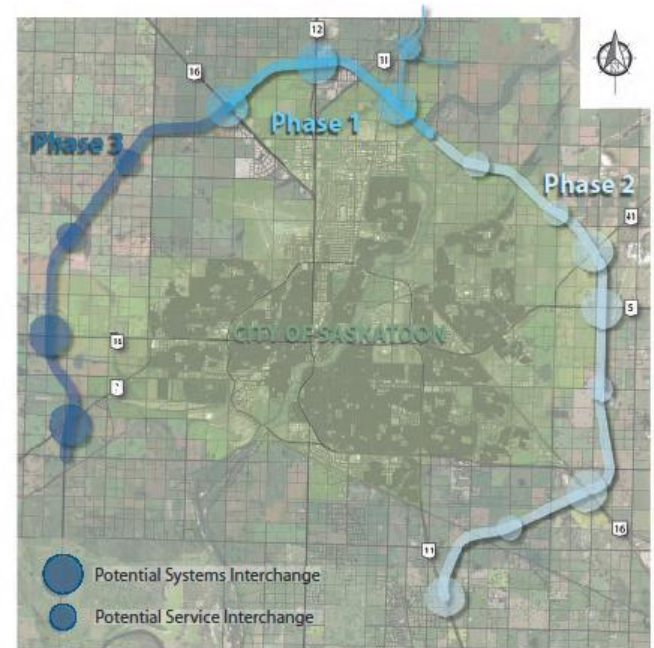

Additional Studies / Projects

- North Saskatoon Network Planning Study
 - Future arterial road and expressway connections to provincial highway system

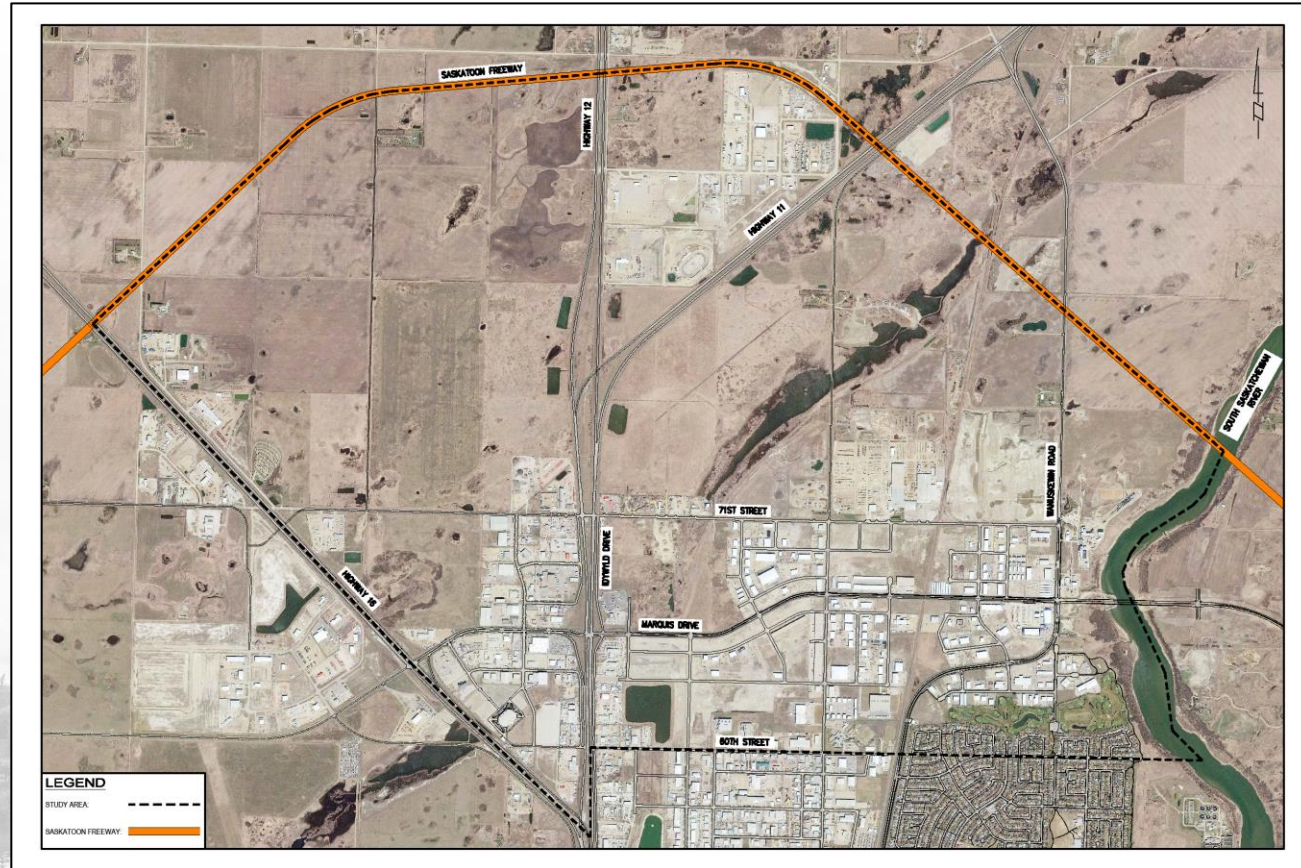

Join The Discussion

- Post comments at www.saskatoon.ca/engage
- Subscribe for updates at www.saskatoon.ca/NTR
- Report a Traffic Issue App <https://apps4.saskatoon.ca/app/aTrafficIssueReporting/>
- Call Mariniel at 306-975-3463
- Email us at ntr@saskatoon.ca
- Send us a letter

Attn: Mariniel Flores, City of Saskatoon
222 3rd Avenue North
Saskatoon, SK S7K 0J5

The screenshot shows the top navigation bar of the City of Saskatoon website with links for 'Create Account', 'Sign In', 'Accessibility', 'Engage', 'Contact Us', and 'Search'. Below the navigation bar is a horizontal menu with categories: 'Services for Residents', 'Moving Around', 'Parks, Recreation & Attractions', 'Community, Culture & Heritage', 'Business & Development', 'Environmental Initiatives', 'City Hall', and 'Election 2020'. The main content area features a large image of a street scene with trees and a stop sign. The headline reads 'Agriplace and Marquis Industrial'. Below the image is a blue banner with a white exclamation mark icon and the text: 'Click here for timely updates on how the City is responding to the COVID-19 pandemic in Saskatoon.' Below the banner is a white box with the word 'Engage' and three tabs: 'Engage', 'Background', and 'Process'. A 'Contact Us' link is located at the bottom right of the white box.

The screenshot shows the 'Neighbourhood Traffic Reviews' page on the City of Saskatoon website. The top navigation bar is identical to the previous screenshot. Below the navigation bar is a horizontal menu with categories: 'Services for Residents', 'Moving Around', 'Parks, Recreation & Attractions', 'Community, Culture & Heritage', 'Business & Development', 'New to Saskatoon', and 'City Hall'. The main content area has a breadcrumb trail: 'Home > Moving Around > Driving & Roadways > Managing Traffic > Traffic Studies > Neighbourhood Traffic Reviews'. On the left is a sidebar menu with categories: 'Accessibility', 'Transit', 'Cycling', 'Driving & Roadways', 'Winter Road Maintenance', 'Road Maintenance & Repair', 'Managing Traffic', 'Pavement Markings', 'Traffic Noise', 'Intersections', 'Merging Guidelines', 'Traffic Studies', 'Neighbourhood Traffic Reviews', 'Driving', 'Bridges', 'Walking', and 'Parking'. The main content area has the heading 'Neighbourhood Traffic Reviews' and a 'Subscribe to Traffic Review Notifications' link. The text describes the review process: 'A typical neighbourhood traffic review begins with a community meeting typically held between March and June, to engage area residents and hear about their concerns. The Transportation Division then reviews the concerns and follows up with a number of assessments such as traffic volume, speed and pedestrian studies and site observations. A list of recommendations are generated, such as signage or traffic calming measures, and presented to residents at a secondary meeting typically held between September and December of the same year. Once the plan is received and agreed upon by residents, it is then submitted to City Council for approval. Once a plan is approved by Council, the measures are implemented.' Below this text is a bulleted list of measures: 'Signage may be installed (pedestrian crosswalks, no parking, stop and yield, speed signs)', 'Traffic calming measures may be installed temporary until proven effective', and 'Sidewalks or any other permanent measures may be installed when funding is available'. At the bottom, it states: 'Online discussions are posted at [Shaping Saskatoon](#) for one month following each of the community meetings. Residents can also report neighbourhood traffic concerns by calling Transportation Customer Service at 306-975-2454 or by [completing a Community Traffic Issue report](#).'

Agriplace and Marquis Industrial Recommended Improvements

Item	Location	Recommendation	Reason
1	Marquis Drive and Siemens Avenue	Install reflective tape on tapered end of median	Improve visibility of median
2	Millar Avenue (60 th Street to 64 th Street)	Speed display board for northbound traffic	Reduce speed
		Send speed data to Saskatoon Police Service to consider for enforcement	
3	Millar Avenue and 60 th Street	Active Pedestrian Corridor on north leg	Improve pedestrian safety
4	Millar Avenue and 64 th Street	Active Pedestrian Corridor on north leg	Improve pedestrian safety
5	East side of Kinnear Avenue (north of Silverwood Golf Course)	Sidewalk and ramps to be installed as per the Sidewalk Infill Program	Improve pedestrian safety
6	South side of Kinnear Place (east of Kinnear Avenue)		

For comments & information, visit:

www.saskatoon.ca/NTR



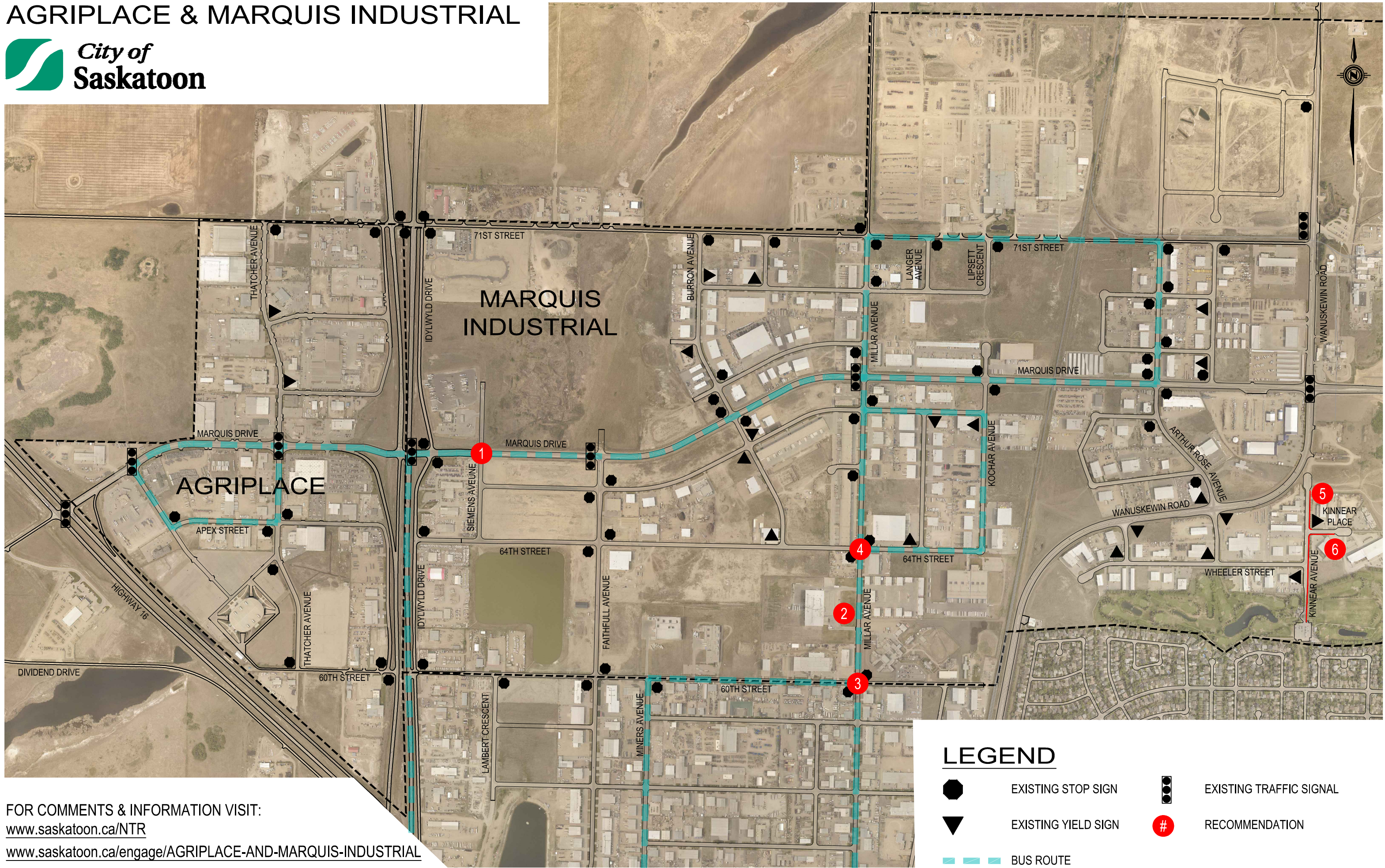

www.saskatoon.ca/engage/agriplace-and-marquis-industrial

AGRIPLACE & MARQUIS INDUSTRIAL



FOR COMMENTS & INFORMATION VISIT:
www.saskatoon.ca/NTR
www.saskatoon.ca/engage/AGRIPLACE-AND-MARQUIS-INDUSTRIAL

LEGEND

-  EXISTING STOP SIGN
-  EXISTING YIELD SIGN
-  RECOMMENDATION
-  BUS ROUTE
-  EXISTING TRAFFIC SIGNAL

Appendix G

Decision Matrix

Item	Location	Recommendation	Reason	Comments Received After Public Meeting	Decision
1	Marquis Drive and Siemens Avenue	Install reflective tape on tapered end of median	Improve visibility of median	No comments received.	Carried.
2	Millar Avenue between 60th Street and 64th Street	Install speed display board for northbound traffic	Reduce speed	No comments received.	Carried.
		Send speed data to Saskatoon Police Service for enforcement		No comments received.	Carried.
3	Millar Avenue and 60th Street	Install Active Pedestrian Corridor on north leg	Improve pedestrian safety	No comments received.	Carried.
4	Millar Avenue and 64th Street	Install Active Pedestrian Corridor on north leg	Improve pedestrian safety	No comments received.	Carried.
5	East side of Kinnear Avenue, north of Silverwood Golf Course	Sidewalk and ramps to be installed as per the Sidewalk Infill Program	Improve pedestrian safety	No comments received.	Carried.
6	South side of Kinnear Place, east of Kinnear Avenue			No comments received.	Carried.

Appendix H

Additional Concerns Received
After Presentation of Draft Plan

Location	Comments	Decision
Circle Drive and Millar Avenue	Suggests westbound right turning light	<p>Right turns on red are permitted at this intersection. As outlined in SGI's Driver Handbook, when approaching a red light, drivers must stop and remain stopped until the light changes. If the driver wants to make a right turn at an intersection, they may make the turn, but only after stopping and yielding the right of way to pedestrians and to any vehicles travelling through the intersection.</p> <p>Although making a right turn during peak hours may be difficult due to the amount of traffic on Circle Drive, there are no current plans to modify the signal timings.</p>
Idylwyld Drive and 71 st Street	Heavy traffic and collisions. Traffic signals should be installed in the future.	This intersection will be reviewed as part of the North Saskatoon Network Planning Study. This study is planning the future arterial road and expressway connections to the provincial highway system in the north part of Saskatoon.
General	Traffic plan is missing existing signals at some intersections.	The traffic plan was revised to include these existing traffic signals.

Appendix I

Public Feedback

Location	Comments
71 st Street and Idylwyld Drive	Dangerous
Idylwyld Drive	The area has too much traffic particularly during typical commute hours. Leads to traffic backups.
Marquis Drive and Highway 11	Prioritize interchange construction
Marquis Drive / Beam Road and Highway 16	Prioritize interchange construction
	Slow
General	Marquis Drive has no traffic flow. It used to be a reasonable method to reach the Costco and Martensville, but now I hit too many red lights and sometimes trains. It is faster to use Circle Drive North.
	During events, eliminate left hand turns. Also, improve access that isn't requiring someone to go around the entire building when we could have just entered at 60 th Street.

Flores, Mariniel

To: [REDACTED]
Subject: RE: TASK: Kinnear Place & Kinnear Ave Parking Restrictions

From: [REDACTED]
Sent: Thursday, May 02, 2019 7:58 AM
To: [REDACTED]
Cc: Web E-mail - Transportation [REDACTED]
Subject: RE: Saskatoon Report a Traffic Issue received

Good morning

Thank you for the email. I will forward your request for no parking signage to our Engineering section for review. I will update you with any new information I receive on this one.

Have a great day,

[REDACTED]
Customer Service Manager, Transportation
City of Saskatoon | 222 3rd Avenue North | Saskatoon, SK S7K 0J5
[REDACTED]
www.saskatoon.ca

From: City of Saskatoon [<mailto:Transportation@Saskatoon.ca>]
Sent: Monday, April 29, 2019 9:55 AM
To: Web E-mail - Transportation <Transportation@Saskatoon.ca>
Subject: Saskatoon Report a Traffic Issue received



New Traffic Issue Reported!

Request ID: [REDACTED]

Issues: TRAFFIC SAFETY, PARKING SIGNAGE,

Name: [REDACTED]

Email: [REDACTED]

Phone: [REDACTED]

Comment: Large trucks are parking very close to the corner of Kinnear Place and Kinnear Ave. When turning left from Kinnear Place on to Kinnear Ave the view is completely obstructed [REDACTED]
[REDACTED]. A "no-parking" sign on Kinnear Avenue to prevent large trucks from parking so close to that corner is important before a serious accident occurs.

Attachment:

Flores, Mariniel

From: [REDACTED]
Sent: Wednesday, August 28, 2019 5:17 PM
To: City of Saskatoon - Neighbourhood Traffic Reviews
Subject: Traffic Rates

Hello,

I was wondering if the city has done a traffic count on the corner of Marquis Drive and Wanuskewin Road since the new bridge has gone in? And if so, how would I be able to see those numbers?

Thank you

[REDACTED]

Sent from my iPad

Flores, Mariniel

From: [REDACTED]
Sent: Tuesday, November 19, 2019 3:46 PM
To: [REDACTED]
Subject: RE: Pedestrian crossing enhancement

Hi [REDACTED]

We use the TAC Pedestrian Crossing Control Guide to identify all pedestrian crossing devices. We included an RRFB at Millar Avenue & 43rd Street as part of the RRFB pilot project; however, based on the TAC guide and the traffic volume on the street, it will be upgraded to an active pedestrian corridor.

A neighbourhood traffic review for the Marquis Industrial Area is scheduled to take place in 2020. I will log your concern at the intersection of Millar Avenue & 64th Street to be considered as part of the review.

We have many compliance issues with pedestrian crossings in our industrial areas because drivers are not expecting pedestrians to be present. Implementation of missing sidewalks is completed through our Active Transportation Implementation Plan.

Regards,

[REDACTED]
[REDACTED] [REDACTED]
Senior Transportation Engineer
City of Saskatoon | 222 3rd Avenue North | Saskatoon, SK S7K 0J5
Treaty 6 Territory & Homeland of the Métis
[REDACTED]
www.saskatoon.ca

*If you receive this email in error, please do not review, distribute or copy the information.
Please contact the sender and delete the message and any attachments*

From: [REDACTED]
Sent: Tuesday, November 19, 2019 3:21 PM
To: [REDACTED]
Subject: Pedestrian crossing enhancement

Hey [REDACTED]

I was wondering if you could tell me if the City has a warrant process for the using the rapid flashing rectangular LED beacons at cross walks?

Are you using the TAC Pedestrian Control Guide?

My interest is twofold. One the cross walk in front of our office on Millar is a death trap. I regularly use it and rarely have drivers slow down and give me the right of way. I would love to see the rapid flash beacons installed at that location.

The other reason is that I have a couple design projects [REDACTED], where crosswalks will be required and our current crosswalk standards are pretty dated.

Thanks for your help.

Regards,

[REDACTED]

[REDACTED]
Saskatoon, Sk, [REDACTED]

[REDACTED]

CONFIDENTIALITY NOTICE:

This email (and any attachment) was intended for a specific recipient(s). It may contain information that is privileged, confidential or exempt from disclosure. Any privilege that exists is not waived. If you are not the intended recipient, do not copy or distribute it to another person or use it for any other purpose. Please delete it and advise me by return email or telephone. Thank you.

Flores, Mariniel

From: Flores, Mariniel
Sent: Thursday, August 13, 2020 9:53 AM
To: [REDACTED]
Cc: City of Saskatoon - Neighbourhood Traffic Reviews
Subject: RE: FYI Traffic concerns for Marquis Industrial.

Hello [REDACTED].

Thank you for providing your comments.

Although this is outside of the Agriplace and Marquis Industrial neighbourhood traffic review study area, we will forward this concern to our traffic signal specialists for investigation.

We will continue to receive comments through emails, phone calls, letters, the Report a Traffic Issue app, the Engage Page, and at the upcoming public meeting on August 20, 2020. All comments received will be compiled and used to identify locations for data collection such as traffic volume, speed and pedestrian studies, and site observations.

Thank you again for your email.

Mariniel Flores, P.Eng. | [tel 306.975.3463](tel:306.975.3463)

Transportation Engineer
Transportation, Transportation & Construction Department
City of Saskatoon | 222 3rd Avenue North | Saskatoon, SK S7K 0J5
Treaty 6 Territory & Homeland of the Metis
mariniel.flores@saskatoon.ca
www.saskatoon.ca

*If you receive this email in error, please do not review, distribute or copy the information.
Please contact the sender and delete the message and any attachments.*

From: [REDACTED]
Sent: Friday, August 07, 2020 9:35 AM
To: City of Saskatoon - Neighbourhood Traffic Reviews <NTR@Saskatoon.ca>
Subject: FYI Traffic concerns for Marquis Industrial.

To whom it may concern,

At the corner of Warman road/ Wunuskewin road and 51st, when you are in the turning lane coming from Warman, heading southbound and you are trying to turn left, to head toward the River, so trying to turn East, there is an arrow from the other direction that reflects onto the green light, the freaky thing is that at the exact right time of the day, it looks like the person turning left has an arrow, so they go, but they didn't have an arrow, it was blinking and reflecting onto the green only light.

If this happens, then someone will go thinking they have an arrow, but in reality they don't and boom I am convinced that is why there are so many traffic signs there The lights are not lined up properly to avoid the reflection. Please put someone on this, the sun has to be at the right angle and it is not all times of the day, so please do not dismiss this until you see exactly what I am talking about and have seen this atleast half a dozen times.

[REDACTED]

[REDACTED]

[REDACTED]

[REDACTED]

[REDACTED]

[REDACTED]

Flores, Mariniel

From: Flores, Mariniel
Sent: Thursday, August 13, 2020 9:54 AM
To: [REDACTED]
Cc: City of Saskatoon - Neighbourhood Traffic Reviews
Subject: RE: Intersection Marquis Drive and Siemens Ave

Hello [REDACTED].

Thank you for providing your comments regarding traffic in the Agriplace and Marquis Industrial neighbourhood.

Your suggestions at Marquis Drive and Siemens Avenue have been noted and added to the project file. This will be investigated as part of the neighbourhood traffic review.

We will continue to receive comments through emails, phone calls, letters, the Report a Traffic Issue app, the Engage Page, and at the upcoming public meeting on August 20, 2020. All comments received will be compiled and used to identify locations for data collection such as traffic volume, speed and pedestrian studies, and site observations.

Thank you again for your email.

Mariniel Flores, P.Eng. | [tel 306.975.3463](tel:306.975.3463)

Transportation Engineer
Transportation, Transportation & Construction Department
City of Saskatoon | 222 3rd Avenue North | Saskatoon, SK S7K 0J5
Treaty 6 Territory & Homeland of the Metis
mariniel.flores@saskatoon.ca
www.saskatoon.ca

*If you receive this email in error, please do not review, distribute or copy the information.
Please contact the sender and delete the message and any attachments.*

From: [REDACTED]
Sent: Friday, August 7, 2020 12:28 PM
To: Flores, Mariniel <Mariniel.Flores@Saskatoon.ca>
Subject: Intersection Marquis Drive and Siemens Ave

Hi Mariniel

I have a suggestion for you that is a simple fix. When proceeding west on Marquis through the intersection at Siemens Ave the center boulevard protrudes outward into the left hand lane.that protects the light standard, Could there be some reflectors or reflective tape put on the concrete dividers? When driving at dusk or evening these barriers are deceiving.

Thank you.

--

Flores, Mariniel

To: Web E-mail - Transportation
Subject: RE: Saskatoon Report a Traffic Issue received

From: City of Saskatoon [REDACTED]
Sent: Thursday, August 27, 2020 8:46 AM
To: Web E-mail - Transportation [REDACTED]
Subject: Saskatoon Report a Traffic Issue received

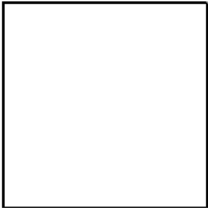

New Traffic Issue Reported!

Request ID: [REDACTED]

Issues: CYCLING SAFETY, PEDESTRIAN SAFETY,

Name: [REDACTED]

Email: [REDACTED]

Phone: [REDACTED]

Comment: There are many pedestrians and cyclists walking on the road itself between the Silverwood Golf course to the dog park and Meewasin trail at the end of Kinnear Place or on Kinnear Ave. There is a sidewalk on the west side, but not the east side of the road. There are many semis and large trucks driving here not to mention speeding cars. The east side of Kinnear Ave and south side of Kinnear Place desperately need a sidewalk. There are also frequently trucks parked so visibility is poor.

Attachment:

Flores, Mariniel

From: [REDACTED]
Sent: Wednesday, February 24, 2021 2:59 PM
To: Flores, Mariniel
Subject: RE: pedestrian/equipment traffic - [REDACTED]

[Warning: This email originated outside our email system. Do not click links or open attachments unless you recognize the sender and know the content is safe.]

We're the only ones who cross here. We are very safe when we do so and always ensure we are giving the right of way to traffic so as not to cause problems.

I'm satisfied with the outcome and decision, it was just a thought an employee had and definitely worth exploring.

I appreciate the timely responses and thought into the matter.

[REDACTED]

[REDACTED]

[REDACTED]
[REDACTED]
[REDACTED]
[REDACTED]

[REDACTED]
Saskatoon, SK [REDACTED]
[REDACTED]

From: Flores, Mariniel [mailto:Mariniel.Flores@Saskatoon.ca]
Sent: Wednesday, February 24, 2021 2:54 PM
To: [REDACTED]
Subject: [EXTERNAL]RE: pedestrian/equipment traffic - [REDACTED]

Hi [REDACTED].

Thank you for the clarification. Perhaps you are thinking of warning signs.

This mid-block location on Neepawa Street was reviewed and site visits were completed. Neepawa Street is a local roadway with adequate visibility and sight lines of your accesses so warning signs are not recommended.

In addition, this has not been raised as a location of concern from others through the Agriplace and Marquis Industrial Neighbourhood Traffic Review (NTR).

If you have any other concerns, please do not hesitate to contact me. We will continue to receive comments through emails, phone calls, letters, the Report a Traffic Issue app, and the Engage Page for the Agriplace and Marquis Industrial NTR.

Have a good day.

Regards,

Mariniel Flores, P.Eng. | tel 306.975.3463

Transportation Engineer
Transportation, Transportation & Construction Division
City of Saskatoon | 222 3rd Avenue North | Saskatoon, SK S7K 0J5
Treaty 6 Territory & Homeland of the Metis
mariniel.flores@saskatoon.ca
www.saskatoon.ca

*If you receive this email in error, please do not review, distribute or copy the information.
Please contact the sender and delete the message and any attachments.*

From [REDACTED]
Sent: Tuesday, February 23, 2021 1:08 PM
To: Flores, Mariniel <Mariniel.Flores@Saskatoon.ca>
Subject: RE: pedestrian/equipment traffic - [REDACTED]

[Warning: This email originated outside our email system. Do not click links or open attachments unless you recognize the sender and know the content is safe.]

Mid-block. Our main yard is on the corner of Thatcher and Neepawa, and we have a second yard we use for storage across the Neepawa (located on the other corner of Neepawa and Thatcher). Both compounds are gated.

Generally speaking we have only had very, very minor issues so I would understand if this fell outside the parameters for signage.

I'm not even sure what signage would be needed, we certainly are not looking for right-of-way usage.



[REDACTED]

[REDACTED]

[REDACTED]

[REDACTED]

[REDACTED]

[REDACTED]

[REDACTED]

[REDACTED]

[REDACTED]

-----Original Message-----

From: Flores, Mariniel [<mailto:Mariniel.Flores@Saskatoon.ca>]

Sent: Tuesday, February 23, 2021 12:57 PM

To: [REDACTED]

Subject: [EXTERNAL]RE: pedestrian/equipment traffic - [REDACTED]

Good afternoon, Johnathan.

I am reviewing your request as part of the Agriplace and Marquis Industrial Neighbourhood Traffic Review. I would like to gather some more information.

Where on Thatcher Avenue are your employees crossing? Mid-block or at the intersection of Thatcher Avenue and Neepawa Street?

Regards,

Mariniel Flores, P.Eng. | tel 306.975.3463 Transportation Engineer Transportation, Transportation & Construction Division City of Saskatoon | 222 3rd Avenue North | Saskatoon, SK S7K 0J5 Treaty 6 Territory & Homeland of the Metis
mariniel.flores@saskatoon.ca www.saskatoon.ca

If you receive this email in error, please do not review, distribute or copy the information. Please contact the sender and delete the message and any attachments.

-----Original Message-----

From: Web NoReply

Sent: Tuesday, September 15, 2020 4:02 PM

To: Web E-mail - Transportation <Transportation@Saskatoon.ca>

Subject: pedestrian/equipment traffic - [REDACTED]

--- Replies to this email will go to [REDACTED] ---

Submitted on Tuesday, September 15, 2020 - 16:02 Submitted by user: Anonymous Submitted values are:

==Your Message==

Service category: Traffic Issues

Account Number:

Subject: pedestrian/equipment traffic - [REDACTED]

Message:

Good afternoon, my name is [REDACTED]

[REDACTED] We operate on two different lots on Thatcher Avenue and we store equipment on both lots. We are back and forth between both lots with equipment and as pedestrians frequently each day. I am exploring the possibility of signage for moving equipment and pedestrians facing each direction of traffic as a safety precaution for my employees. Not a crosswalk or anything like, more of a caution type sign. We have not had any issues in the seven years we have been here, but depending on the piece of equipment it can be difficult if it is slower moving and large to see. We do exercise a great deal of caution when crossing and always provide the right of way to traffic. I guess what the question is, does the city provide any signage? If not am I able to get signage from the city what are the regulations surrounding [REDACTED] putting signage up given that anything outside our fence line will be on an easement or city property. I'm not sure if this is directed at the correct group, if not, please disregard and if possible provide me with the correct contact information.

Thanks in advance,

[REDACTED]
Attachment:

==Your Details==

First Name [REDACTED]

Last Name: [REDACTED]

Email: [REDACTED]

Confirm Email: [REDACTED]m

Neighbourhood where you live: [REDACTED] [REDACTED]

For internal use only :

[REDACTED]

Flores, Mariniel

From: Flores, Mariniel
Sent: Thursday, March 18, 2021 9:08 AM
To: [REDACTED]
Cc: City of Saskatoon - Neighbourhood Traffic Reviews
Subject: RE: Traffic Lights

Hello [REDACTED]

Thank you for providing your comments regarding neighbourhood traffic for Agriplace and Marquis Industrial.

The intersection of Idylwyld Drive and 71st Street will be reviewed as part of the North Saskatoon Network Planning Study. This study is planning the future arterial road and expressway connections to the provincial highway system in the north part of Saskatoon. The materials presented at the first open house for the study are available [here](#). The planning study is dependent on the recommendations for the [Saskatoon Freeway](#) project.

The Ministry of Highways and Infrastructure is working on a planning study for the [Saskatoon Freeway](#) which is expected to be a four-lane, 55-kilometre stretch of divided highway that begins at Highway 11 south of Saskatoon and connects with Highway 7 west of the city shown on this slide. Phase 1 of the study covers the portion of the corridor at the north end of Saskatoon. The final report of the Phase 1 study is currently under review.

We will continue to receive comments at the public meeting, and through emails, phone calls, letters, the Report a Traffic Issue app, and the Engage Page. All comments received will be considered as the traffic plan is finalized.

Thank you again for your email. Have a good day.

Mariniel Flores, P.Eng. | tel 306.975.3463

Transportation Engineer
Transportation, Transportation & Construction Division
City of Saskatoon | 222 3rd Avenue North | Saskatoon, SK S7K 0J5
Treaty 6 Territory & Homeland of the Metis
mariniel.flores@saskatoon.ca
www.saskatoon.ca

*If you receive this email in error, please do not review, distribute or copy the information.
Please contact the sender and delete the message and any attachments.*

From: [REDACTED]
Sent: Wednesday, March 17, 2021 8:54 AM
To: Flores, Mariniel <Mariniel.Flores@Saskatoon.ca>
Subject: Traffic Lights

[Warning: This email originated outside our email system. Do not click links or open attachments unless you recognize the sender and know the content is safe.]

Good Morning Mariniel!!

Hope you are having a good day! 😊

I have a question for you, is there any plans for putting in lights at 71st and Idylwyld?

I live in Martensville and turn at that intersection to come to work every day. I can't tell you the amount of times I thought someone was going to die at the intersection. Especially the traffic going westbound towards PBR in the mornings. There is a lot of traffic coming in from Warman and Martensville, and the turning lane is always full of cars. I don't know how they can cross there, you can't see down the highway. This has been a problem intersection since I was little, [REDACTED]. When I got my license back in the day, my dad would never let me cross at that intersection. This is the same problem that they had on the highway 11 and Wanuskewin. They finally fixed that one after one big accident, that took a few lives. I don't think we should have to wait for that to happen for someone to fix this intersection.

I watched your video this morning, and there wasn't any mention on fixing that part.

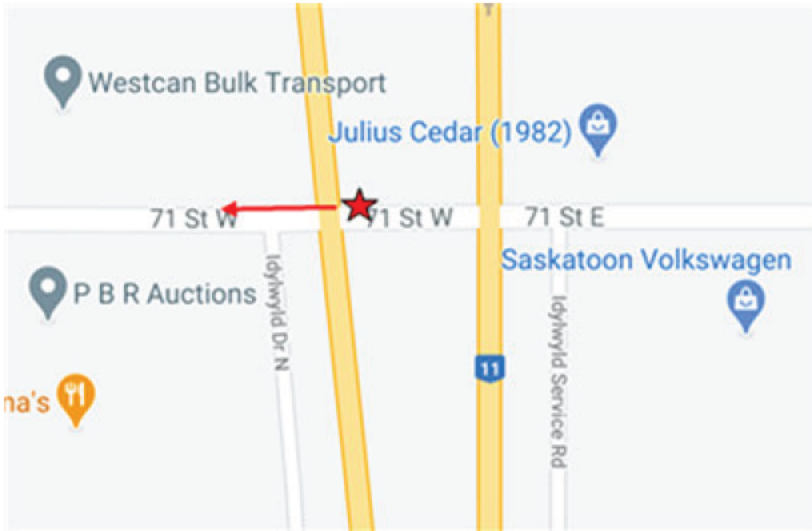

Look forward to your response,
Have a great day!
Thanks,

[REDACTED]

[REDACTED]

[REDACTED]

Flores, Mariniel

From: Flores, Mariniel
Sent: Thursday, March 18, 2021 9:04 AM
To: [REDACTED]
Cc: City of Saskatoon - Neighbourhood Traffic Reviews
Subject: RE: Agriplace & Marquis Industrial

Hello [REDACTED].

Thank you for providing your comments regarding neighbourhood traffic for Agriplace and Marquis Industrial.

The intersection of Idylwyld Drive and 71st Street will be reviewed as part of the North Saskatoon Network Planning Study. This study is planning the future arterial road and expressway connections to the provincial highway system in the north part of Saskatoon. The materials presented at the first open house for the study are available [here](#). The planning study is dependent on the recommendations for the [Saskatoon Freeway](#) project.

The Ministry of Highways and Infrastructure is working on a planning study for the [Saskatoon Freeway](#) which is expected to be a four-lane, 55-kilometre stretch of divided highway that begins at Highway 11 south of Saskatoon and connects with Highway 7 west of the city shown on this slide. Phase 1 of the study covers the portion of the corridor at the north end of Saskatoon. The final report of the Phase 1 study is currently under review.

We will continue to receive comments at the public meeting, and through emails, phone calls, letters, the Report a Traffic Issue app, and the Engage Page. All comments received will be considered as the traffic plan is finalized.

Thank you again for your email.

Mariniel Flores, P.Eng. | [tel 306.975.3463](tel:306.975.3463)

Transportation Engineer
Transportation, Transportation & Construction Division
City of Saskatoon | 222 3rd Avenue North | Saskatoon, SK S7K 0J5
Treaty 6 Territory & Homeland of the Metis
mariniel.flores@saskatoon.ca
www.saskatoon.ca

*If you receive this email in error, please do not review, distribute or copy the information.
Please contact the sender and delete the message and any attachments.*

From: [REDACTED]
Sent: Wednesday, March 17, 2021 7:47 AM
To: Flores, Mariniel <Mariniel.Flores@Saskatoon.ca>
Subject: Agriplace & Marquis Industrial

[Warning: This email originated outside our email system. Do not click links or open attachments unless you recognize the sender and know the content is safe.]

Good Morning!

Just received the engage flyer in the mail from the city of Saskatoon.

I would strongly encourage you and your colleagues to study the intersection of Idylwyld Drive and 71st Street. We get very heavy traffic here, heading both ways. The number of preventable accidents I myself have personally seen is quite concerning. I think in the future, lights should be installed at this intersection.

Thank you,

[Redacted signature]

[Redacted address]

Flores, Mariniel

From: Flores, Mariniel
Sent: Thursday, March 18, 2021 4:20 PM
To: [REDACTED]
Cc: City of Saskatoon - Neighbourhood Traffic Reviews
Subject: RE: Traffic Plan

Hello [REDACTED]

Thank you for providing your comments regarding the intersection of Millar Avenue and Circle Drive.

Right turns on red are permitted at this intersection. As outlined in SGI's [Driver Handbook](#), when approaching a red light, drivers must stop and remain stopped until the light changes. If the driver wants to make a right turn at an intersection, they may make the turn, but only after stopping and yielding the right of way to pedestrians and to any vehicles travelling through the intersection.

Although making a right turn during peak hours may be difficult due to the amount of traffic on Circle Drive, there are no current plans to modify the signal timings.

We will be presenting a [Transportation Master Plan](#) to City Council on Monday (Item 8.4.1). As shown in Appendix D, the section of Circle Drive between Idylwyld Drive and Warman Road is on the list of Transportation Infrastructure Projects.

We will continue to receive comments at the public meeting, and through emails, phone calls, letters, the Report a Traffic Issue app, and the Engage Page. All comments received will be considered as the traffic plan is finalized.

Thank you again for your email.

Mariniel Flores, P.Eng. | tel 306.975.3463

Transportation Engineer
Transportation, Transportation & Construction Division
City of Saskatoon | 222 3rd Avenue North | Saskatoon, SK S7K 0J5
Treaty 6 Territory & Homeland of the Metis
mariniel.flores@saskatoon.ca
www.saskatoon.ca

*If you receive this email in error, please do not review, distribute or copy the information.
Please contact the sender and delete the message and any attachments.*

From: [REDACTED]
Sent: Wednesday, March 17, 2021 10:55 AM
To: Flores, Mariniel <Mariniel.Flores@Saskatoon.ca>
Subject: Traffic Plan

[Warning: This email originated outside our email system. Do not click links or open attachments unless you recognize the sender and know the content is safe.]

Hi Mariniel,

I work in the North end in Saskatoon. In the mail yesterday we received a letter talking about the traffic plan for our area. I was looking on the websites that are mentioned on the letter to find the area where the turn off of North Circle

onto Millar (where Wheaton GM is) would be as it is just outside our area on the map. I think it would be very beneficial to have a right turning light at that intersection. When people turning off of Millar left onto Circle Drive have a left arrow, it allows people turning right onto Millar to continue, which would help with the flow of traffic immensely during morning rush hour. I am not sure if the City is considering traffic in that area during this time. I thought I would submit my suggestion just in case.

Thank you,

██████████

Flores, Mariniel

To: [REDACTED]
Subject: RE: Saskatoon Report a Traffic Issue received

From: City of Saskatoon [REDACTED]
Sent: Sunday, August 16, 2020 1:04 PM
To: Web E-mail - Transportation [REDACTED]
Subject: Saskatoon Report a Traffic Issue received



New Traffic Issue Reported!

Request ID: [REDACTED]

Issues: TRAFFIC SAFETY,

Name: [REDACTED]

Email: [REDACTED]

Phone:

Comment: Was the rate of transition for Marquis Dr. Eastbound traffic at the posted speed of 60km/h checked to be compliant with design best practices? The other direction is not as bad.

Attachment:

Flores, Mariniel

To: Flores, Mariniel
Subject: RE: Call answered by another user.

- Maps are missing existing traffic signals at some intersections

From: [REDACTED]
Sent: Tuesday, March 16, 2021 10:35 AM
To: Flores, Mariniel <Mariniel.Flores@Saskatoon.ca>
Subject: Call answered by another user.

Call for you from [REDACTED] by .